

The power behind competitiveness

Delta UPS Ultron Family

HPH Series, Three Phase
20/ 30/ 40 kVA

User Manual

SAVE THIS MANUAL

This manual contains important instructions and warnings that you should follow during the installation, operation, storage and maintenance of this product. Failure to heed these instructions and warnings will void the warranty.

Copyright © 2023 by Delta Electronics Inc. All Rights Reserved. All rights of this User Manual ("Manual"), including but not limited to the contents, information, and figures are solely owned and reserved by Delta Electronics Inc. ("Delta"). The Manual can only be applied to the operation or the use of this product. Any disposition, duplication, dissemination, reproduction, modification, translation, extraction, or usage of this Manual in whole or in part is prohibited without the prior written permission of Delta. Given that Delta will continuously improve and develop the product, changes may be made to the information in this Manual at any time without obligation to notify any person of such revision or changes. Delta will make all possible efforts to secure the accuracy and the integrity of this Manual. Delta disclaims any kinds or forms of warranty, guarantee, or undertaking, either expressly or implicitly, including but not limited to the completeness, faultlessness, accuracy, non-infringement, merchantability or fitness for a particular purpose of the Manual.

Table of Contents

Chapter 1: Important Safety Instructions	5
1.1 Installation Warnings	5
1.2 Connection Warnings	5
1.3 Usage Warnings	5
1.4 Storage Warnings.....	6
1.5 Standard Compliance.....	7
Chapter 2: Introduction	8
2.1 Product Introduction	8
2.2 Package Inspection	8
2.3 Functions and Features.....	9
2.4 Appearance and Dimensions	11
2.5 Front Panel.....	11
2.6 Rear Panel	13
Chapter 3: Operation Modes	17
Chapter 4: Communication Interfaces	21
4.1 Mini Slot.....	21
4.2 USB Port	21
4.3 RS-232 Port.....	21
4.4 Parallel Ports	22
4.5 External Battery Temperature Ports	22
4.6 Input Dry Contacts.....	23
4.7 REPO and Output Dry Contacts	25
4.7.1 REPO	25
4.7.2 Output Dry Contacts.....	26
Chapter 5: Installation and Wiring	28
5.1 Precautions Prior to Installation and Wiring	28
5.2 Installation Environment.....	28
5.3 UPS Transportation & Handling	29
5.4 UPS Installation.....	29
5.5 Wiring	32

5.5.1	Precautions Prior to Wiring	32
5.5.2	Single Input/ Dual Input Modification	35
5.5.3	Single Unit Wiring.....	36
5.5.4	Parallel Units Wiring.....	39
5.6	External Battery Cabinet Connection Precautions	42
Chapter 6: UPS Operation.....		47
6.1	Pre Start-up & Pre Turn-off Warnings for Single Unit and Parallel Units	47
6.2	Start-up Procedures	48
6.2.1	Online Mode Start-up Procedures	48
6.2.2	Battery Mode Start-up Procedures	50
6.2.3	Bypass Mode Start-up Procedures	51
6.2.4	Manual Bypass Mode Start-up Procedures	53
6.2.5	ECO Mode Start-up Procedures	57
6.2.6	Frequency Conversion Mode Start-up Procedures	60
6.2.7	Energy Recycle Mode Start-up Procedures	63
6.3	Turn-off Procedures.....	65
6.3.1	Online Mode Turn-off Procedures.....	65
6.3.2	Battery Mode Turn-off Procedures.....	67
6.3.3	Bypass Mode Turn-off Procedures	69
6.3.4	Manual Bypass Mode Turn-off Procedures.....	70
6.3.5	ECO Mode Turn-off Procedures	71
6.3.6	Frequency Conversion Mode Turn-off Procedures.....	73
6.3.7	Energy Recycle Mode Turn-off Procedures	76
Chapter 7: Touch Panel Display and Settings		79
7.1	Touch Panel Display Hierarchy	79
7.2	Turn on the touch panel	82
7.3	ON/ OFF Button	83
7.4	Introduction of Touch Panel and Function Keys.....	84
7.5	Password Entry	88
7.6	Main Screen	88
7.7	Power Flow & Summary.....	92
7.8	Measurement	94
7.8.1	Main Input	95

7.8.2	Bypass Input	95
7.8.3	Inverter Output	96
7.8.4	UPS Output	96
7.8.5	Battery Status.....	97
7.9	Setup	98
7.9.1	Bypass Setting	98
7.9.2	Mode Setting	100
7.9.3	Output Setting	101
7.9.4	Battery and Charging Setting.....	103
7.9.5	Parallel Setting	108
7.9.6	Dry Contact Setting	109
7.9.7	General Setting	111
7.9.8	Control.....	116
7.10	Maintenance.....	117
7.10.1	Warning	118
7.10.2	Historical Event	118
7.10.3	Statistics.....	119
7.10.4	Test.....	120
7.10.5	Clear.....	120
7.10.6	Advanced Diagnosis	121
7.10.7	Version & S/N.....	122
Chapter 8: Optional Accessories		123
Chapter 9: Maintenance		124
Appendix 1: Technical Specifications		126
Appendix 2: Warranty		128

Chapter 1: Important Safety Instructions

1.1 Installation Warnings

- This is a three-phase four-wire on-line uninterruptible power supply (hereafter referred to as 'UPS'). It can be used for commercial and industrial applications.
- Before installation, do not unpack the package of the UPS. Install the UPS in a well-ventilated indoor area, away from excess moisture, heat, dust, flammable gas or explosives.
- Leave adequate space around all sides of the UPS for proper ventilation and maintenance. Please refer to **5.2 Installation Environment**.
- Only authorized Delta engineers or service personnel can perform installation and maintenance. If you want to install the UPS by yourself, please install it under the supervision of authorized Delta engineers or service personnel.
- Follow the IEC 60364-4-42 standard to install the UPS.

1.2 Connection Warnings

- The UPS must be well grounded due to a possible risk of current leakage.
- It is necessary to install protective devices when the UPS is connected to the mains and bypass source. For relevant information, please refer to **5.5.1 Precautions Prior to Wiring**.
- The protective devices connecting to the UPS must be installed near the UPS and must be easily accessible for operation.

1.3 Usage Warnings

- Only qualified service personnel can upgrade the UPS's firmware.
- This is a class-A product. In a domestic environment, this product may cause radio interference, in which case, the user is required to take adequate measures.
- The UPS can be used to power computers and associated peripheral devices, such as monitors, modems, cartridge tape drives, external hard drives, etc.
- If the UPS needs to be connected to a motor load, it must be confirmed by qualified service personnel.
- It is strictly forbidden to connect the UPS with any regenerative-type loads.
- The parallel UPSs can connect with common batteries.

- The external slits and openings in the UPS are provided for ventilation. To ensure reliable operation of the UPS and to protect the UPS from overheating, these slits and openings must not be blocked or covered. Do not insert any object into the slits and openings that may hinder ventilation.
- In a low temperature environment (below 0°C), you must allow the UPS to adjust to room temperature for at least one hour to avoid moisture condensing inside the UPS before usage.
- The length of the communication cable must be less than 10 meters.
- Do not put beverage containers on the UPS, battery cabinet or any other accessory associated with the UPS.
- The risk of dangerous high voltage is possible when the batteries are still connected to the UPS even though the UPS is disconnected from the mains. Do not forget to pull out the battery cable to completely cut off the battery source.
- Do not open or mutilate the battery or batteries. The released electrolyte is harmful to the skin and eyes and may be toxic.
- The parameter setting of the number of batteries must be consistent with the actual number of batteries installed, otherwise the battery will be overcharged or under-charged, and the battery may be damaged.
- Do not dispose of the battery or batteries in a fire. The batteries may explode.
- All maintenance services must be performed by qualified service personnel. Forbid opening or removing the cover of the UPS to avoid high voltage electric shock.
- You must contact qualified service personnel if either of the following events occurs:
 1. Liquid is poured or splashed on the UPS.
 2. The UPS does not run normally after this **User Manual** is carefully observed.



NOTE:

If you use the UPS in an area that generates or incurs dust, you should install dust filters (optional) in the UPS to ensure normal product life and functions.

1.4 Storage Warnings

- **Prior to installation**

If the UPS needs to be stored prior to installation, it should be placed in a dry area. The allowable storage temperature is between -25°C and +70°C. (Not including batteries)

- **After usage**

Make sure the UPS is shutdown, disconnect the UPS from the main AC power, remove all equipment from the UPS, and store the UPS in a dry and well-ventilated area. Idle batteries must be recharged fully approximately every three months if the UPS needs to be stored for an extended period of time. The charging time must not be less than 24 hours each time.

1.5 Standard Compliance

- IEC62040-1
- IEC62040-2 C2
- IEC61000-4-2 (ESD) Level 4
- IEC61000-4-3 (Radiated Field) Level 3
- IEC61000-4-4 (EFT) Level 4
- IEC61000-4-5 (Surge) Level 4

Chapter 2: Introduction

2.1 Product Introduction

The HPH series UPS provides three different rated power levels, 20kVA, 30kVA and 40kVA, for your selection, is a three-phase four-wire online uninterruptible power supply which provides reliable and stable sine-wave power to your electronic devices. The UPS applies the latest design of DSP digital control technology and highest quality assembly, with an output power factor up to unity. The efficiency of the entire device can reach up to 96% in online mode and up to 99% in ECO mode. With its outstanding features, the UPS not only provides safe, reliable and uninterrupted power to your sensitive electronic equipment at all times, but also produces greater electric power efficiency at less cost.

2.2 Package Inspection

- **External**

During UPS transportation, some unpredictable situations might occur. It is recommended that you inspect the UPS exterior packaging. If you notice any damage, please immediately contact the dealer from whom you purchased the unit.

- **Internal**

1. Check the rating label on the top of the UPS cabinet and make sure the device No. and capacity match what you ordered.
2. Examine if any parts are loose or damaged.
3. The UPS package contains the following items. Please check if any items are missing.

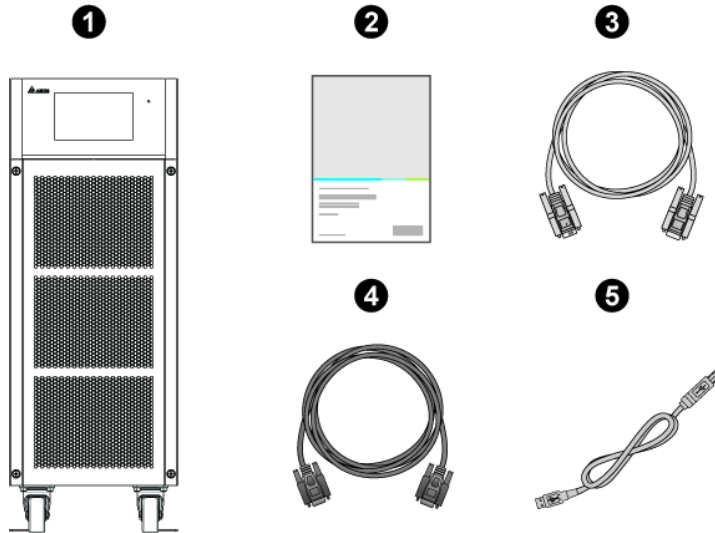

No.	Item	Qty
①	UPS	1 PC
②	User Manual	1 PC
③	RS232 Cable	1 PC
④	Parallel Cable	1 PC
⑤	USB Cable	1 PC



NOTE:

1. The balance supports have been fixed on the pallet at the factory, please save them properly for use during installation.
2. If there is any damage or anything missing, please immediately contact the dealer from whom you purchased the unit.
3. If the UPS needs to be returned, carefully repack the UPS and all of the accessories using the original packing material that came with the unit.

2.3 Functions and Features

The HPH series UPS is designed for systems with medium power. It provides clean power supply to data systems, communication systems, computer network systems, medical treatment systems, monitoring systems, factory equipment, etc.

- The HPH series UPS utilizes all digital high frequency modulation technology, which decreases volume, improves reliability and prolongs service life. Wide AC input voltage range

(100% load: 176~276/ 305~478Vac; 70%~100% load: 132~276/ 228~478Vac) reduces frequent transfer from normal mode to battery mode to save battery consumption and prolong battery life.

- Battery test in online mode and regular battery test prolong battery life.
- Automatic input frequency detection enables operation at 50Hz or 60Hz.
- You can parallel at maximum four UPS units for N+X parallel redundancy, capacity expansion and reliability enhancement.
- It is convenient to set the parameters and view operating conditions on the colorful touch panel, so that management personnel can see them accurately and clearly.
- It can set the output voltage on touch panel as: 220/ 230/ 240Vac.
- The CPU can record up to 10000 entries of abnormal information of the UPS, which is helpful in fault diagnosis for the UPS and in the improvement of the maintenance efficiency.
- No-battery start-up: In case the external battery cabinet is not connected, the device can still start up normally with normal main AC power.
- REPO port: Under emergency status, use a user-supplied remote control switch to disconnect the output immediately to prevent any danger.
- Built-in RS232 port allows monitoring and management of the UPS via the UPSentry 2012 software (<https://datacenter-softwarecenter.deltaww.com>).
- Attaches optional accessories like Mini SNMP card for network communication.
- Other optional accessories include Mini Relay I/O and Mini MODBUS cards for dry contact, and MODBUS communication.
- In order to improve the efficiency further, the UPS can be set to operate in ECO mode. In case of any abnormal conditions, the UPS will transfer to online mode automatically.
- Automatically detects and shows whether fans are operating normally.
- The fans have automatic speed regulation function. With multi-stage control over the fan speed, it can improve the reliability and the efficiency of the system, reduce the noise and prolong the service life of the fans. What's more, the UPS has the function of fan failure detection
- Provides equalized charge and float charge. You can adjust the charge current from 1A to the maximum. Each adjustment level is 1A. The charging mode is set according to the actual charging current so as to keep the batteries at full charging capacity and prolong the battery life (float charge voltage: $\pm 272\text{Vdc}$; equalized charge voltage: $\pm 280\text{Vdc}$ (This is only for lead acid batteries)).

2.4 Appearance and Dimensions

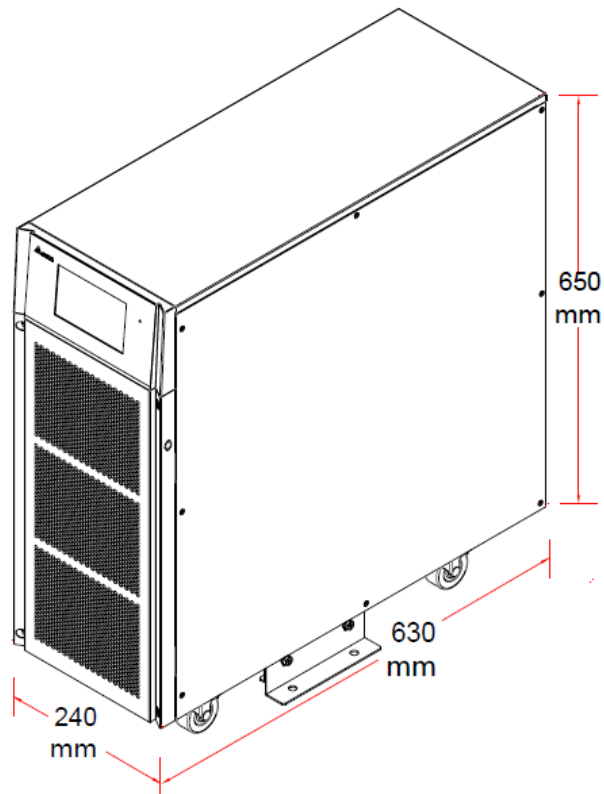

(Figure 2-1: 20/ 30/ 40kVA UPS Appearance and Dimensions)

2.5 Front Panel

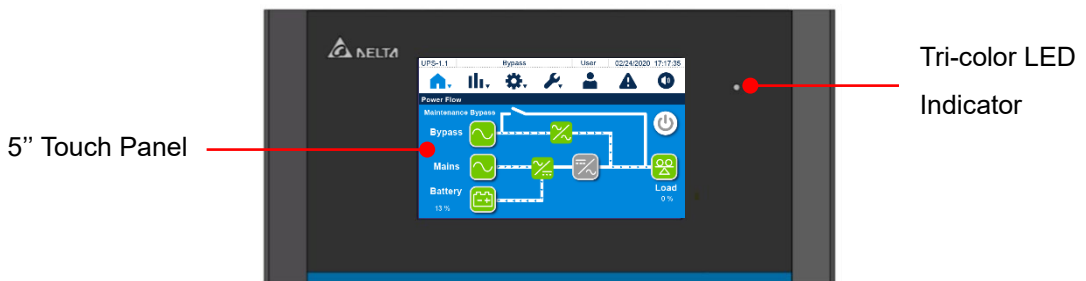

(Figure 2-2: Front Panel)

Please refer to the table below for the status of the tri-color LED indicator and buzzers.

Tri-color LED Indicator	Status	Meaning						
Green	ON	<ol style="list-style-type: none"> 1. The UPS is running in online mode and the text 'On-Line' appears at the top edge of the screen. 2. The UPS is running in ECO mode and the text 'ECO' appears at the top edge of the screen. 3. The UPS is running in frequency conversion mode and the text 'Frequency Conversion' appears at the top edge of the screen. 						
Yellow	ON	<ol style="list-style-type: none"> 1. The UPS is running in bypass mode and the text 'Bypass' appears at the top edge of the screen. 2. The UPS is running in battery mode and the text 'Battery' appears at the top edge of the screen. 3. The UPS is running in standby mode and the text 'Standby' appears at the top edge of the screen. 4. The UPS is in the soft start status and the text 'Softstart' appears at the top edge of the screen. 5. The UPS is in the energy recycle status and the text 'Energy Recycle' appears at the top edge of the screen. 6. There is a minor or medium warning and the buzzer sounds. <table border="1" data-bbox="522 1155 1108 1431"> <thead> <tr> <th>Warning Level</th> <th>Buzzer Frequency</th> </tr> </thead> <tbody> <tr> <td>Minor</td> <td>The buzzer beeps 0.1 second for every 2 seconds.</td> </tr> <tr> <td>Medium</td> <td>The buzzer beeps 0.1 second for every 0.5 second.</td> </tr> </tbody> </table> <p>To clear the warning, please contact Delta service personnel.</p>	Warning Level	Buzzer Frequency	Minor	The buzzer beeps 0.1 second for every 2 seconds.	Medium	The buzzer beeps 0.1 second for every 0.5 second.
Warning Level	Buzzer Frequency							
Minor	The buzzer beeps 0.1 second for every 2 seconds.							
Medium	The buzzer beeps 0.1 second for every 0.5 second.							
Red	ON	<p>There is a major warning and the buzzer sounds.</p> <table border="1" data-bbox="522 1534 1126 1630"> <thead> <tr> <th>Warning Level</th> <th>Buzzer Frequency</th> </tr> </thead> <tbody> <tr> <td>Major</td> <td>Long beep</td> </tr> </tbody> </table> <p>To clear the warning, please contact Delta service personnel.</p>	Warning Level	Buzzer Frequency	Major	Long beep		
Warning Level	Buzzer Frequency							
Major	Long beep							

(Table 2-1: Tri-color LED Indicator & Buzzers)

2.6 Rear Panel

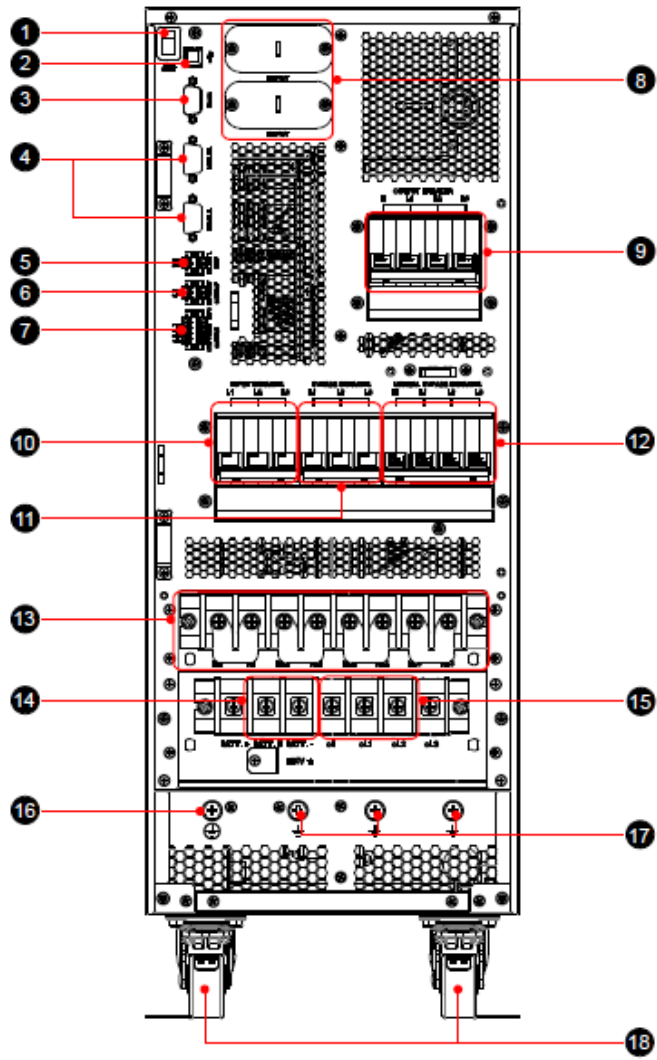

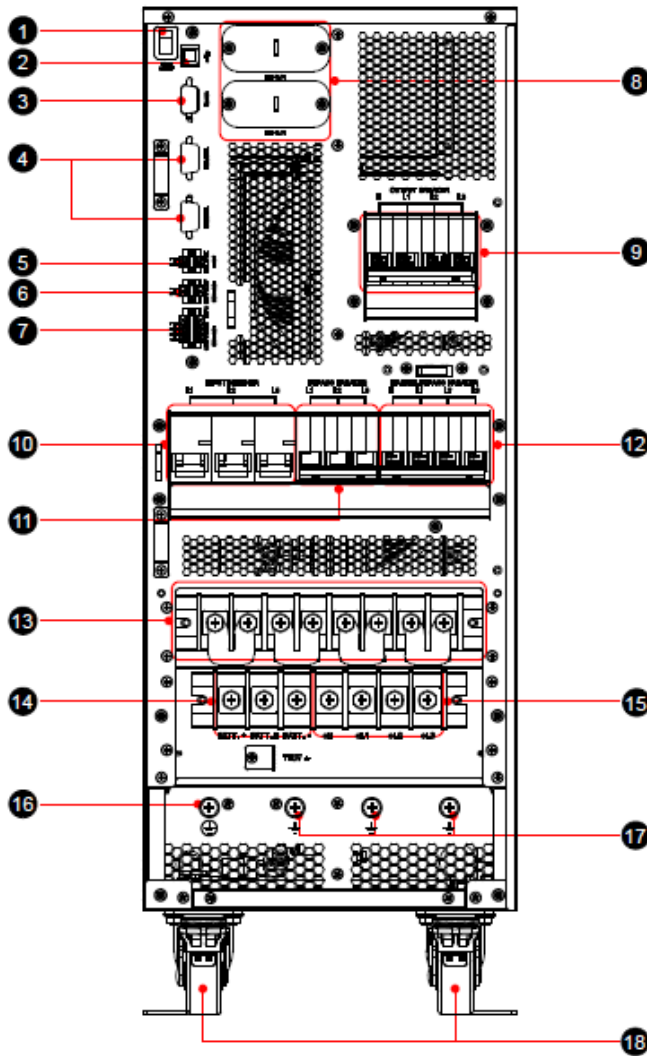

(Figure 2-3: 20kVA UPS Rear Panel)



(Figure 2-4: 30/ 40kVA UPS Rear Panel)

No.	Item	Description
1	Battery Start	When there are no AC mains, but the external battery cabinet is connected well with the UPS, the user can turn on the battery switch so that the UPS can work in battery mode.
2	 (USB Port)	Connects to a computer. For detailed information, please refer to Chapter 4: Communication Interfaces .
3	RS-232 Port	Connects to a computer. For detailed information, please refer to Chapter 4: Communication Interfaces .

No.	Item	Description
4	Parallel Ports	For UPS parallel usage. For detailed information, please refer to Chapter 4: Communication Interfaces .
5	External Battery Temp. Contacts	Detects the external battery cabinet's temperature.
6	Input Dry Contacts	Receive external information of devices connected to the input dry contacts. For detail information, please refer to Chapter 4: Communication Interfaces .
7	REPO Port	When an emergency event occurs, it can disconnect the UPS output power supply rapidly and shut down the UPS immediately. For detailed information, please refer to Chapter 4: Communication Interfaces .
	Output Dry Contacts	Receive the UPS's event information. For detail information, please refer to Chapter 4: Communication Interfaces .
8	MINI Slot	Connects Mini SNMP, Mini Relay I/O or Mini MODBUS card. For detailed information, please refer to Chapter 4: Communication Interfaces .
9	Output Breaker	Connects or disconnects the UPS's loads and for safety protection.
10	Input Breaker	Connects or disconnects the UPS's main input power and for safety protection.
11	Bypass Input Breaker	Connects or disconnects the UPS's bypass power and for safety protection.
12	Manual Bypass Breaker	For maintenance only! Only authorized service personnel can open the cover plate of the manual bypass switch and operate it. Please note that opening this cover plate in online mode will cause inverter shutdown.
13	AC Input Terminal Block	Connects the main AC source.
14	Battery Input Terminal Block	Connects the external battery cabinet.
15	UPS Output Terminal Block	Connects the critical loads.

No.	Item	Description
16		For the UPS system grounding.
17		For external battery cabinet's grounding. For critical load grounding. For bypass grounding.
18	Casters	<p>The casters are designed for a short distance movement only. Do not use the casters to move the UPS over a long distance.</p> <p>The casters are not designed to provide long-term support for the UPS after installation, please use the balance supports to support the UPS.</p>

Chapter 3: Operation Modes

- **Online Mode**

The critical load is supplied by the inverter, which derives its power from the main AC power, and the UPS charges the batteries as needed and provides power protection to the equipment. During on-line mode, the LED indicator illuminates green.

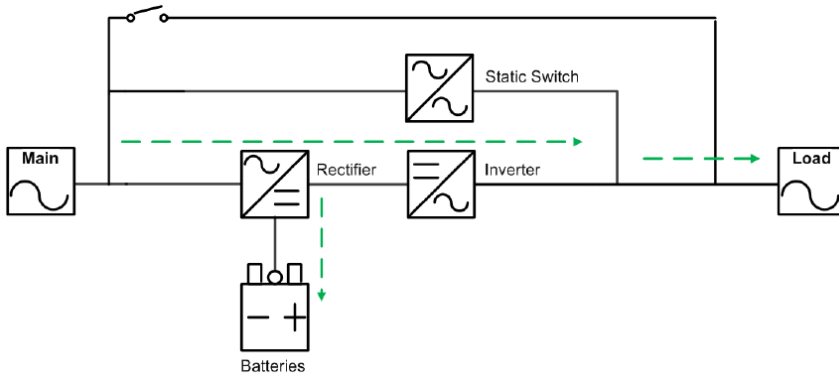

(Figure 3-1: Path of Electrical Power through the UPS in Online Mode)

- **Standby Mode**

When the input voltage and frequency of the main AC power are within the normal range, the UPS runs in standby mode and charges the batteries. The bypass and the inverter have no output. The LED indicator illuminates yellow.

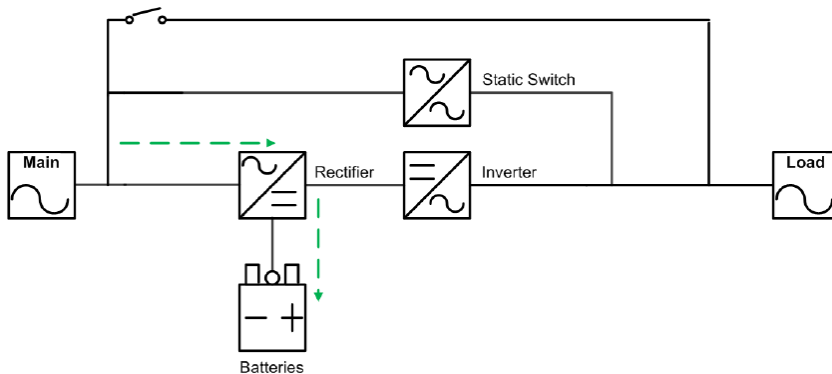

(Figure 3-2: Path of Electrical Power through the UPS in Standby Mode)

- **ECO Mode**

You can manually set the UPS to ECO mode. In ECO mode, when the utility input voltage is within the range of rated voltage (default: $\pm 10\%$), the load is supplied by the main AC power and the LED indicator illuminates green; if out of the range, the load is supplied by the inverter and the LED indicator illuminates yellow.

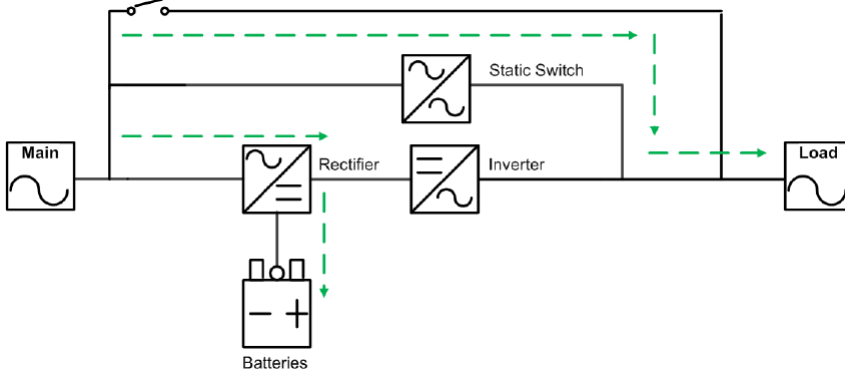

(Figure 3-3: Path of Electrical Power through the UPS in ECO Mode)

- **Battery Mode**

When the input voltage or frequency of the UPS is out of working range, the batteries provide DC power, which maintains inverter operation to support the critical load. During battery mode, the LED indicator illuminates yellow.

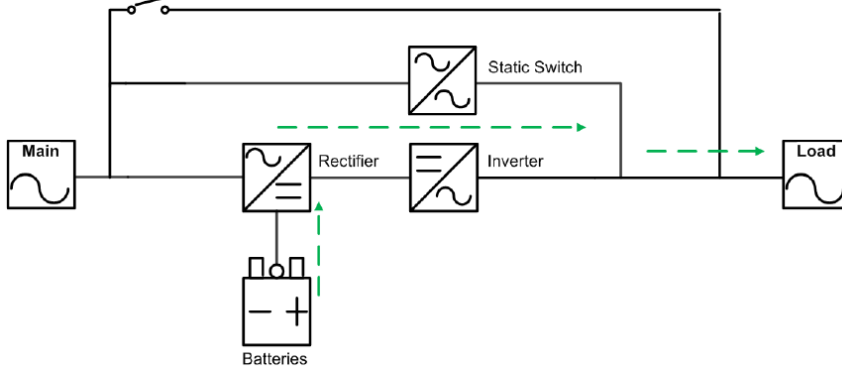

(Figure 3-4: Path of Electrical Power through the UPS in Battery Mode)

The battery status is as follows:

Battery Capacity	Buzzer	TOUCH PANEL Display
Full/ Mid	The alarm beeps once every 2 seconds. (ON for 0.1 second and OFF for 1.9 seconds)	XX mins/ XXX% Battery Icon: gray-green flashing
Low	The alarm beeps once every 0.5 second. (ON for 0.1 second and OFF for 0.4 second)	XX mins/ XXX% Battery Icon: gray-green flashing
Under	Long beep	0% Battery Icon: gray-red flashing

- **Bypass Mode**

The critical load is directly supplied by the main AC power and the batteries are charged. During bypass mode, the LED indicator illuminates yellow.

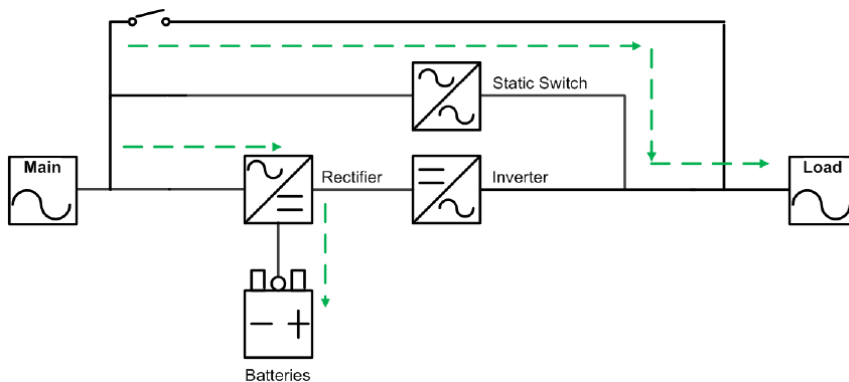

(Figure 3-5: Path of Electrical Power through the UPS in Bypass Mode)

- **Frequency Conversion Mode**

When the UPS is manually set in frequency conversion mode, the output frequency can be set as 50Hz or 60Hz. After the output frequency is set up, the system will automatically disable the bypass function. Please note that once the inverter shuts down, there is no bypass output. During converter mode, the LED indicator illuminates green.

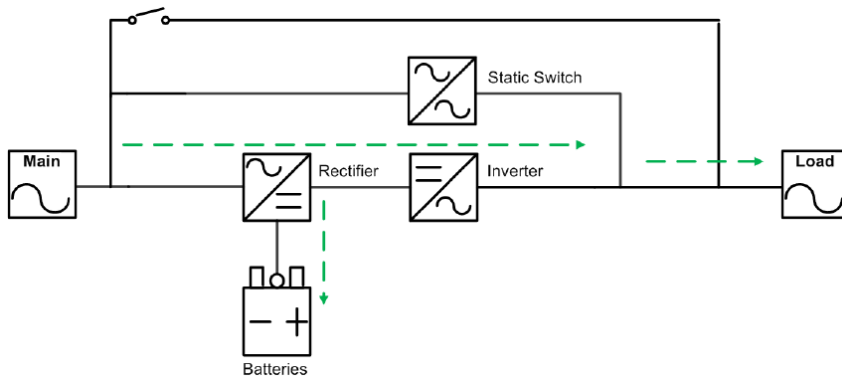

(Figure 3-6: Path of Electrical Power through the UPS in Frequency Conversion Mode)

- **Energy Recycle Mode**

When the UPS is manually set in energy recycle mode, the charger will turn off, and the output power will be recycled to input. Energy recycle mode is applicable to UPS self-loading test only. During energy recycle mode, the LED indicator illuminates green.

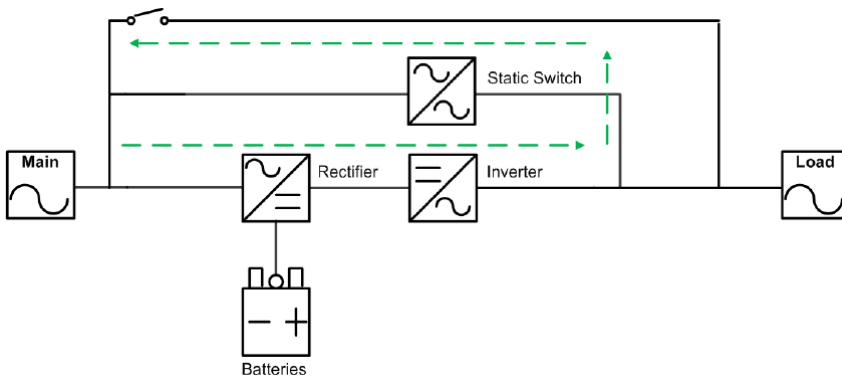

(Figure 3-7: Path of Electrical Power through the UPS in Energy Recycle Mode)



NOTE:

In energy recycle mode, please make sure that the output breaker is in the **OFF** position.

Chapter 4: Communication Interfaces



NOTE:

1. The UPS can still function properly without making the connections below.
2. USB port and RS-232 port cannot be used at the same time.
3. The length of the communication cable must be less than 10 meters.
4. For the location of the communication interfaces, please refer to **Figure 2-3~2-4**.

4.1 Mini Slot

The Mini slot is for installation of a mini card. You can install a Delta Mini SNMP, Mini Relay I/O or Mini MODBUS card in this slot to let the system have network communication, dry contact function, or MODBUS communication. For installation information of Mini cards, please contact Delta service personnel.

4.2 USB Port

USB port is located on the rear panel of the UPS. Please use the provided USB cable to connect the UPS with a computer and install the UPSentry 2012 software*1 to check and monitor the UPS status.



NOTE:

1. *1 You can download the software from the following link:
<https://datacenter-softwarecenter.deltaww.com>
2. Do not use the USB port and RS-232 port at the same time.

4.3 RS-232 Port

The RS-232 port has the same functions with USB port mentioned above. Detailed information is as follows:

1. RS-232 communication (Baud Rate: 2400bps)
2. UPS setting

3. Pin Assignment:

- 1) PIN 2: TXD <Transmitting Data>
- 2) PIN 3: RXD <Receiving Data>
- 3) PIN 5: GND <Signal Ground>

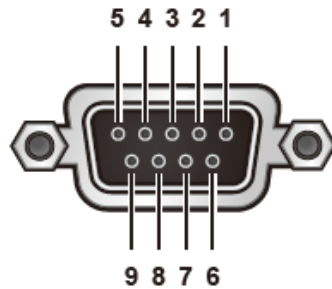

(Figure 4-1: RS-232 Port)

4.4 Parallel Ports

The two parallel ports are for UPS parallel communication. UPSs (at maximum four) with the same capacity, voltage and frequency can be coupled via the provided parallel cable to run in parallel mode. To enhance parallel reliability, please adopt Daisy Chain method (see **Figure 5-10** & **Figure 5-11**) to execute parallel configuration.

4.5 External Battery Temperature Ports

A. The external battery temperature ports are used for detecting the connected external battery cabinet's temperature. You need to purchase the optional external battery cabinet temperature detection cable to do that. Please **NOTE** that this function is realized by Port 1, and Port 2 is reserved.

B. You can also purchase the Mini SNMP card (IPv6) and the EnviroProbe 1000 to detect the external battery cabinet's temperature.

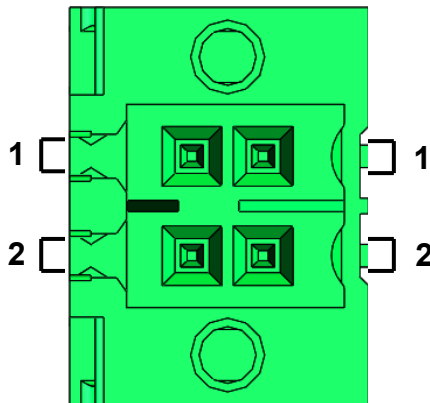

(Figure 4-2: External Battery Temperature Port)

4.6 Input Dry Contacts

The HPH UPS provides two sets of input dry contacts and they are normally open. There are ten events for you to select, and you can choose two of them to set up the input dry contacts. Please refer to the table below.

No.	Event	Description
0	None	No Setting.
1	UPS ON/OFF	To control UPS startup or shutdown.
2	AC Generator Connect	To detect the status of the generator.
3	Battery Ground Fail	To detect the leakage current of battery.
4	External Battery Breaker Detection	To detect the breaker status of external battery cabinet.
5	Charge Off (Positive)	- When li-ion battery BMS sent a signal (NC /NO, adjustable) to UPS, UPS would stop charging to battery positive. * When user only have single output dry contact event, user could parallel the dry contacts of Charge off (positive) & Charge (negative).
6	Charge Off (Negative)	- When li-ion battery BMS sent a signal (NC /NO, adjustable) to UPS, UPS would stop charging to battery negative.
7	External Manual Bypass Detection	To detect the status of the external manual bypass switch/breaker.
8	Active Standby	UPS would turn off its inverter and wait for the Synchronization with other paralleled UPSs, then transfer to manual bypass.
9	Li-ion Battery Over Discharge Warning	Receive the over discharge signal of li-ion battery power management system.

(Table 4-1: Input Dry Contact Events and Description)

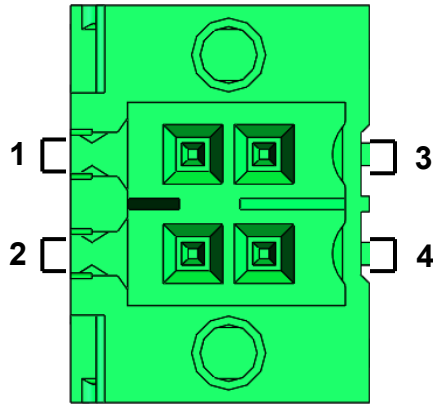

(Figure 4-3: Input Dry Contacts)

There are two types of input dry contact configurations.

- **Figure 4-4** shows the 1st type of configuration. It requires internal power, +12VSF.

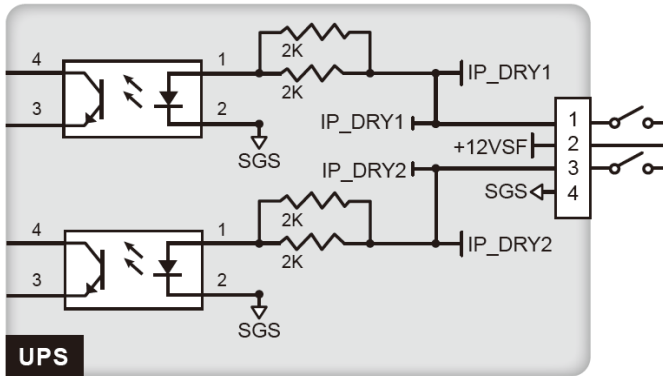

(Figure 4-4: Input Dry Contact Configuration I)

- **Figure 4-5** shows the 2nd type of configuration. It requires external power with a voltage range between 6~12Vdc.

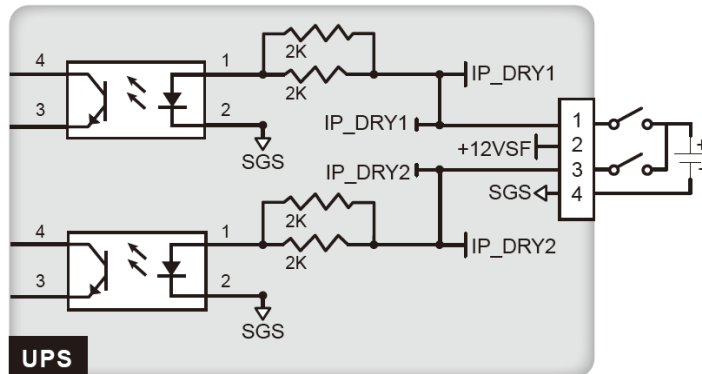

(Figure 4-5: Input Dry Contact Configuration II)

4.7 REPO and Output Dry Contacts

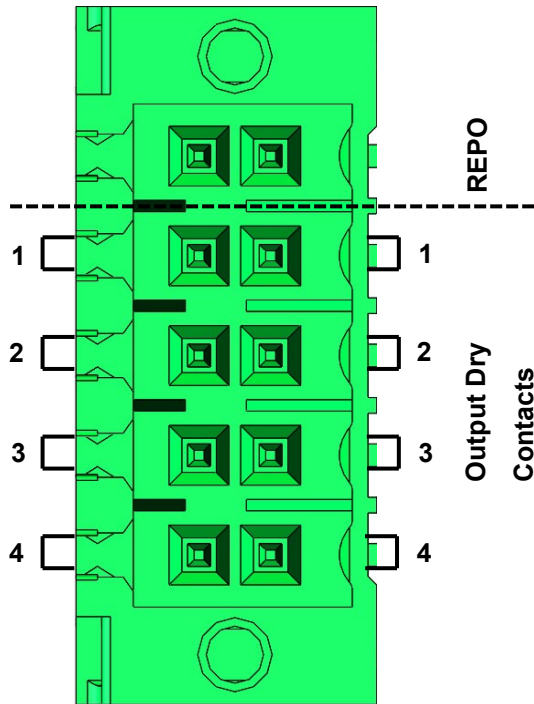

(Figure 4-6: REPO & Output Dry Contacts)

4.7.1 REPO

The REPO dry contacts provide you with quick and convenient interfaces to stop the UPS output power when an emergency occurs. Connect the REPO dry contacts to a user-supplied switch and you can remotely stop the UPS output power. The configuration is shown as follows.

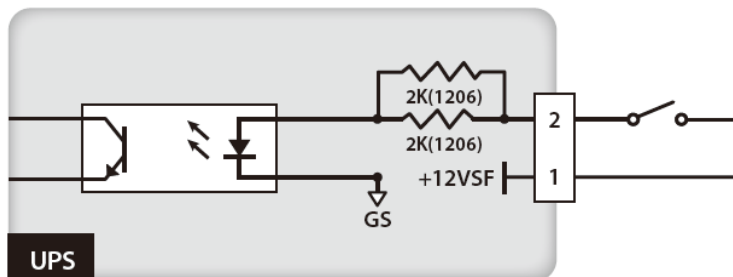

(Figure 4-7: REPO Port Configuration)



NOTE:

If you need more information about REPO setting, please contact your dealer or Delta service personnel. Only qualified Delta engineer or service personnel can modify the REPO setting.

4.7.2 Output Dry Contacts

The HPH UPS provides four sets of programmable output dry contacts for you to receive UPS events. Please see **Figure 4-8**. The output dry contacts are normally open. There are eighteen events for you to select, and you can choose four of them to set up the output dry contacts. Please refer to the table below.

No.	Event	Description
1	Summary Alarm	When any UPS alarm occurs, the UPS will send an signal.
2	Load On Inverter	The UPS works in online mode.
3	Load On Bypass	The UPS works in bypass mode.
4	Load On Battery	When AC mains is abnormal, the UPS transfers and runs in Battery mode.
5	Battery Low	When the UPS runs in battery mode, battery voltage is lower than setup limit (220Vdc; default).
6	Bypass Input Abnormal	The bypass voltage, frequency or phase sequence is abnormal.
7	Battery Test Fail	In the process of battery test, battery voltage is out of setup limit.
8	Parallel Communication Fail	In parallel mode, parallel communication is abnormal.
9	Output Overload	When the UPS is overloaded or UPS shutdown, the UPS transfers and runs in bypass mode.
10	EPO Activated	The EPO button is pressed to urgently power off the UPS.
11	Load On Manual Bypass	The Manual Bypass Breaker is switched on and the UPS transfers to manual bypass mode.
12	Battery Over Temperature	The external battery cabinet's temperature is too high.
13	Output Voltage Abnormal	The output voltage is out of range.
14	Battery Need Replacement	Battery replacement date is due.
15	Bypass Static Switch Fault	The bypass static switch has open/ short issue.

No.	Event	Description
16	UPS Over Temperature	When the UPS temperature is out of range.
17	Battery Breaker Shunt Trip	When the EPO button is pressed, the UPS will send a signal to the connected external shunt trip device to cut off the battery power.
18	Backfeed Protection	When the UPS's bypass SCR has an open/ short issue, the UPS will send a signal to the connected external shunt trip device to cut off the backfeed voltage.

(Table 4-2: Output Dry Contact Events and Description)

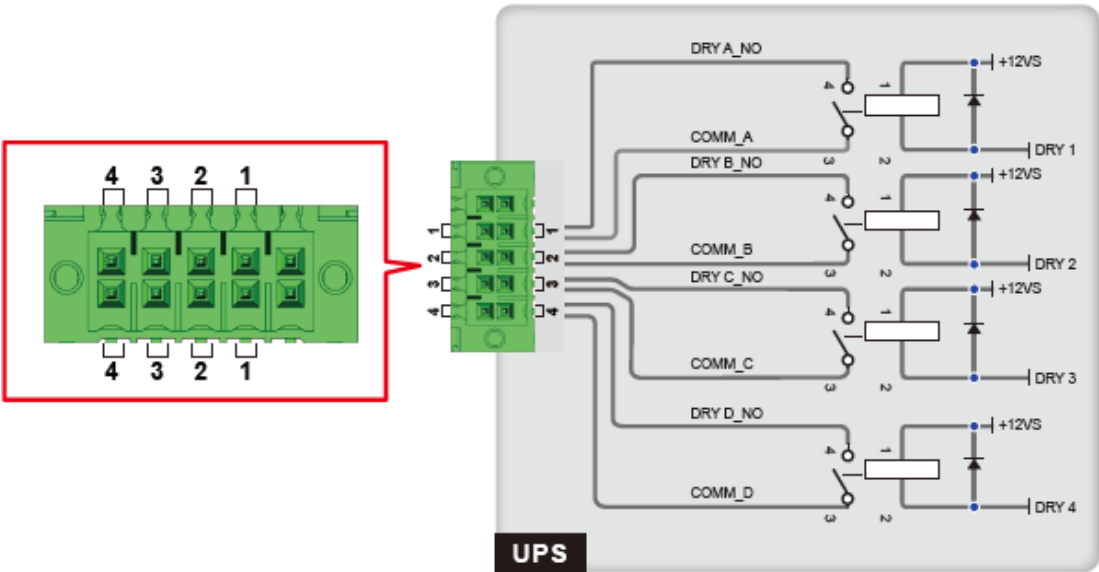

(Figure 4-8: Output Dry Contacts: Port Definition and Design)

Chapter 5: Installation and Wiring

5.1 Precautions Prior to Installation and Wiring

Due to different installation environments, it is highly recommended that you read this user manual before installation. Only authorized Delta engineers or service personnel can perform installation and maintenance. If you want to install the UPS by yourself, installation must be under the supervision of authorized Delta engineers or service personnel. If you use a forklift or other equipment to move the UPS, please make sure its load bearing is sufficient. For the weight of the UPS, please refer to **Appendix 1: Technical Specifications**.

5.2 Installation Environment

- Install the UPS indoors. Do not place it outdoors.
- Make sure that transportation routes (e.g. corridor, door gate, elevator, etc.) and installation area can accommodate the UPS, other equipment and forklifts. And make sure that transportation routes and installation area can bear the weight of the UPS, other equipment and forklifts. Make sure that transportation routes (e.g. corridor, door gate, elevator, etc.) and installation area can accommodate and bear the weight of the UPS, external battery cabinets, other equipment that will be installed nearby and forklifts. For the weight of the UPS, please refer to **Appendix 1: Technical Specifications**.
- The installation place must be kept clean and tidy at all times.
- Ensure that the installation area is large enough for maintenance and ventilation. Since the UPS adopts the design of air inlet at the front and air outlet at the rear, it is recommended that you place the external battery cabinet next to the UPS. we suggest that you:
 1. Keep a distance of 100cm from the front of the UPS for maintenance and ventilation.
 2. Keep a distance of 50cm from the back of the UPS for maintenance and ventilation.
 3. Keep a distance of 50cm from the both sides of the UPS for maintenance.
- Keep the installation area's temperature around 0°C~40°C and humidity under 95% non-condensing. The normal operating altitude is under 1000 meters above sea level.



WARNING:

Do not use air conditioners or similar equipment to blow into the rear side of the UPS and hinder ventilation.

5.3 UPS Transportation & Handling

There are four casters at the bottom of the UPS. Please pay attention to the movement of the casters to avoid accidents when you remove the UPS from its pallet. The casters are designed to move on level ground. Do not move the UPS on an uneven surface. This might cause damage to the casters or tip the UPS which could damage the unit. If you need to move the UPS over a long distance, please use appropriate equipment like a forklift. Do not use the UPS casters to move the unit over a long distance.

5.4 UPS Installation

There are two installation methods. One is with the balance supports, and the other is without the balance supports.

- **Installation without the Balance Supports**

After moving the UPS to its final installation area, press the brakes of the casters to stabilize the UPS cabinet on the ground.

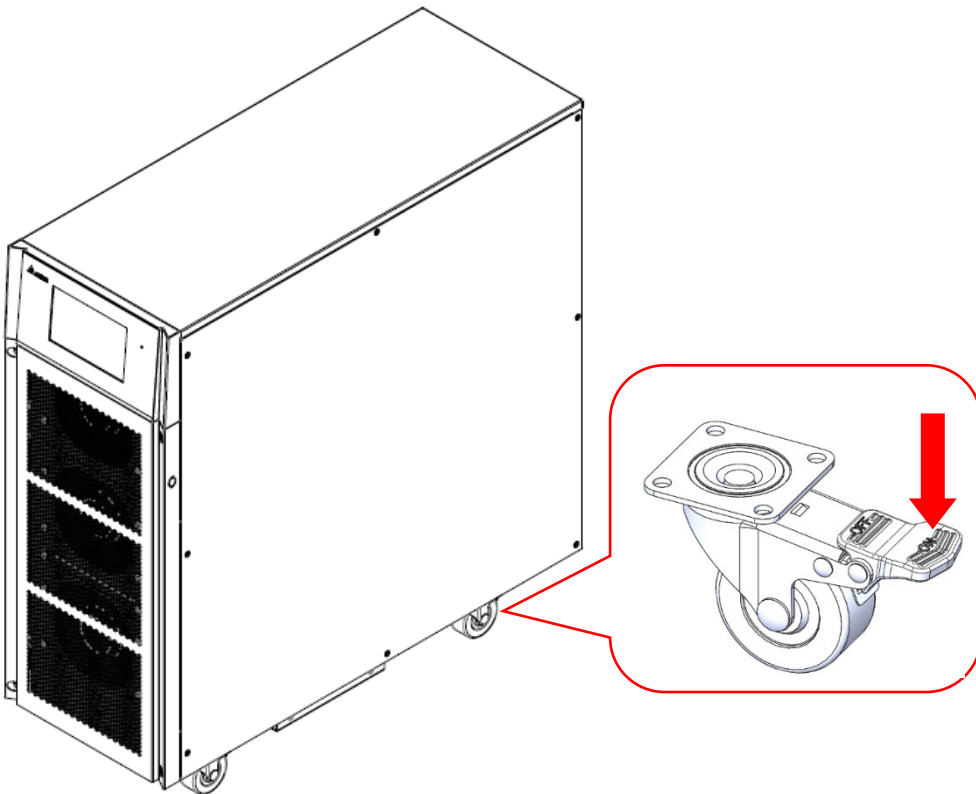

(Figure 5-1: Stabilize the UPS with the Brakes of the Casters)



NOTE:

If you need to move the UPS, raise the brakes of the casters first.

● **Installation with the Balance Supports**

If you want to install the UPS with the balance supports that have been removed from the UPS during the unpacking process, please follow the following steps.

1. After you decide the installation area, follow the mounting hole diagram below to drill holes on the installation ground.

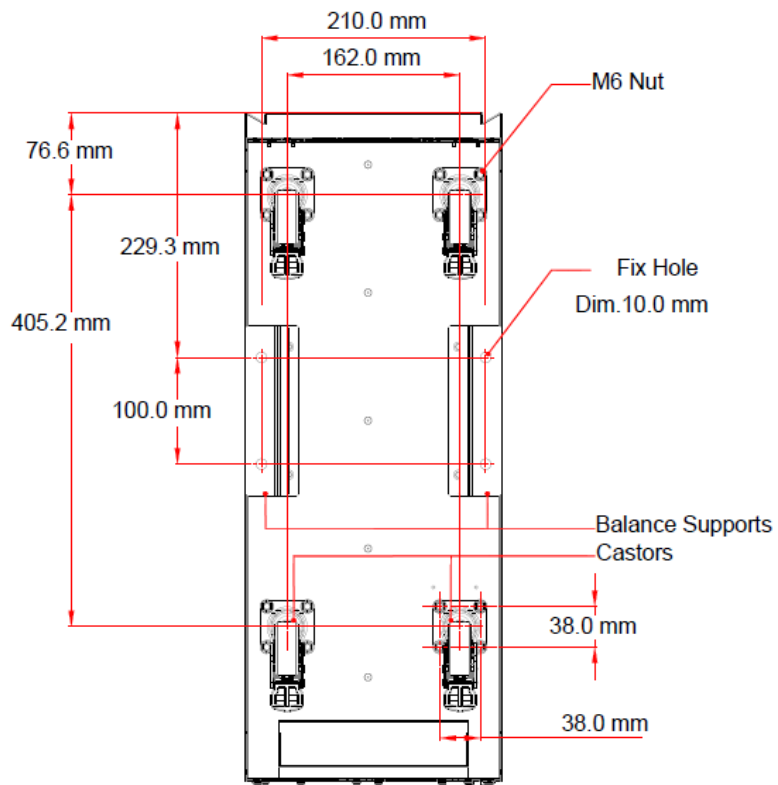

(Figure 5-2 : Mounting Hole Diagram)

2. Move the UPS on the installation ground that you have drilled holes, use the casters to stabilize the UPS on the ground and use the M6 screws to reinstall the balance supports (that have been removed from the UPS during the unpacking process) on the UPS. Please refer to the figure below.

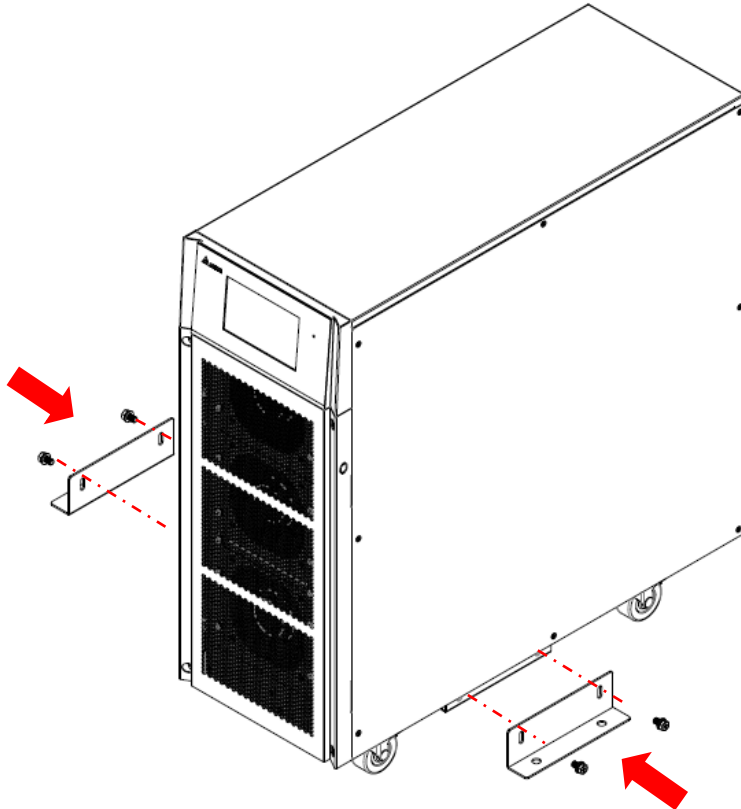

(Figure 5-3: Balance Support Installation)

3. Use four M8 expansion screws to fix the balance supports on the ground to avoid UPS movement. Please note that service personnel should provide the expansion screws. Please refer to the figure below.

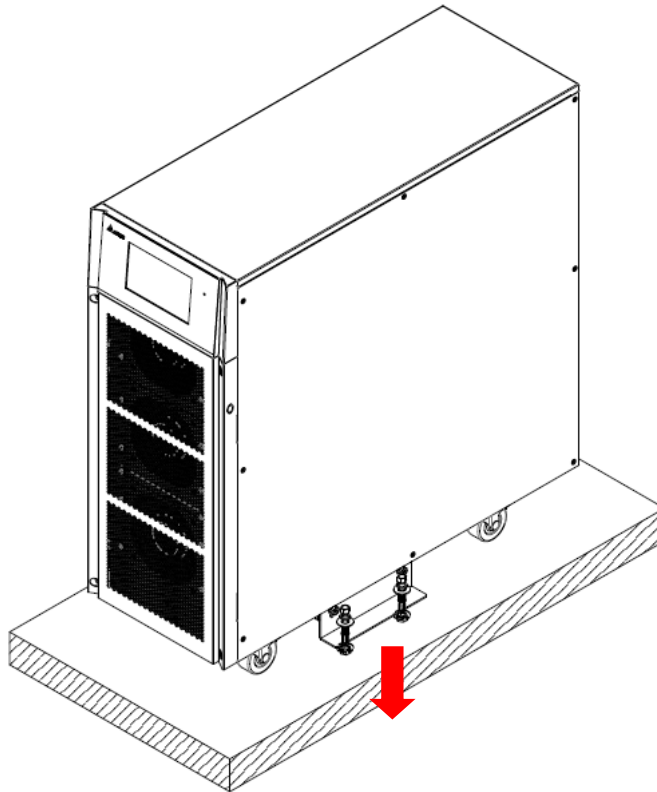

(Figure 5-4: Fix the Balance Supports on the Ground)

5.5 Wiring

5.5.1 Precautions Prior to Wiring

- The wiring must be performed by qualified professional personnel. If you want to install the UPS by yourself, installation must be under the supervision of Delta service personnel.
- Before wiring or making any electrical connection, make sure the power supplied to the input and output of the UPS is completely cut off.
- When connecting the UPS to the main AC power, you must install a protective device that meet safety certifications; please refer to the table below. For installation of the protective device, please refer to **Figure 5-8~5-9**.

**NOTE:**

Regarding **Figure 5-8~5-9**, each figure represents that the main AC power is the TN system and a 3-pole backfeed protective device is installed between the UPS and the main AC power. If your main AC power is the TT system, please install a 4-pole backfeed protective device between the UPS and the main AC power.

UPS	Suggested Protective Device	Suggested Supplier
20kVA	D-Curve 50A circuit breaker	Input & Bypass: CHNT (CB-60-D50)
30/ 40kVA	D-Curve 100A circuit breaker	Input: CHNT (CB-125-D100) Bypass: CHNT (CB-60-D63)

- When connecting the UPS to the critical loads, you must install a 3-pole EN 60947-2 certified breaker between them. Please refer to the table below.

UPS	Suggested Protective Device	Suggested Supplier
20kVA	C-Curve 40A Breaker	Output: CHNT (CB-60-C40)
30/ 40kVA	C-Curve 63A Breaker	Output: CHNT (CB-60-C63)

- Check that the size, phase and polarity of each cable that needs connecting to the UPS is correct. For the specifications of input/ output cables and terminal block, please refer to **Table 5-1**.

Table 5-1: Specifications of Input/ Output Cables and the UPS's Breakers

Capacity (kVA)	20kVA	30kVA	40kVA
AC Input cable	6AWG/ 10mm ²	2AWG/ 25mm ²	2AWG/ 25mm ²
Output cable	6AWG/ 10mm ²	4AWG/ 16mm ²	4AWG/ 16mm ²
Battery Input cable	6AWG/ 10mm ²	2AWG/ 25mm ²	2AWG/ 25mm ²
Tightening Torque	33 kgf-cm/ 29 lb-in	33 kgf-cm/ 29 lb-in	33 kgf-cm/ 29 lb-in
Input Breaker	50A (3-pole×1)	100A (3-pole×1)	100A (3-pole×1)
Bypass Input Breaker	50A (3-pole×1)	63A (3-pole×1)	63A (3-pole×1)
Max Cable Lug Width	17mm (0.67")	17mm (0.67")	17mm (0.67")
Screw Size/ Cable Lug Inner Diameter	M6/ 6.4mm (0.25")	M6/ 6.4mm (0.25")	M6/ 6.4mm (0.25")



NOTE:

1. In accordance with **National Electrical Codes (NEC)**, please install a suitable conduit and bushing.
 2. Please refer to national and local electrical codes for acceptable protective device and cable size.
 3. Cables with PVC material and with temperature resistance up to 105°C are suggested.
 4. Make sure that the input/ output cables are locked tightly.
-
- When connecting with the external battery cabinet, please confirm the polarity. Do not reverse the polarity.
 - Connect the external battery cabinet's grounding terminal to the grounding terminal ($\frac{\perp}{\ominus}$) of the UPS (as for the location of the terminal, please refer to **Figure 5-8**). Do not connect the grounding terminal of the external battery cabinet to any other grounding system.
 - The UPS default setting is single input. If there is an intention to change the UPS into dual input or hot standby redundancy configuration, please contact Delta service personnel. Please check whether the electric potential of the neutral line (bN) of the bypass source is the same as that of the neutral line (mN) of the main AC source. If they do not share a common neutral line system, add an isolation transformer to the bypass source.
 - The input of the UPS must be a Y connection, and the neutral line (mN/bN) must be connected to avoid UPS failure. Do not connect the neutral line (mN/bN) of the UPS with the ground terminal ($\frac{\perp}{\ominus}$).
 - If there is a floating voltage between the input power's neutral (mN/bN) and the ground ($\frac{\perp}{\ominus}$), and you require that the V_{NG} of the UPS should be zero, we suggest that you install an isolation transformer in front of the input side of the UPS, and connect the UPS neutral (mN/bN) with the ground ($\frac{\perp}{\ominus}$).
 - The main AC power must be three phases and meet the specifications specified on the UPS's rating label. When connecting the utility input power to the UPS, make sure three phases (mL1, mL2, mL3) are in positive phase sequence.
 - The ground terminal ($\frac{\perp}{\ominus}$) of the UPS must be grounded, and please use ring-type terminal for wiring.



WARNING:

1. Incorrect wiring will lead to severe electric shock and damage to the UPS.
2. The UPS will not work normally if the input powers neutral (mN/ bN/ BATT. N) is not firmly connected.

5.5.2 Single Input/ Dual Input Modification



WARNING:

1. Only authorized Delta engineers or service personnel can modify single input/ dual input setup.
2. For dual input, the main AC source's Neutral (mN) must be connected with the bypass source's Neutral (bN).

The UPS default setting is single input. If you want to modify it into dual input, please follow the following steps.

1. Remove the panels shown in the figure below.

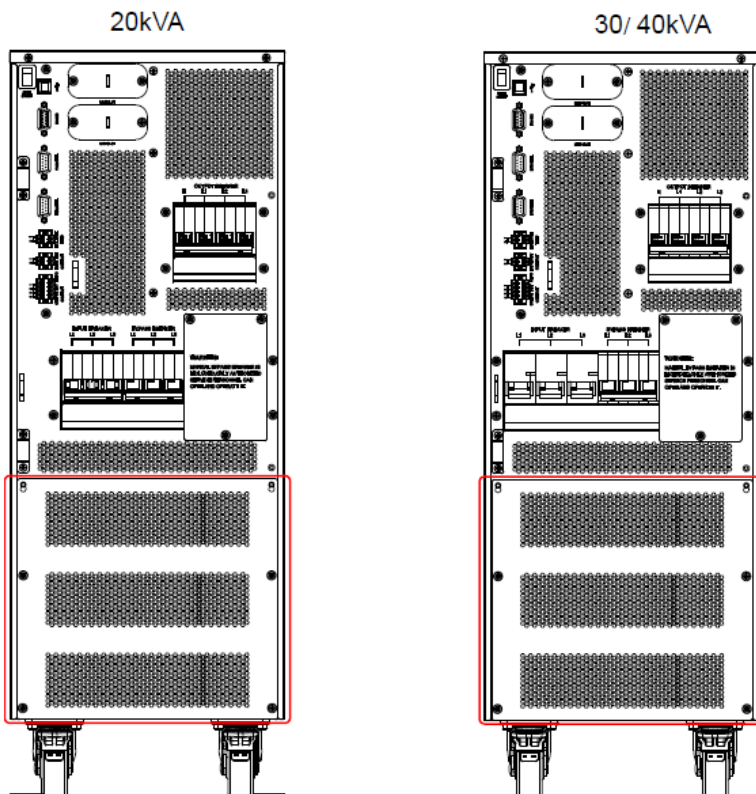

(Figure 5-5: Panel Location)

- After removing the panels, please follow the below method to modify the UPS from single input into dual input.

Remove the copper bars that connect the main input terminal block and bypass terminal block (mL1 & bL1, mL2 & bL2, mL3 & bL3) (please see **Figure 5-6**). When wiring, connect the main AC source's L1, L2 and L3 cables to the main input terminal block (mL1, mL2, mL3), and connect the bypass source's L1, L2 and L3 cables to the bypass terminal block (bL1, bL2, bL3).

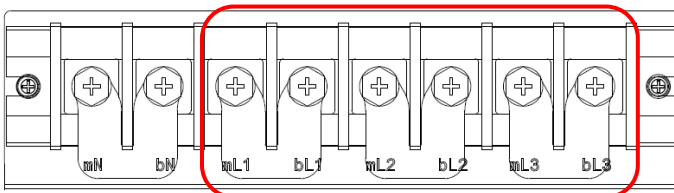

(Figure 5-6: Remove the Copper Bars)

5.5.3 Single Unit Wiring



NOTE:

Prior to wiring, please read **5.5.1 Precautions Prior to Wiring** first.



- **Single Input (Single Unit)**

When there is only one AC power source, single unit wiring procedures are as follows.

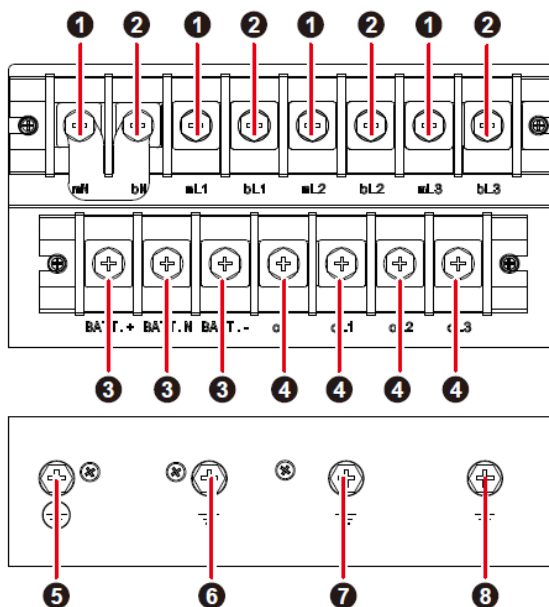
- Remove the cover shown in **Figure 5-5** and you will see the wiring terminal block shown below.



(Figure 5-7: Wiring Terminal Block)

No.	Item	Function	Description
①	Main Input Terminal Block	Connects the main AC source	Includes three-phase (mL1, mL2, mL3) and neutral (mN) terminals.
②	Bypass Terminal Block	Connects the Bypass source	Includes three-phase (bL1, bL2, bL3) and neutral (bN) terminals.
③	Battery Input Terminal Block	Connects an external battery cabinet.	Includes three terminals, positive (BATT.+), negative (BATT.-) and neutral (BATT.N).
④	UPS Output Terminal Block	Connects the critical loads.	Includes three-phase (oL1, oL2, oL3) and neutral (oN) terminals.
⑤		For the UPS system grounding	Includes one grounding terminal.
⑥		For the external battery cabinet's grounding	Includes one grounding terminal.
⑦		For the critical loads' grounding	Includes one grounding terminal.
⑧		For bypass grounding	Includes one grounding terminal.

2. The UPS rating voltage is 220/ 380Vac, 230/ 400Vac or 240/ 415Vac.
3. The battery rating voltage is ± 240 Vdc.
4. Confirm the input breaker and bypass breaker are in the **OFF** position.
5. According to the capacity and the model of your UPS, select proper input and output cables (please refer to **Table 5-1**).
6. Connect the main AC source/ output/ external battery cabinet cables to the wiring terminal block (please refer to **Figure 5-8**).



NOTE:

Regarding **Figure 5-8**, this figure represents that the main AC power is the TN system and a 3-pole backfeed protective device is installed between the UPS and the main AC power. If your main AC power is the TT system, please in- stall a backfeed 4-pole protective device between the UPS and the main AC power.

7. Ground the UPS.

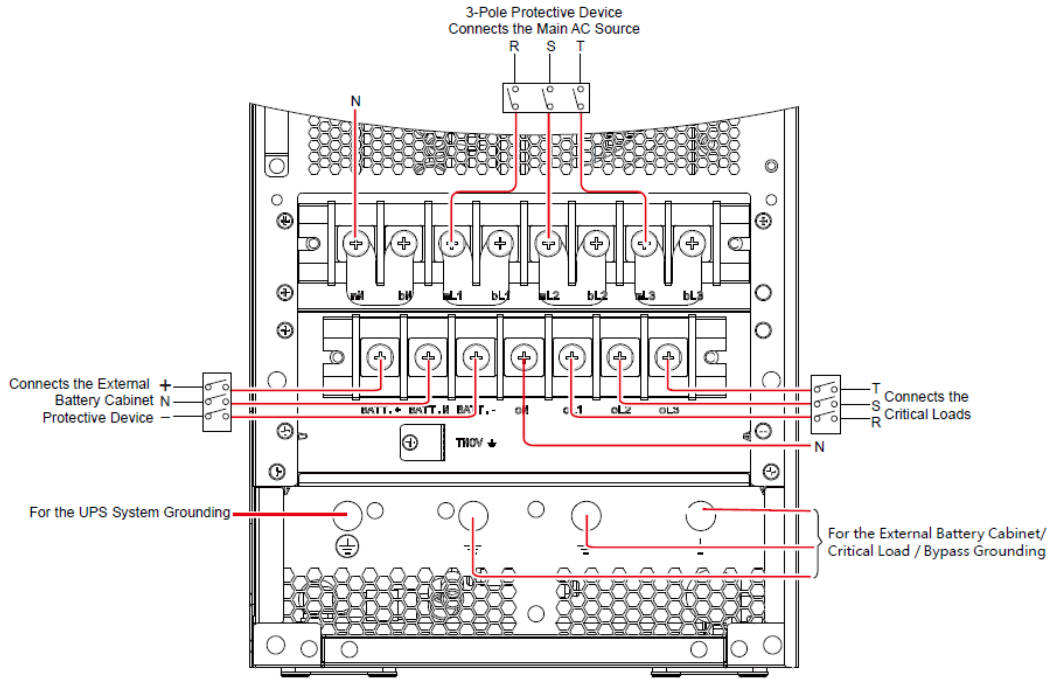

(Figure 5-8: 20/30/40kVA UPS Single Unit Single Input Wiring Diagram)

- **Dual Input (Single Unit)**

When there are two AC power sources, single unit wiring procedures are as follows.

1. Follow **5.5.2 Single Input/ Dual Input Modification** to modify the UPS into dual input. Please note that only authorized Delta engineers or service personnel can modify single input/ dual input setup.
2. Please follow steps 1~6 stated in section Single Input (Single Unit).
3. Connect the main AC source/ bypass source/ output/ external battery cabinet cables to the wiring terminal block (please refer to **Figure 5-9**).



NOTE:

Regarding **Figure 5-9**, this figure represents that the main AC power is the TN system and a 3-pole backfeed protective device is installed between the UPS and the main AC power. If your main AC power is the TT system, please install a 4-pole backfeed protective device between the UPS and the main AC power.

4. Ground the UPS.

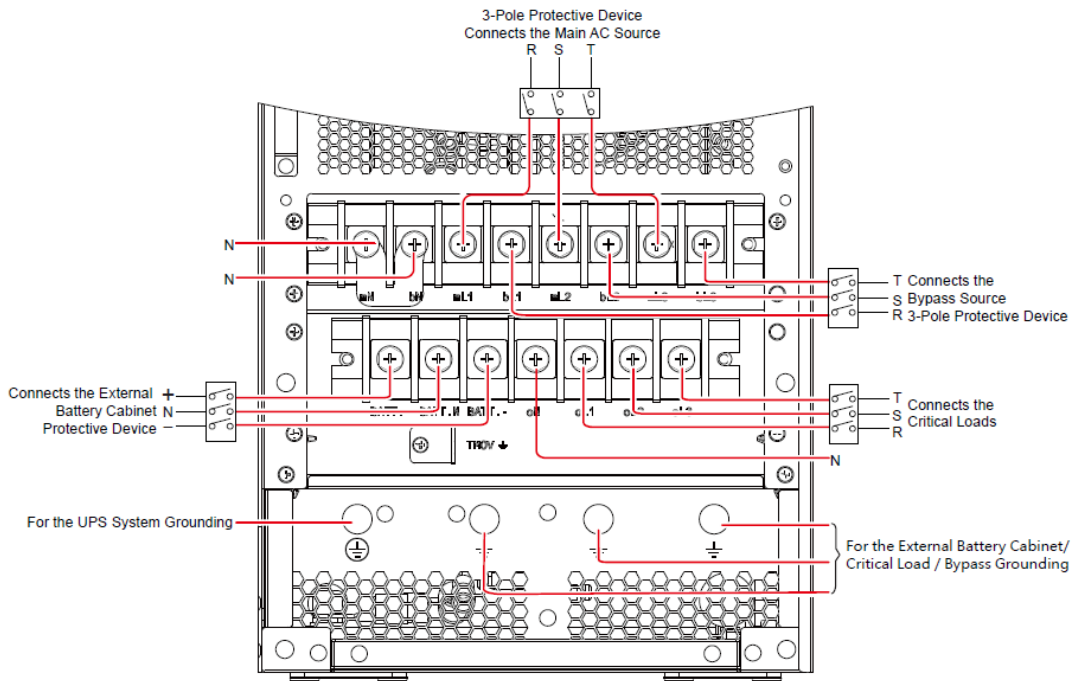

(Figure 5-9: 20/30/40kVA UPS Single Unit Dual Input Wiring Diagram)

5.5.4 Parallel Units Wiring



NOTE:

Prior to wiring, please read **Chapter 5.5.1 Precautions Prior to Wiring** first.

● Single Input (Parallel Units)

When there is only one AC power source, parallel unit's wiring procedures are as follows.

1. Please follow steps 1~6 stated in section **Single Input (Single Unit)**.
2. Connect the main AC source/ output/ external battery cabinet cables to the wiring terminal block (please refer to **Figures 5-8/ 5-10**).



NOTE:

Regarding **Figure 5-8**, this figure represents that the main AC power is the TN system and a 3-pole backfeed protective device is installed between the UPS and the main AC power. If your main AC power is the TT system, please install a 4-pole backfeed protective device between the UPS and the main AC power.

3. Use the provided parallel cable to connect the parallel ports on the parallel units. Please see **Figure 2-3~2-4** for parallel port location.
4. Ground the parallel UPSs.



WARNING:

1. When UPSs are paralleled, the length of each unit's input cables/ output cables must be equal. This ensures that the parallel UPSs can equally share the equipment loads in bypass mode.
2. Only UPSs with the same capacity, voltage and frequency can be paralleled; otherwise, parallel functions will fail.
3. Before startup of parallel units, Delta service personnel should set ID (1, 2, 3 or 4) through touch panel. Otherwise, UPSs cannot be started. If there is a conflict between ID numbers, a warning information will appear on touch panel correspondingly.

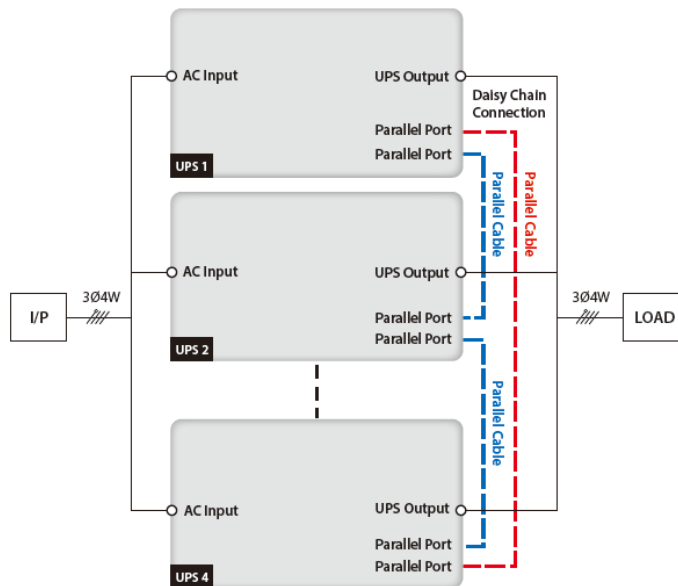

(Figure 5-10: Parallel Units Single Input Wiring Diagram)

● Dual Input (Parallel Units)

When there are two AC power sources, parallel units' wiring procedures are as follows.

1. Follow **Chapter 5.5.2 Single Input/ Dual Input Modification** to modify the UPS into dual input. Please note that only authorized Delta engineers or service personnel can modify single input/ dual input setup.
2. Please follow steps **1~6** stated in section **Single Input (Single Unit)**.
3. Connect the main AC source/ bypass source/ output/ external battery cabinet cables to the wiring terminal block (please refer to **Figures 5-9/ 5-11**).



NOTE:

Regarding **Figure 5-9**, this figure represents that the main AC power is the TN system and a 3-pole backfeed protective device is installed between the UPS and the main AC power. If your main AC power is the TT system, please install a 4-pole backfeed protective device between the UPS and the main AC power.

- 4. Use the provided parallel cable to connect the parallel ports on the parallel units. Please see **Figure 2-3~2-4** for parallel port location.
- 5. Ground the parallel UPSs.



WARNING:

- 1. When UPSs are paralleled, the length of each unit's bypass input cables/ output cables must be equal. This ensures that the parallel UPSs can equally share the equipment loads in bypass mode.
- 2. Only UPSs with the same capacity, voltage and frequency can be paralleled; otherwise, parallel functions will fail.
- 3. Before start-up of parallel units, qualified service personnel should set ID (1, 2, 3 or 4) through touch panel. Otherwise, UPSs cannot be started. If there is a conflict between ID numbers, a warning information will appear on touch panel correspondingly.

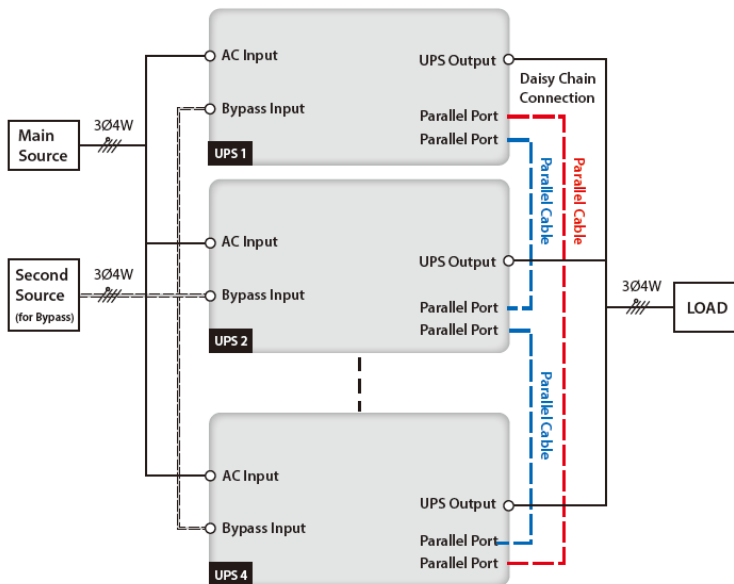

(Figure 5-11: Parallel Units Dual Input Wiring Diagram)

5.6 External Battery Cabinet Connection Precautions



WARNING:

1. You can connect loads to the UPS only after the batteries are fully charged. This guarantees that the UPS can provide sufficient backup power to the loads connected when a power failure occurs.
2. A battery can present a risk of electric shock and high short-circuit current. Servicing of batteries and battery cabinets must be performed or supervised by qualified service personnel knowledgeable in batteries, battery cabinets and the required precautions. Keep unauthorized personnel away from batteries and battery cabinets.

● Battery

1. Charge Voltage

- 1) Float voltage: $\pm 272\text{Vdc}$ (default)
- 2) Equalized voltage: $\pm 280\text{Vdc}$ (default)

2. Charge Current

UPS	Default	Minimum	Maximum
20kVA	3A	1A	15A
30kVA	3A	1A	15A
40kVA	3A	1A	15A

3. Low Battery Shutdown: 200Vdc (default)

4. The Number of Batteries in One String: Default_12Vdc x 40 pcs (± 20 pcs); Tolerance_12Vdc x 30pcs (± 15 pcs)~ 12Vdc x 46 pcs (± 23 pcs).



NOTE:

1. When the number of batteries on one string is 30~34, the UPS must be derated. For details, please contact Delta service personnel.
2. You can follow actual need to adjust the charge current from the minimum to the maximum. Each adjustment level is 1A.
3. If you need to modify the charge current default setting and low battery shutdown default setting, please contact your local dealer or Delta service personnel.



WARNING:

The parameter setting of the number of batteries must be consistent with the actual number of batteries installed, otherwise the battery will be overcharged or undercharged, and the battery may be damaged.

- Only use the same type of batteries from the same supplier. Never use old, new and different Ah batteries at the same time.
- The number of batteries must meet UPS requirements.
- Do not connect the batteries in reverse.
- Use the voltage meter to measure whether the total voltage, after the external battery string connection, is around $12.5\text{Vdc} \times$ the total number of batteries.
- To extend battery backup time, you can connect several external battery strings (1~9) to the UPS. Please note that the number of the batteries in each paralleled external battery string must be the same.
- The default number of batteries is 40 pcs of 12V batteries connected in one string, and you should connect the external battery cabinet's neutral to the middle 20th and 21st batteries. You should use three cables to connect the external battery cabinet with the 'BATT. +', 'BATT. -' and 'BATT. N' terminals marked on the UPS. Please refer to the below figure.

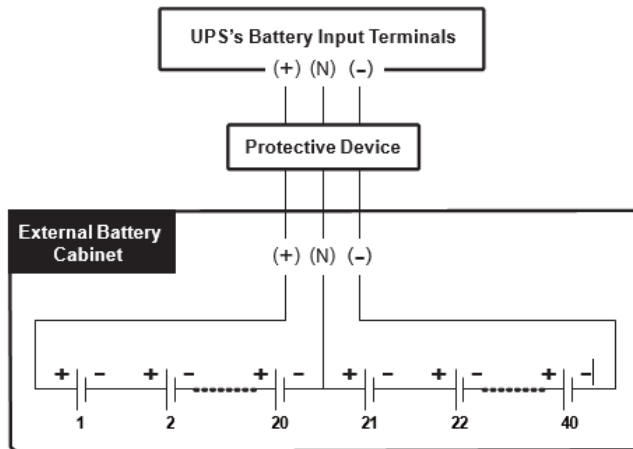

(Figure 5-12: External Battery Cabinet Connection)

- Please follow your UPS's rating to install an appropriate protective device for the external battery cabinet. You can choose to install either an isolated switch connected in series with a DC fuse or a DC circuit breaker. Please refer to the below table.

UPS Rating	20kVA	30kVA	40kVA
DC Fuse (Voltage \geq 500Vdc)	50 A	75 A	100 A
4-Pole DC Circuit Breaker (Per pole voltage \geq 250Vdc)	50 A	75 A	100 A
3-Pole DC Circuit Breaker (Per pole voltage \geq 500Vdc)	50 A	75 A	100 A
Battery Cable	6AWG/10mm ²	4AWG/ 16mm ²	2AWG/ 25mm ²

(Table 5-2: External Battery Cabinet's Protective Device)



NOTE:

1. The above mentioned DC fuse and DC circuit breaker are optional. For details, please contact Delta service personnel.
 2. If you need to parallel multiple strings of external battery, please contact Delta service personnel for relevant information.
- The external battery cabinet's protective device must be planned and designed by qualified service personnel. The protective device could be either an isolated switch connected in series with a DC fuse or a DC circuit breaker; please refer to **Table 5-2**. When choosing the external battery cabinet's protective device, please take the following factors into consideration: (1) overcurrent between the UPS and battery circuit, (2) fault current, (3) wire/ cable material, and (4) local electrical regulations. If you have any questions about the external battery cabinet's protective device, please contact Delta service personnel. Please refer to **Figure 5-13~5-15** for the installation of the external battery cabinet's protective device.

Option 1: An isolated switch connected in series with a DC fuse

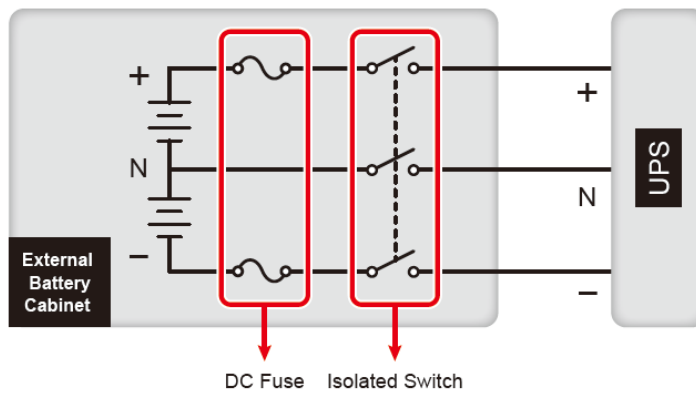

(Figure 5-13: Installation of An Isolated Switch Connected in Series with a DC Fuse)

Option 2: A DC circuit breaker

- 1) 4-pole DC circuit breaker (per pole voltage $\geq 250\text{Vdc}$)

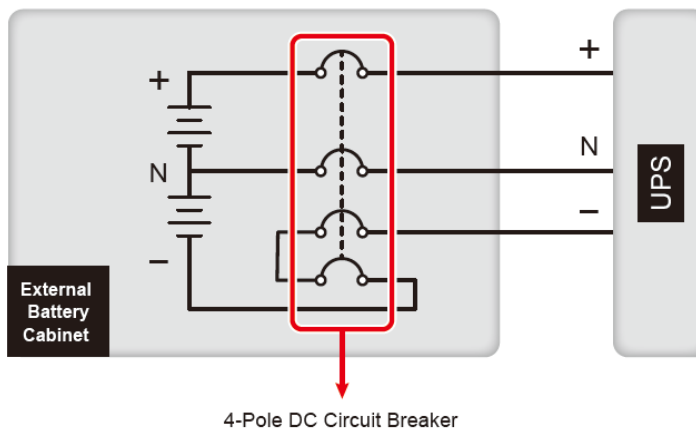

(Figure 5-14: Installation of a 4-Pole DC Circuit Breaker)

2) 3-pole DC circuit breaker (per pole voltage $\geq 500\text{Vdc}$)

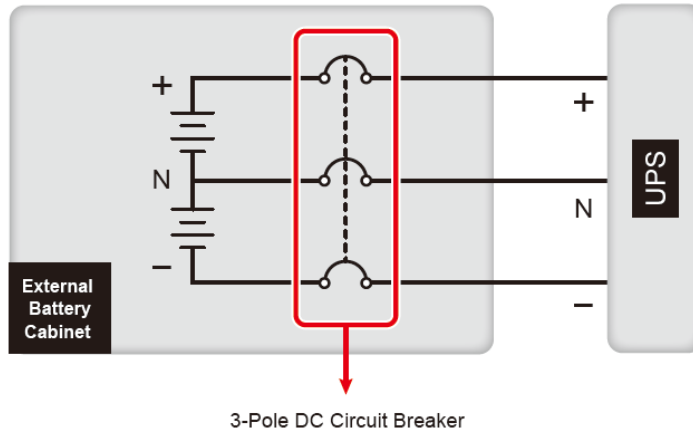

(Figure 5-15: Installation of a 3-Pole DC Circuit Breaker)

- The parallel UPSs can connect with common batteries.



WARNING:

Each block of battery needs to be insulated with metal of cabinet (Earth) when battery assembly.

- External Battery Cabinet Alarm

When an external battery cabinet connected to the UPS has the following problems, the UPS system will sound an alarm. Please see the table below.

No.	External Battery Cabinet Status	Alarm
1	Battery Test Fail	Sounds once every 0.5 seconds.
2	Battery End of Discharge Imminent	Sounds once every 0.5 second.
3	Battery End of Discharge	Long beep (5 seconds).
4	Battery Over Charge	Long beep.
5	Battery Missing	Sounds once every 0.5 seconds.

Chapter 6: UPS Operation

6.1 Pre Start-up & Pre Turn-off Warnings for Single Unit and Parallel Units



NOTE:

1. All the information on the touch panel presented in this chapter, including the UPS operation mode, machine number, date, time, total number of warnings, load%, battery remaining time, user login or administrator login, are for reference only. The actual screen displayed will depend on the actual operation situation.
2. Before operation, please make sure that **Chapter 5: Installation and Wiring** has been completed in compliance with the relevant instructions.
3. Before operation, please refer to **Table 2-1 Tri-color LED Indicator & Buzzers** and **Chapter 7.4 Introduction of Touch Panel and Function Keys**.

Single Unit

● Pre Start-up Warnings for Single Unit

1. Make sure that all the breakers, including each external battery cabinet's breaker, are turned to the **OFF** position.
2. Check if the wiring is correct. Ensure that the input power's voltage, frequency, phase and battery type meet the UPS's requirements.

● Pre Turn-off Warnings for Single Unit

If you perform turn-off procedures for single unit, all power will be completely cut off. Please make sure the critical loads connected to the UPS have already been safely shut down before you perform the turn-off procedures.

Parallel Units

● Pre Start-up Warnings for Parallel Units

1. You can parallel at maximum four UPS units.
2. For parallel units, ensure that each parallel cable (provided) is connected well.
3. Make sure that all of breakers, including every external battery cabinet's breaker, are turned to the **OFF** position.
4. Check if the wiring is correct. Ensure that the input power's voltage, frequency, phase and battery type meet the UPS's requirements.

5. For parallel units, ensure that every operation procedure mentioned below is synchronized to all parallel UPSs.
6. For parallel application, if you just want to operate a specific UPS but not all parallel ones, please contact Delta service personnel.

- **Pre Turn-off Warnings for Parallel Units**

1. If you want to turn off one of the parallel UPSs, please check whether the remaining parallel units' total capacity exceeds the total critical loads. If the remaining parallel units' total capacity is less than the total critical loads, all parallel units will shut down due to overload.
2. If you perform turn-off procedures for all parallel UPSs, all power will be completely cut off. Please make sure that the critical loads connected to the parallel UPSs have already been safely shut down before you perform the turn-off procedures.

6.2 Start-up Procedures

6.2.1 Online Mode Start-up Procedures



WARNING:

3. For parallel units, please follow **Chapter 6.2.3 Bypass Mode Start-up Procedures** to turn on each parallel UPS. After confirming that parallel operation can be normally run, follow the following procedures step by step.
 4. For parallel units, ensure that every operation procedure mentioned below is synchronized to all parallel UPSs.
 5. For parallel application, if you just want to operate a specific UPS but not all parallel ones, please contact Delta service personnel.
1. Ensure that the manual bypass breaker is in the **OFF** position.
 2. Switch **ON** each external battery cabinet's breaker.
 3. **Single Input:** Switch **ON** the bypass breaker, the input breaker and the output breaker.
Dual Input: Switch **ON** the bypass breaker, the input breaker, and the output breaker.
 4. After you switch **ON** the bypass breaker and input breaker, the UPS will start up, the main screen will appear after about 25 seconds and the tri-color LED indicator will illuminate yellow. Please see the below figure.

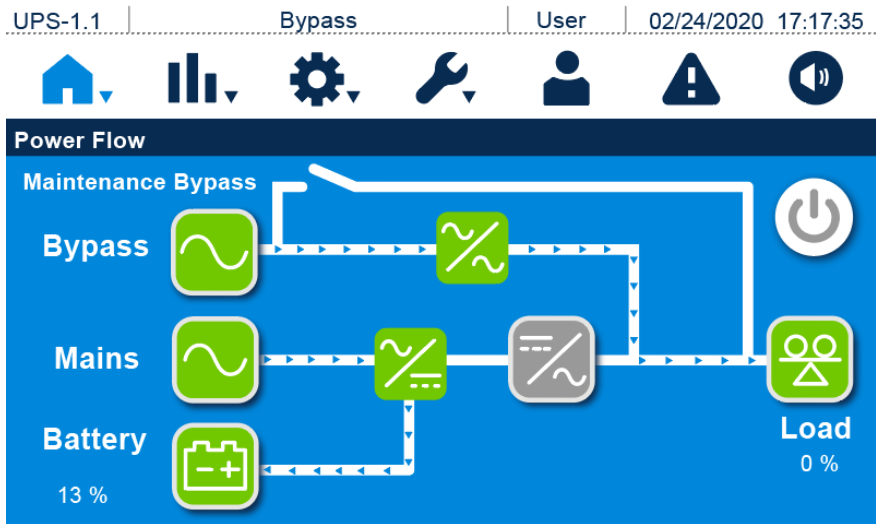

(Figure 6-1: Main Screen)

- Press the ON/ OFF button () once and the following screen will pop up to ask you if you want to power on the UPS's inverter. If yes, please select '**Power On**'. Please refer to the below figure.

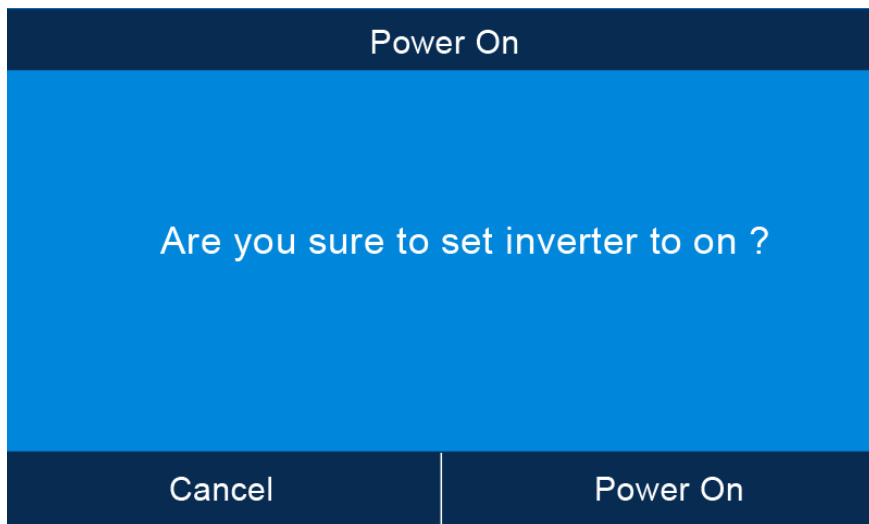

(Figure 6-2: Power On Reminder Screen)

6. After selection of 'Power On' to start up the UPS's inverter, the UPS will start up and perform self-inspection. After the self-inspection is completed, the UPS will automatically transfer to run in online mode, the tri-color LED indicator will illuminate green and the following screen will appear.

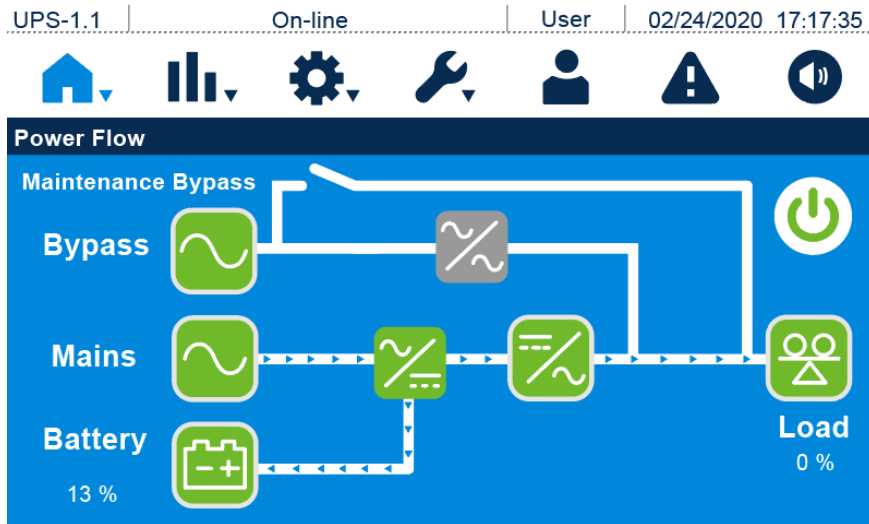

(Figure 6-3: Online Mode Screen)

6.2.2 Battery Mode Start-up Procedures



WARNING:

1. For parallel units, please follow **Chapter 6.2.3 Bypass Mode Start-up Procedures** to turn on each parallel UPS. After confirming that parallel operation can be normally run, follow the following procedures step by step.
 2. For parallel units, ensure that every operation procedure mentioned below is synchronized to all parallel UPSs.
 3. For parallel application, if you just want to operate a specific UPS but not all parallel ones, please contact Delta service personnel.
1. Ensure that the manual bypass breaker is in the **OFF** position.
 2. Switch **ON** each external battery cabinet's breaker.
 3. Switch **ON** the output breaker.
 4. Press the BATT. START button on rear panel of the UPS for 3 seconds until you hear one beep, and release it. After that, the UPS will start up. After the UPS output is turned on, the tri-color

LED indicator will illuminate yellow and the following screen will appear.

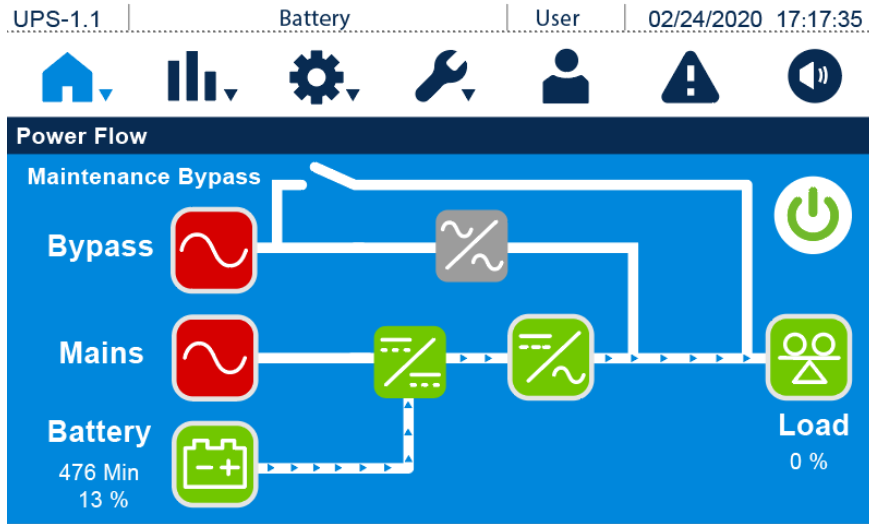

(Figure 6-4: Battery Mode Screen)

6.2.3 Bypass Mode Start-up Procedures



WARNING:

1. For parallel units, ensure that every operation procedure mentioned below is synchronized to all parallel UPSs.
2. For parallel application, if you just want to operate a specific UPS but not all parallel ones, please contact Delta service personnel.

1. Ensure that the manual bypass breaker is in the **OFF** position.
2. Switch **ON** each external battery cabinet's breaker.
3. **Single Input:** Switch **ON** the bypass breaker and the input breaker.
Dual Input: Switch **ON** the bypass breaker and the input breaker.
4. After you switch **ON** the bypass breaker, input breaker, the UPS will start up, the main screen will appear after about 25 seconds and the tri-color LED indicator will illuminate yellow. Please see the below figure.

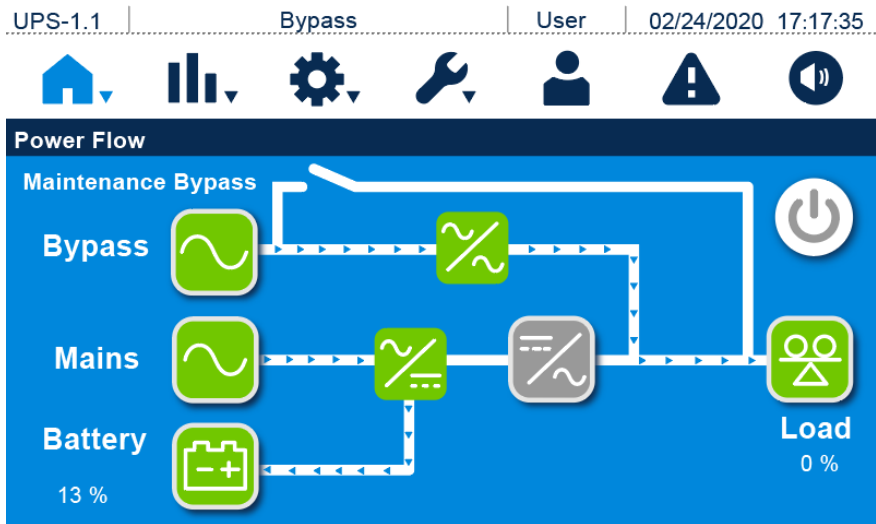

(Figure 6-5: Main Screen)

5. For parallel application, please check each parallel UPS's parallel settings. Please note that each parallel UPS's parallel ID No. must be different, and parallel group No., input, output and battery settings must be the same.
6. For parallel application, (M) & (S) will appear behind each parallel UPS's parallel ID No. and parallel group No. which is located in the upper left corner of the screen. The UPS with (M) is master unit, and the one with (S) is slave unit, e.g. UPS-1.2 (M). Please see the below figure.

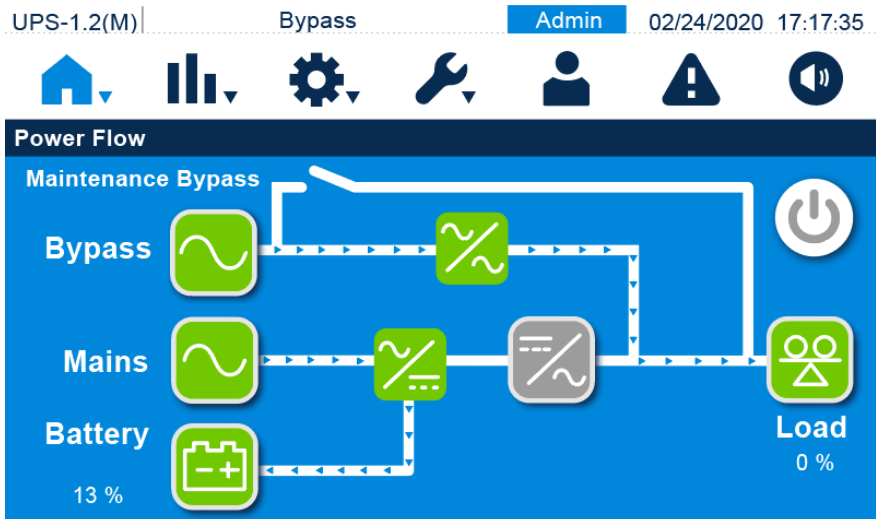

(Figure 6-6: Parallel UPS Status)

7. For single unit, switch **ON** the output breaker.
For parallel units, switch **ON** the output breaker.

Now, the tri-color LED indicator illuminates yellow and the screen shows as follows

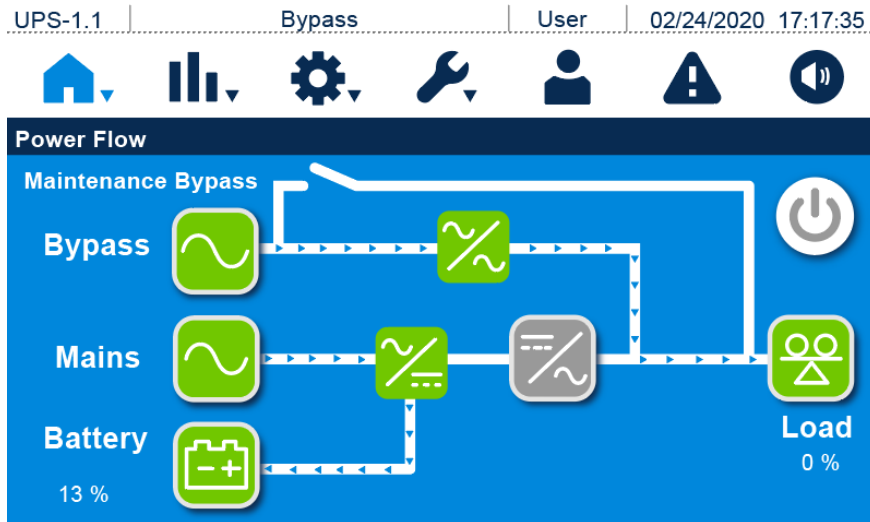

(Figure 6-7: Bypass Mode Screen)

6.2.4 Manual Bypass Mode Start-up Procedures



WARNING:

1. For parallel units, ensure that every operation procedure mentioned below is synchronized to all parallel UPSs.
2. For parallel application, if you just want to operate a specific UPS but not all parallel ones, please contact Delta service personnel.
3. Please note that you can switch on the manual bypass breaker only when the UPS needs maintenance. In manual bypass mode, the connected critical loads will be supplied by the manual bypass and the output won't be protected. Please ensure that the bypass AC source is normal.
4. In manual bypass mode, the connected critical loads will be supplied by the manual bypass; thus, maintenance personnel can perform maintenance without interrupting the power supplying to the critical loads.
5. Ensure that all of the breakers (except manual bypass breaker) are in the **OFF** position, and use a voltmeter to check there is no high voltage inside the UPS. Only after confirmation can service personnel perform UPS maintenance.
6. Please note that, during UPS maintenance process, **DO NOT** touch the main input, bypass and output terminal block to avoid electric shock.

- **Switching from online mode to manual bypass mode**

1. When the UPS is in online mode, the main screen will appear shown in the figure below. At this time, the tri-color LED indicator will illuminate green.

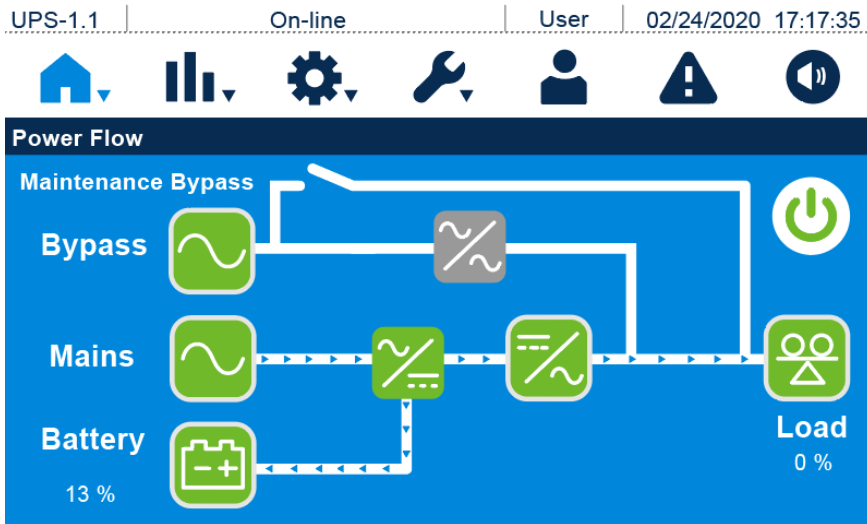

(Figure 6-8: Online Mode Screen)

2. Press the ON/ OFF button () once and the following screen will pop up to ask you if you want to power off the UPS's inverter. If yes, please select '**Power Off**'. If not, please select '**Cancel**'.

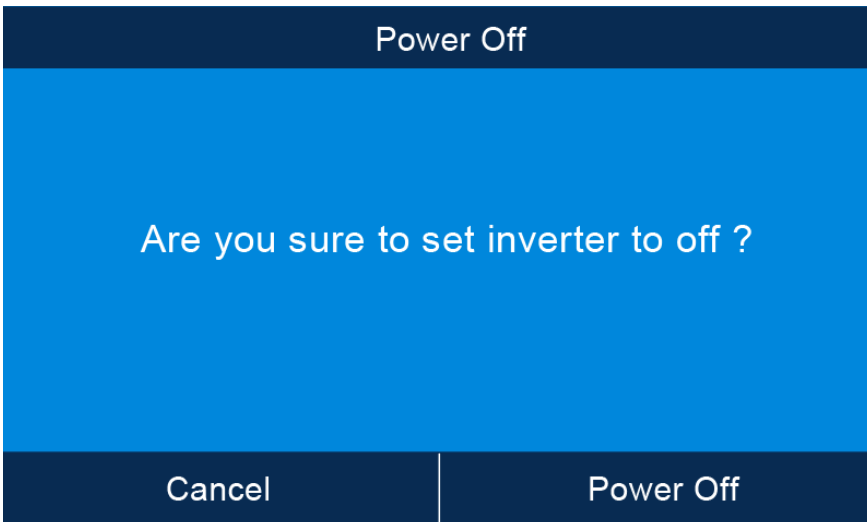

(Figure 6-9: Power Off Reminder Screen)

3. Check if the bypass voltage and static switch are normal or not. If normal, please select **'Power Off'**. After that, the UPS will shut down the inverter and transfer to run in bypass mode.
4. Ensure that the UPS runs in bypass mode. After that, switch **ON** the manual bypass breaker. And now, the screen will show as follows.

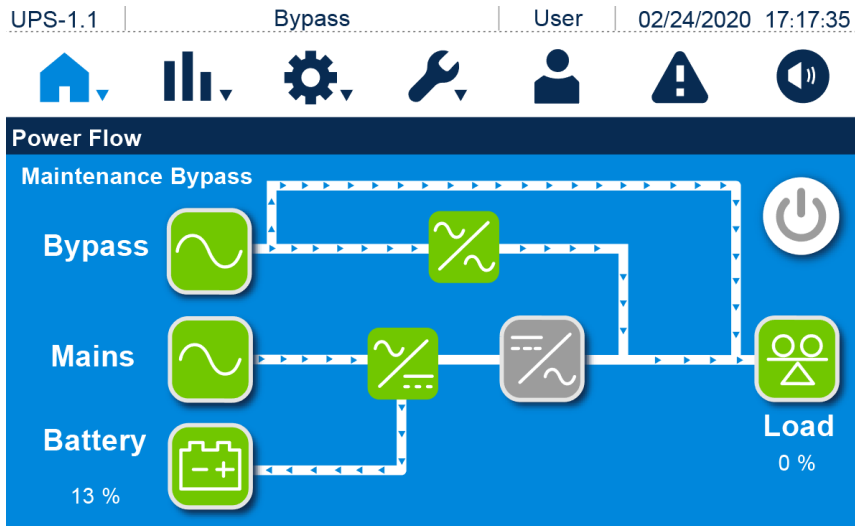

(Figure 6-10: Manual Bypass Mode Screen)

5. **Single Input:** Switch **OFF** the Bypass breaker, input breaker and output breaker.
Dual Input: Switch **OFF** the Bypass breaker, input breaker and output breaker.
6. The UPS will discharge DC bus voltage, and the tri-color LED indicator will illuminate yellow. After discharging is completed, the UPS will shut down, and the touch panel and the tri-color LED indicator will be off.
7. Switch OFF each external battery cabinet's breaker.

● **Switching from manual bypass mode to online mode**



WARNING:

1. For parallel units, ensure that every operation procedure mentioned below is synchronized to all parallel UPSs.
2. For parallel application, if you just want to operate a specific UPS but not all parallel ones, please contact Delta service personnel.

1. Switch **ON** each external battery cabinet's breaker.

2. **Single Input:** Switch **ON** the bypass breaker, input breaker and output breaker.
Dual Input: Switch **ON** the bypass breaker, input breaker and output breaker.
3. Switch **ON** the input breaker and bypass breaker, the UPS will start up, and the main screen will appear after about 25 seconds.
4. If the bypass voltage is within the normal range, the UPS will transfer to run in bypass mode, the screen will show as follows, and the tri-color LED indicator will illuminate yellow.

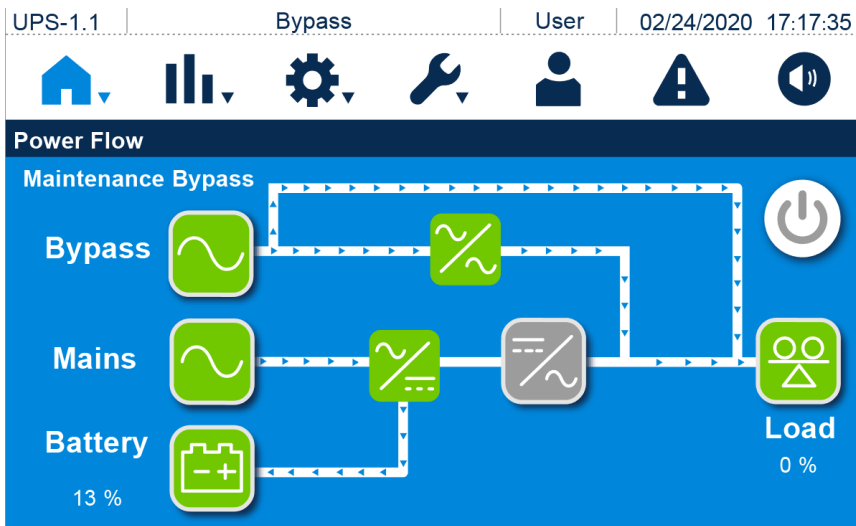

(Figure 6-11: Manual Bypass Mode Screen)

5. Switch **OFF** the manual bypass breaker, and lock the cover of manual bypass breaker.
6. Press the ON/ OFF button () once and the following screen will pop up to ask you if you want to power on the UPS's inverter. If yes, please select '**Power On**'.

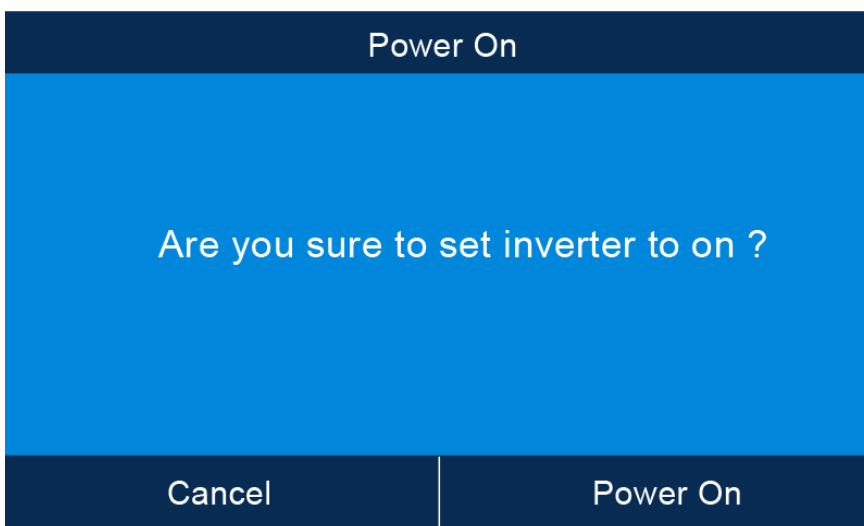

(Figure 6-12: Power On Reminder Screen)

- After selection of '**Power On**' to start up the inverter, the UPS will start up and perform self-inspection. At the same time, the UPS begins synchronization with the bypass AC source. After the self-inspection is completed, the UPS will automatically transfer to run in online mode, the tri-color LED indicator will illuminate green and the following screen will appear.

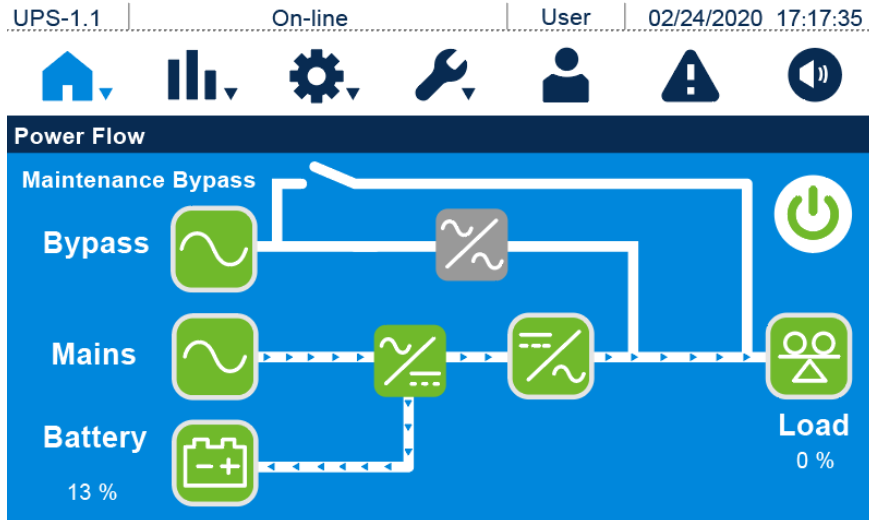

(Figure 6-13: Online Mode Screen)

6.2.5 ECO Mode Start-up Procedures



WARNING:

- For parallel units, please follow **6.2.3 Bypass Mode Start-up Procedures** to turn on each parallel UPS. After confirming that parallel operation can be normally run, follow the following procedures step by step.
 - For parallel units, ensure that every operation procedure mentioned below is synchronized to all parallel UPSs.
 - For parallel application, if you just want to operate a specific UPS but not all parallel ones, please contact Delta service personnel.
- Ensure that the manual bypass breaker is in the **OFF** position.
 - Switch **ON** each external battery cabinet's breaker.
 - Single Input:** Switch **ON** the bypass breaker, the input breaker and the output breaker.
Dual Input: Switch **ON** the bypass breaker, the input breaker and the output breaker.
 - After you switch **ON** the bypass breaker and input breaker, the UPS will start up, the main screen will appear after about 25 seconds, and the tri-color LED indicator will illuminate yellow. And now, the UPS keeps running and the tri-color LED indicator will illuminate yellow. After

UPS finishes establishing DC BUS voltage, the charger will start to charge the batteries. If the bypass voltage is within the normal range, the UPS will transfer to run in bypass mode, the screen will show as follows, and the tri-color LED indicator will illuminate yellow.

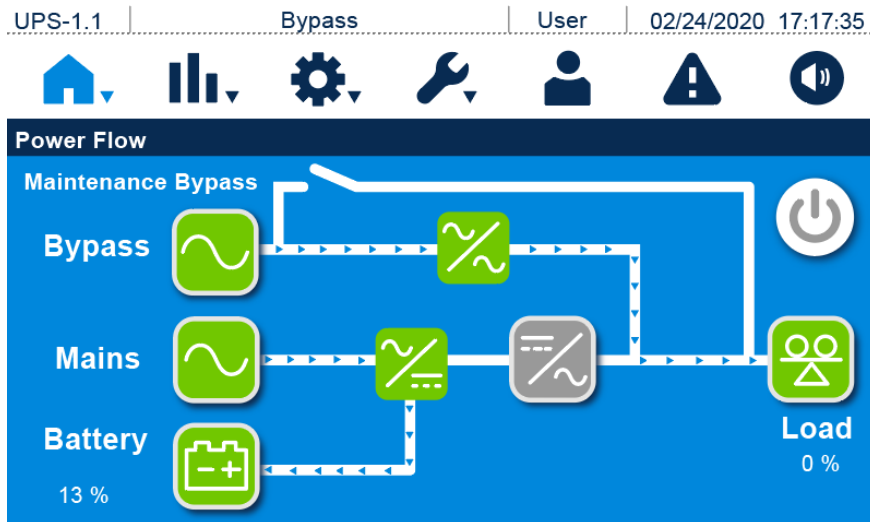

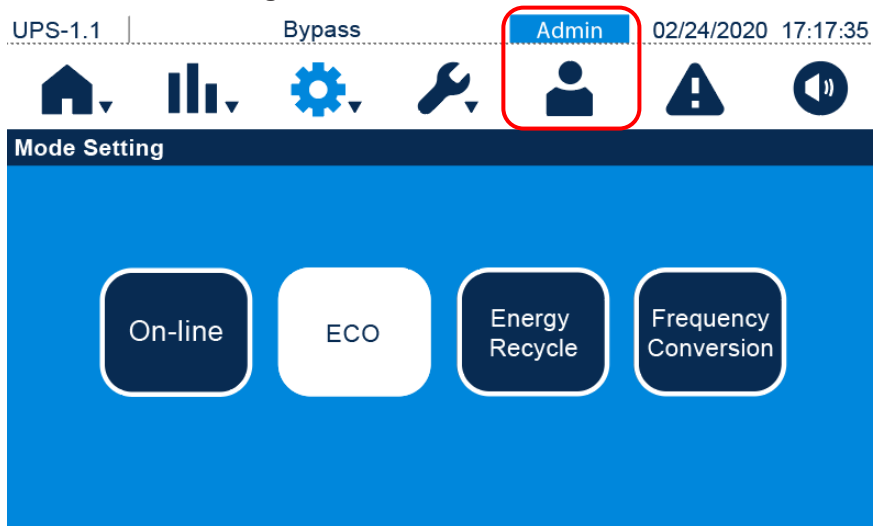

(Figure 6-14: Main Screen)

5. Please log in as an **Administrator**. For the **Administrator** password, please contact Delta service personnel. After login, ensure that you are in the **Administrator** login status.
6. Click **SETUP** → **Mode Setting** → **ECO**.



(Figure 6-15: Select ECO Mode)

7. After manually selecting **ECO** mode via the touch panel, press the icon () located in the upper left corner of the screen to go back to the **Main Screen**.
8. Press the ON/ OFF button () once and the following screen will pop up to ask you if you want to power on the UPS's inverter. If yes, please select '**Power On**'.

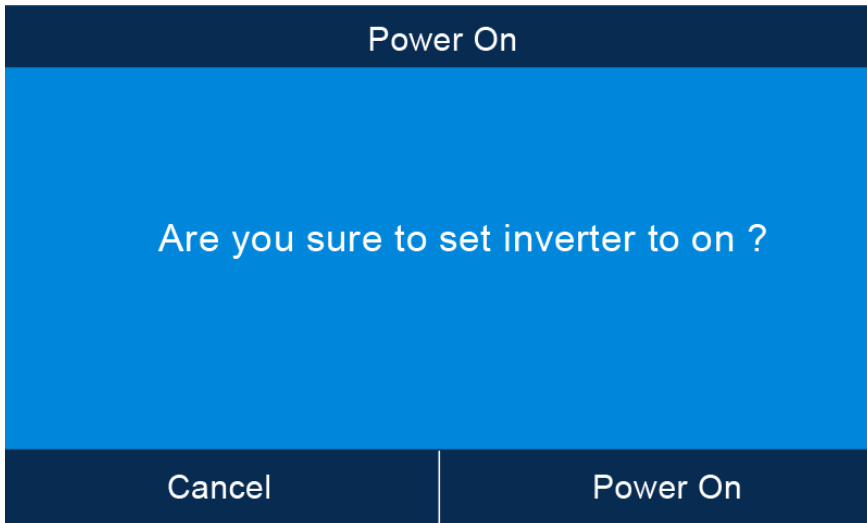

(Figure 6-16: Power On Reminder Screen)

9. After selection of '**Power On**' to start up the UPS's inverter, the UPS will start up and perform self-inspection. At the same time, the UPS begins synchronization with the bypass AC source. After the self-inspection is completed, the UPS will automatically transfer to run in online mode, After the system confirms that the bypass voltage is normal, the UPS will automatically switch to run in ECO mode to let the bypass AC source supply power. the tri-color LED indicator will illuminate green and the following screen will appear.

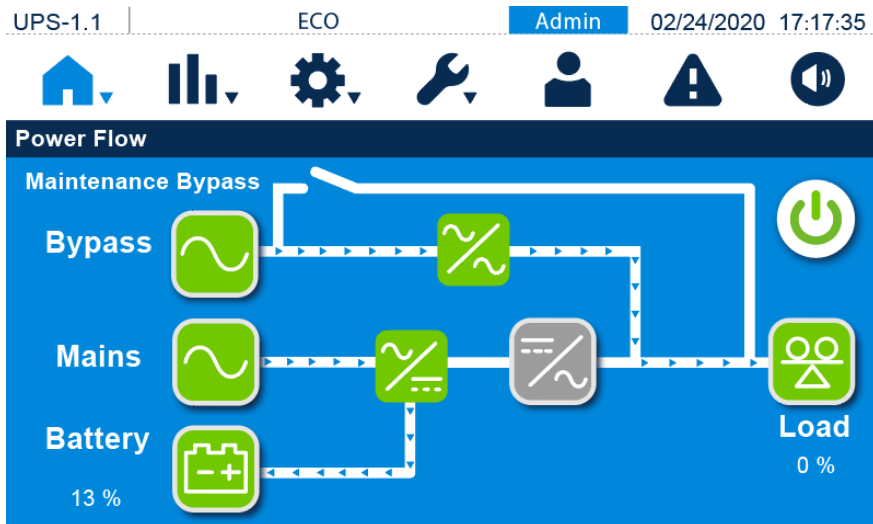

(Figure 6-17: ECO Mode Screen)

6.2.6 Frequency Conversion Mode Start-up Procedures



WARNING:

1. For parallel units, please follow **6.2.3 Bypass Mode Start-up Procedures** to turn on each parallel UPS. After confirming that parallel operation can be normally run, follow the following procedures step by step.
 2. For parallel units, ensure that every operation procedure mentioned below is synchronized to all parallel UPSs.
 3. For parallel application, if you just want to operate a specific UPS but not all parallel ones, please contact Delta service personnel.
1. Ensure that the manual bypass breaker is in the **OFF** position.
 2. Switch **ON** each external battery cabinet's breaker.
 3. **Single Input:** Switch **ON** the bypass breaker, the input breaker and the output breaker.
Dual Input: Switch **ON** the bypass breaker, the input breaker, and the output breaker.
 4. After you switch **ON** the bypass breaker and the input breaker, the UPS will start up, the main screen will appear after about 25 seconds and the tri-color LED indicator will illuminate yellow. After the UPS finishes establishing DC BUS voltage, the charger will start to charge the batteries. If the bypass voltage is within the normal range, the UPS will transfer to run in bypass mode, the screen will show as follows, and the tri-color LED indicator will illuminate yellow.

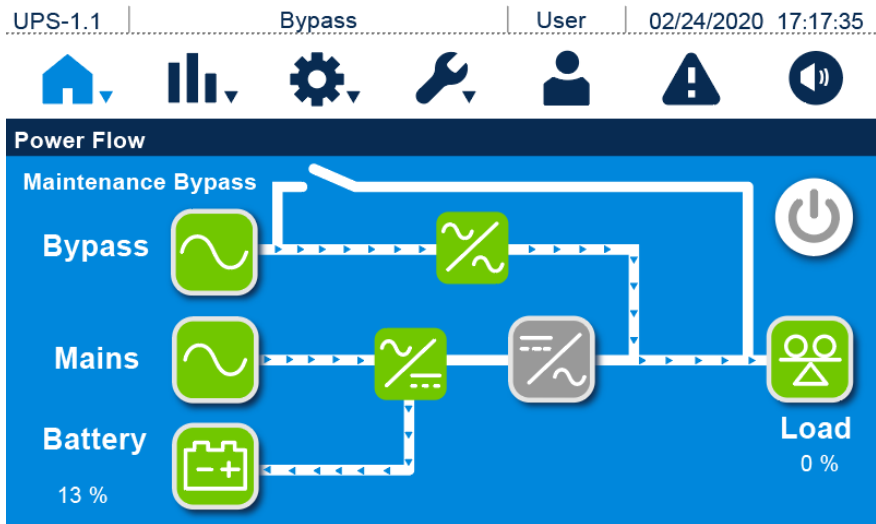

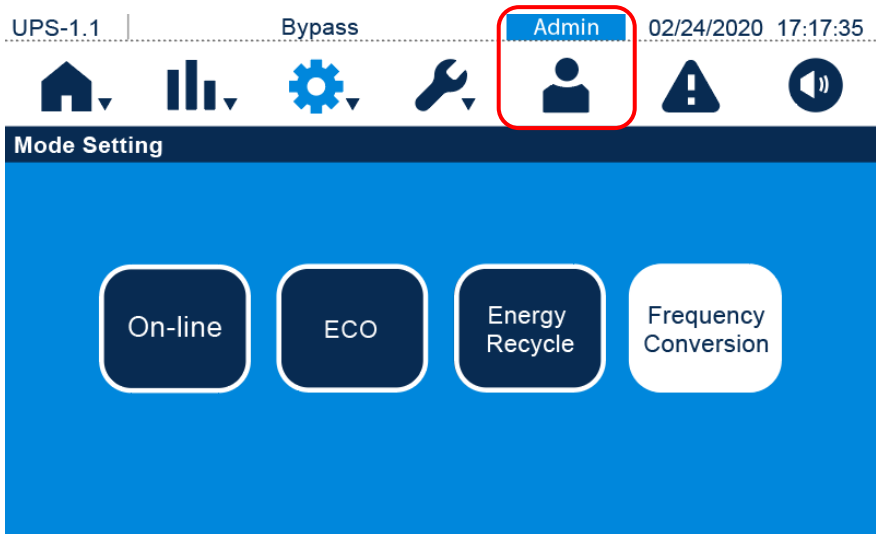

(Figure 6-18: Main Screen)

5. Please log in as an **Administrator**. For the **Administrator** password, please contact Delta service personnel. After login, ensure that you are in the **Administrator** login status.
6. Click **SETUP** → **Mode Setting** → **Frequency Conversion**.



(Figure 6-19: Select Frequency Conversion Mode)

7. After manually selecting **Frequency Conversion** mode via the touch panel, the UPS will run in standby mode and the output will be terminated.
8. Press the icon () located in the upper left corner of the screen to go back to the **Main Screen**.

9. Press the ON/ OFF button () once and the following screen will pop up to ask you if you want to power on the UPS's inverter. Please select 'Power On'.

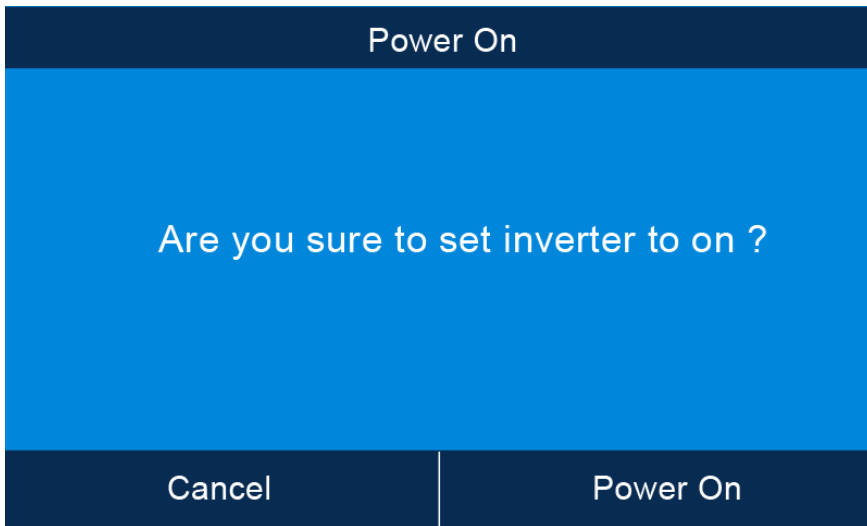

(Figure 6-20: Power On Reminder Screen)

10. After selection of 'Power On' to start up the UPS's inverter, the UPS will start up and perform self-inspection. After the self-inspection is completed, the UPS will automatically transfer to run in frequency conversion mode and the output frequency will be the same as setup value. Now, the tri-color LED indicator illuminates green and the following screen appears.

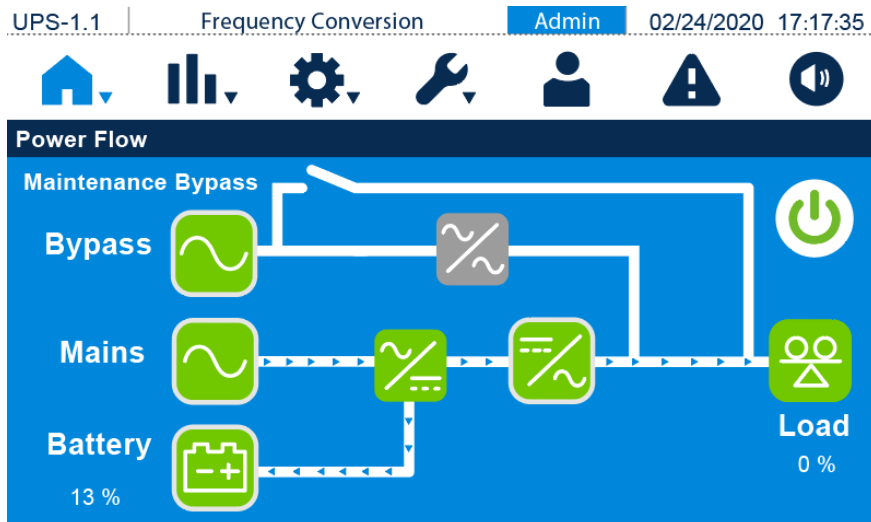

(Figure 6-21: Frequency Conversion Mode)

6.2.7 Energy Recycle Mode Start-up Procedures



WARNING:

1. Energy mode is just for UPS self-loading test, and is only applicable for single unit single input. The output does not need to take any load.
 2. In energy recycle mode, the charger is turned off.
-
1. Ensure that the manual bypass breaker and the output breaker are in the **OFF** position.
 2. Switch **ON** each external battery cabinet's breaker.
 3. Switch **ON** the bypass breaker and the input breaker.
 4. After you switch **ON** the bypass breaker and the input breaker, the UPS will start up, the main screen will appear after about 25 seconds and the tri-color LED indicator will illuminate yellow. After the UPS finishes establishing DC BUS voltage, the charger will start to charge the batteries. If the bypass voltage is within the normal range, the UPS will transfer to run in bypass mode, the screen will show as follows, and the tri-color LED indicator will illuminate yellow.

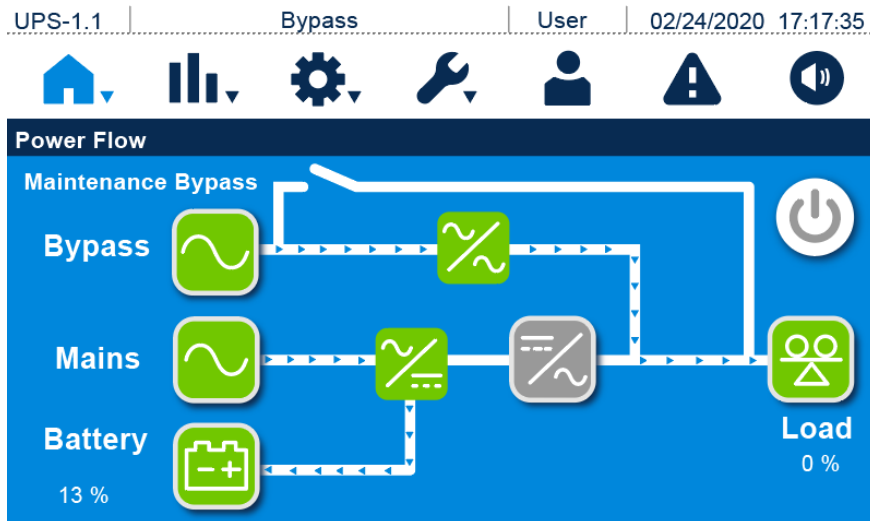

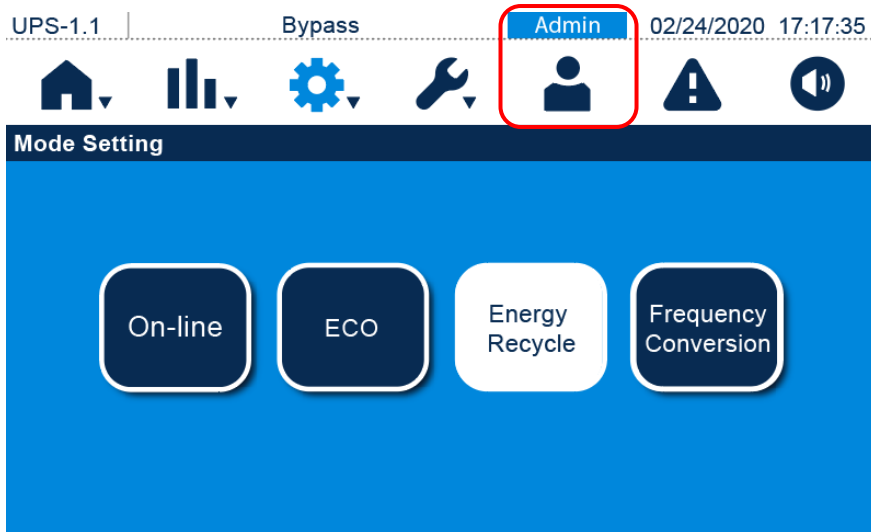

(Figure 6-22: Main Screen)

5. Please log in as an **Administrator**. For the **Administrator** password, please contact Delta service personnel. After login, ensure that you are in the **Administrator** login status.
6. Click **SETUP** → **Mode Setting** → **Energy Recycle**.



(Figure 6-23: Select Energy Recycle Mode)

7. After manually selecting **Energy Recycle** mode via the touch panel, press the icon () located in the upper left corner of the screen to go back to the **Main Screen**.
8. Press the ON/ OFF button () once and the following screen will pop up to ask you if you want to power on the UPS's inverter. If yes, please select '**Power On**'.

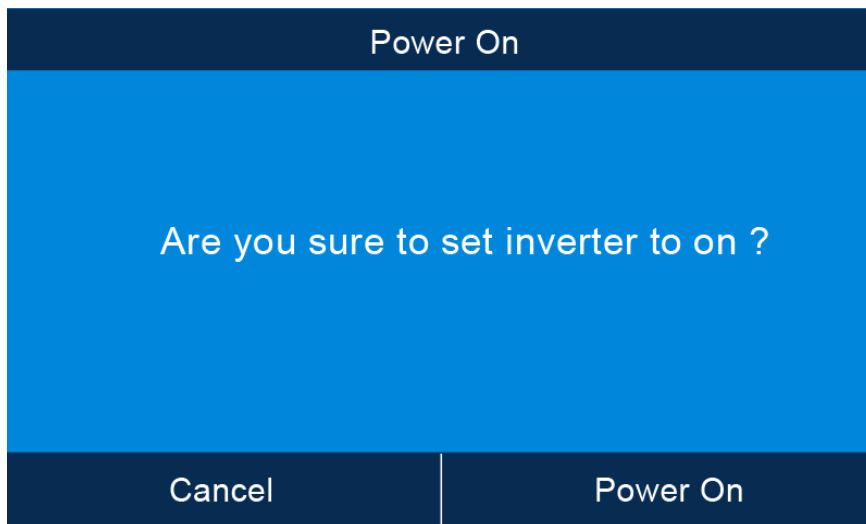

(Figure 6-24: Power On Reminder Screen)

9. After selection of 'Power On' to start up the UPS's inverter, the UPS will start up and perform self-inspection. After the self-inspection is completed, the UPS will automatically transfer to run in energy recycle mode. Now, the tri-color LED indicator illuminates green and the following screen appears.

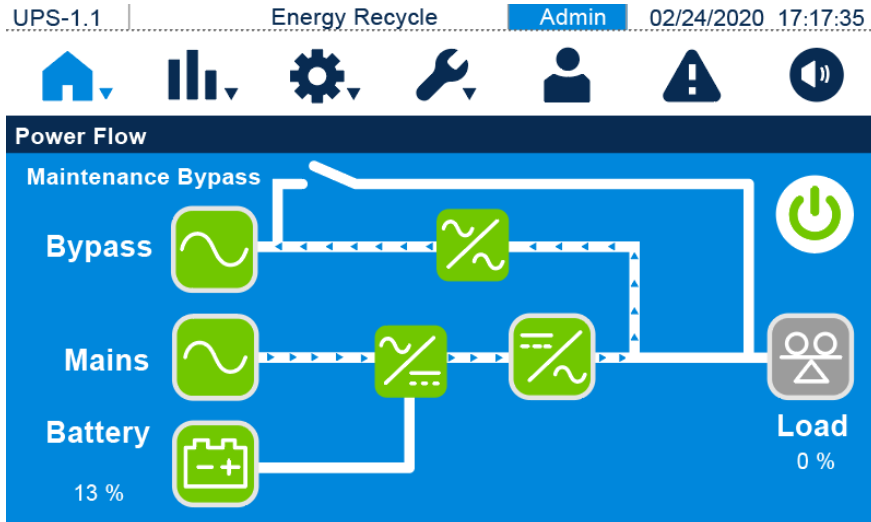

(Figure 6-25: Energy Recycle Mode)

6.3 Turn-off Procedures

6.3.1 Online Mode Turn-off Procedures



WARNING:

1. For parallel units, ensure that every operation procedure mentioned below is synchronized to all parallel UPSs.
2. For parallel application, if you just want to operate a specific UPS but not all parallel ones, please contact Delta service personnel.

1. In online mode, the touch panel shows the following screen and the tri-color LED indicator illuminates green.

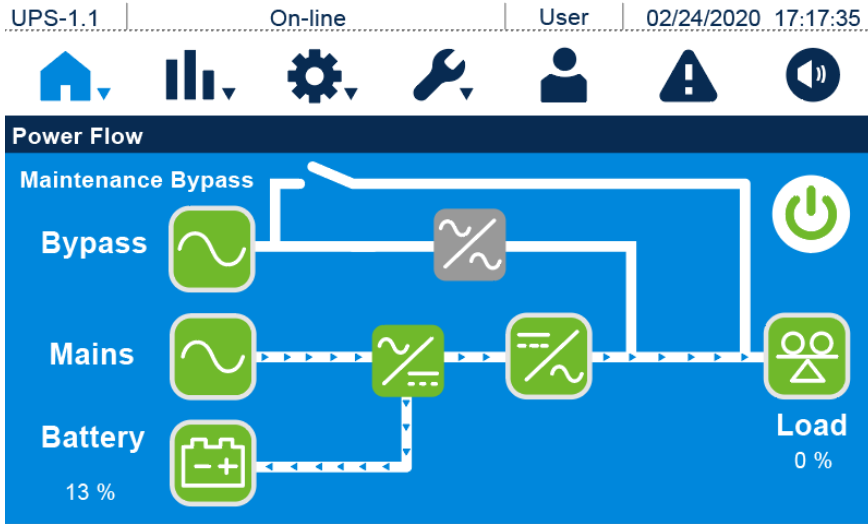

(Figure 6-26: Online Mode Screen)

2. Press the ON/ OFF button (🔌) once and the following screen will pop up to ask you if you want to power off the UPS's inverter. If yes, please select 'Power Off'.

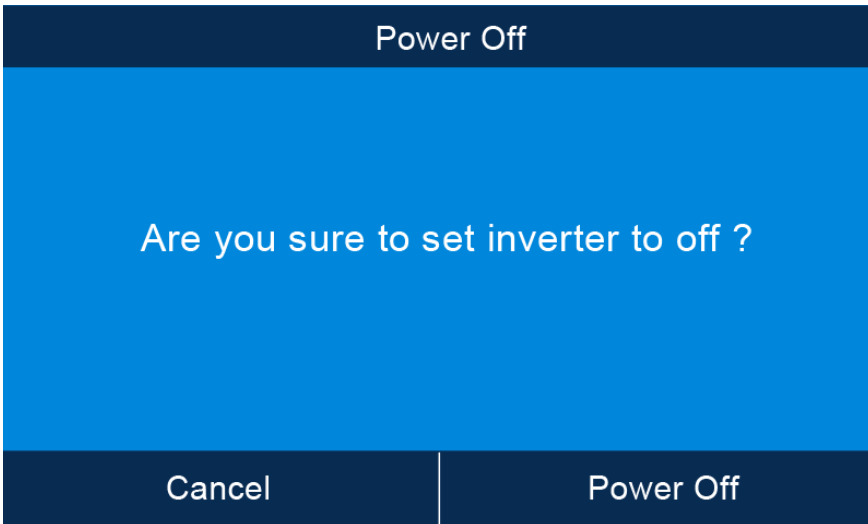

(Figure 6-27: Power Off Reminder Screen)

- After selection of 'Power Off', the UPS will shut down the inverter and let the bypass AC source supply power. If the bypass AC source is abnormal, there is a risk of output interruption and the connected critical loads won't be protected. At this moment, the UPS keeps charging the batteries, the tri-color LED indicator illuminates yellow and the following screen appears.

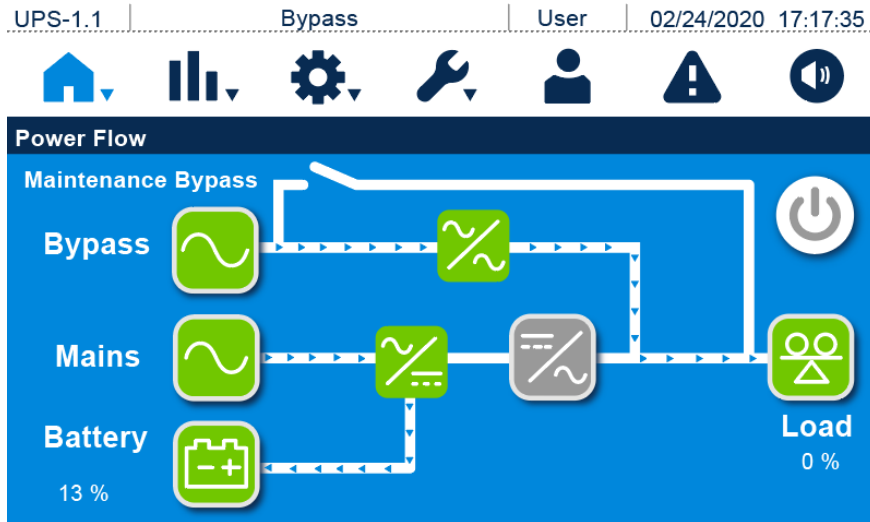

(Figure 6-28: Bypass Mode Screen)

- Single Input:** Switch **OFF** the bypass breaker, input breaker and output breaker.
Dual Input: Switch **OFF** the bypass breaker, input breaker and output breaker.
- The UPS will discharge DC bus voltage, and the tri-color LED indicator will illuminate yellow. After discharging is completed, the UPS will shut down, and the touch panel and the tri-color LED indicator will be off.
- Switch **OFF** every external battery cabinet's breaker.

6.3.2 Battery Mode Turn-off Procedures



WARNING:

- For parallel units, ensure that every operation procedure mentioned below is synchronized to all parallel UPSs.
- For parallel application, if you just want to operate a specific UPS but not all parallel ones, please contact Delta service personnel.

1. In battery mode, the touch panel shows the following screen and the tri-color LED indicator illuminates yellow.

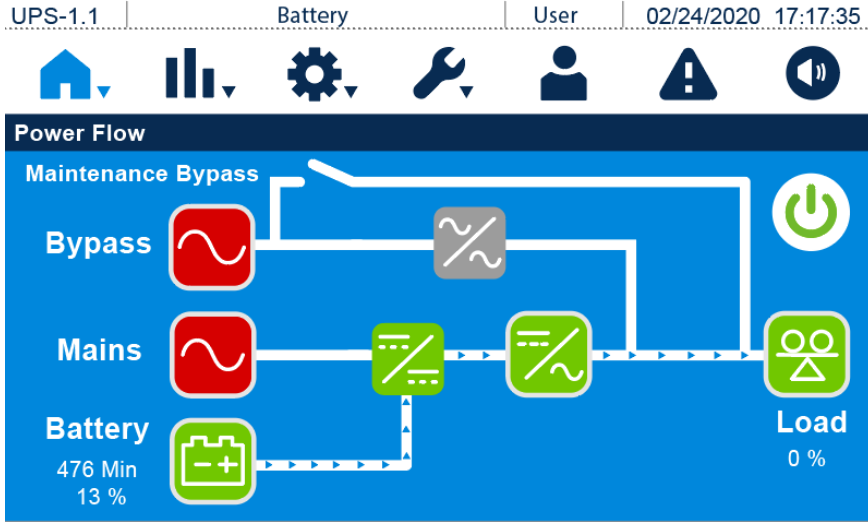

(Figure 6-29: Battery Mode Screen)

2. Press the ON/ OFF button () once and the following screen will pop up to ask you if you want to power off the UPS's inverter. If yes, please select 'Power Off'.

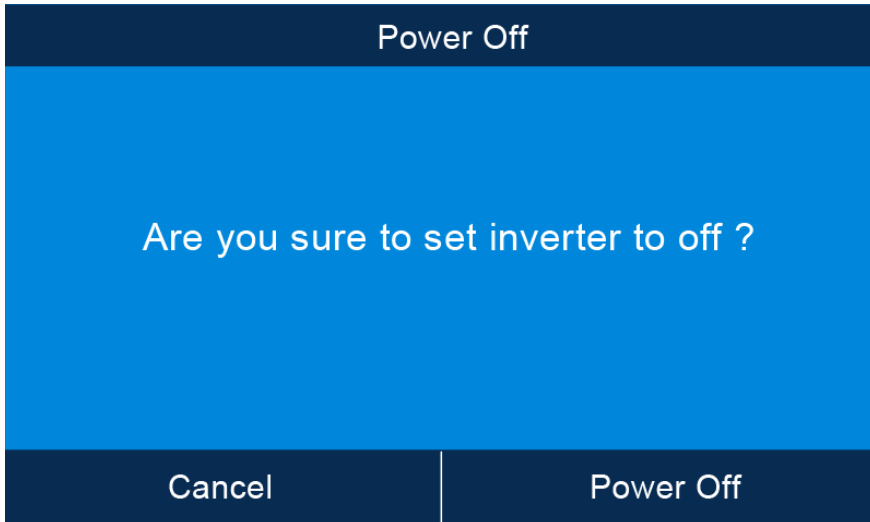

(Figure 6-30: Power Off Reminder Screen)

- After selection of 'Power Off', the UPS will shut down the inverter, terminate the output and transfer to run in standby mode. At this moment, the tri-color LED indicator illuminates yellow and the following screen appears.

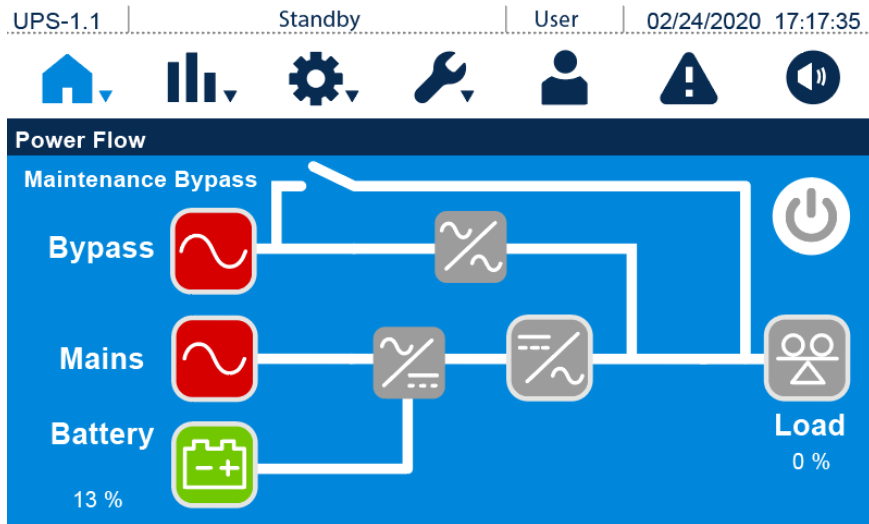

(Figure 6-31: Standby Mode Screen)

- Single Input:** Switch **OFF** the bypass breaker, input breaker and output breaker.
Dual Input: Switch **OFF** the bypass breaker, input breaker and output breaker.
- The UPS will discharge DC bus voltage, and the tri-color LED indicator will illuminate yellow. After discharging is completed, the UPS will shut down, and the touch panel and the tri-color LED indicator will be off.
- Switch **OFF** every external battery cabinet's breaker.

6.3.3 Bypass Mode Turn-off Procedures



WARNING:

- For parallel units, ensure that every operation procedure mentioned below is synchronized to all parallel UPSs.
- For parallel application, if you just want to operate a specific UPS but not all parallel ones, please contact Delta service personnel.

1. In bypass mode, the touch panel shows the following screen and the tri-color LED indicator illuminates yellow.

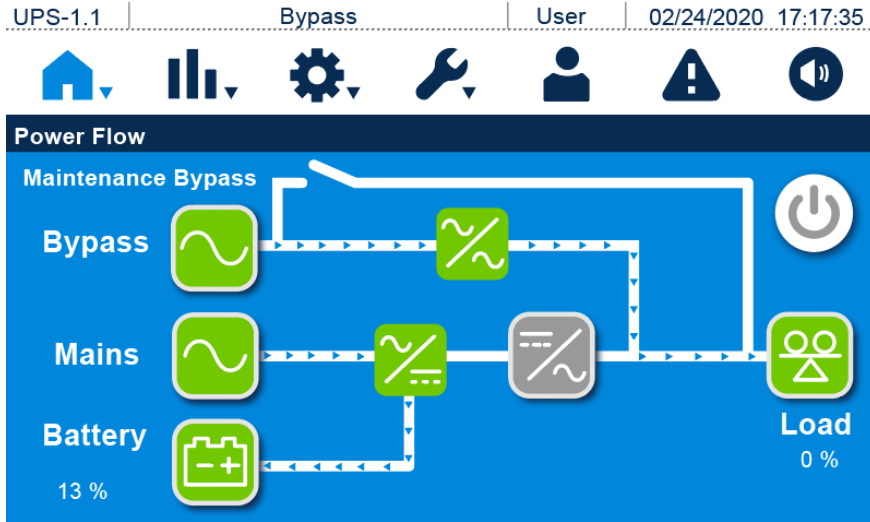

(Figure 6-32: Bypass Mode Screen)

2. **Single Input:** Switch **OFF** the bypass breaker, input breaker and output breaker.
Dual Input: Switch **OFF** the bypass breaker, input breaker and output breaker.
3. The UPS will discharge DC bus voltage, and the tri-color LED indicator will illuminate yellow. After discharging is completed, the UPS will shut down, and the touch panel and the tri-color LED indicator will be off.
4. Switch **OFF** every external battery cabinet's breaker.

6.3.4 Manual Bypass Mode Turn-off Procedures



WARNING:

1. For parallel units, ensure that every operation procedure mentioned below is synchronized to all parallel UPSs.
2. For parallel application, if you just want to operate a specific UPS but not all parallel ones, please contact Delta service personnel

In manual bypass mode, the touch panel and the tri-color LED indicator are both **OFF**. In either single input or dual input, please directly switch **OFF** the manual bypass breaker to completely shut down the UPS.



NOTE:

1. Please make sure that the touch panel, tri-color LED indicator and fans are **OFF**.
2. Please make sure that all switches, breakers, and power are **OFF**.

6.3.5 ECO Mode Turn-off Procedures



WARNING:

1. For parallel units, ensure that every operation procedure mentioned below is synchronized to all parallel UPSs.
2. For parallel application, if you just want to operate a specific UPS but not all parallel ones, please contact Delta service personnel.

1. In ECO mode, the touch panel shows the following screen and the tri-color LED indicator illuminates green.

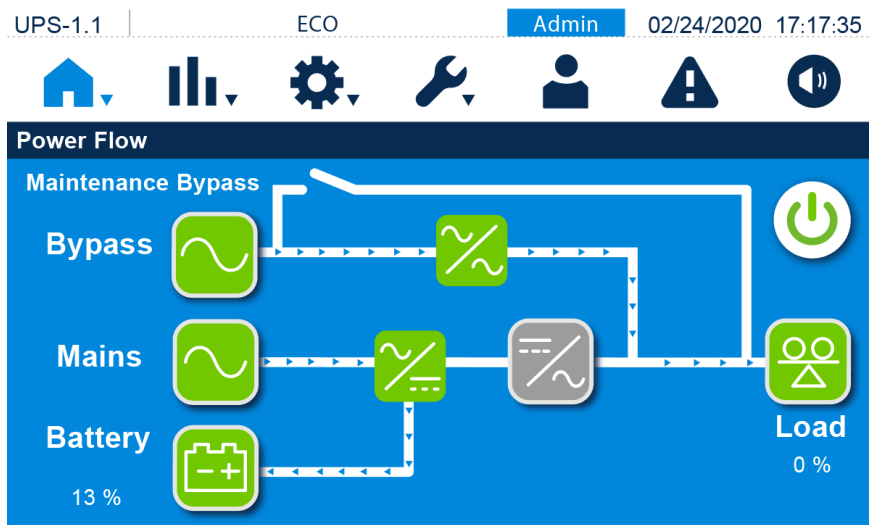

(Figure 6-33: ECO Mode Screen)

2. Press the ON/ OFF button () once and the following screen will pop up to ask you if you want to power off the UPS's inverter. If yes, please select 'Power Off'.

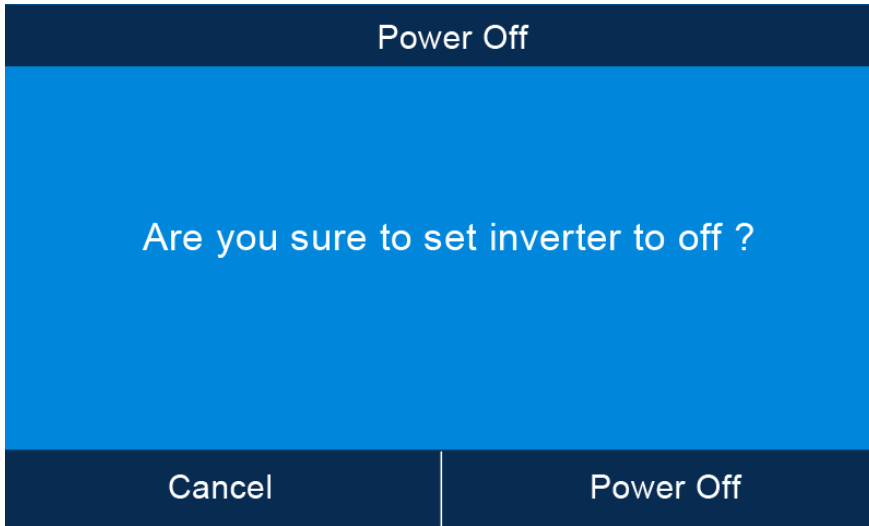

(Figure 6-34: Power Off Reminder Screen)

3. After selection of 'Power Off', the UPS will shut down the inverter, terminate the output and transfer to run in bypass mode. If the bypass AC source is abnormal, there is a risk of output interruption and the connected critical loads won't be protected. At this moment, the tri-color LED indicator illuminates yellow and the following screen appears.

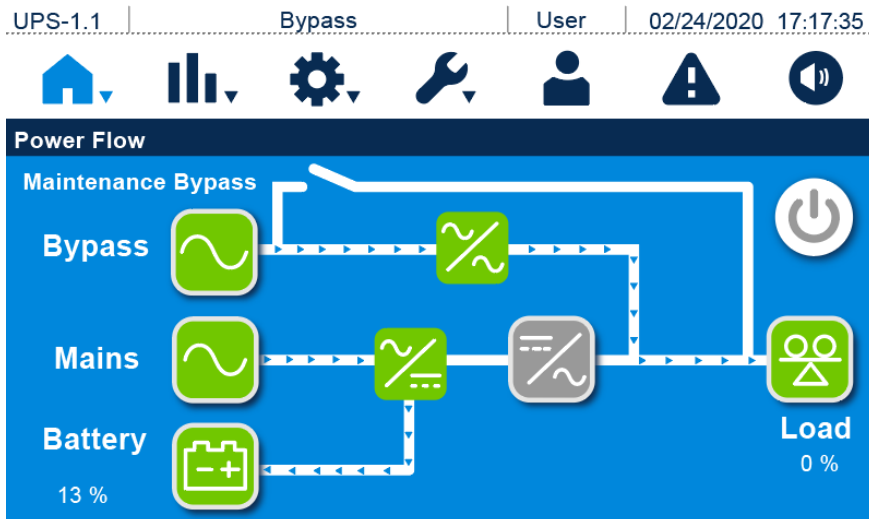

(Figure 6-35: Bypass Mode Screen)

- Please log in as an **Administrator**. For the **Administrator** password, please contact Delta service personnel. After login, ensure that you are in the **Administrator** login status.
- Click **SETUP** → **Mode Setting** → **On-Line**.

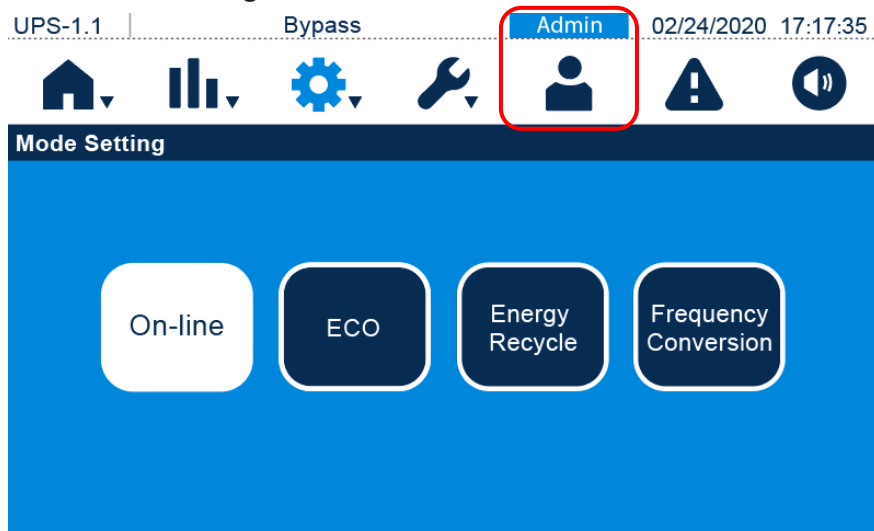

(Figure 6-36: Select On-Line Mode)

- Single Input:** Switch **OFF** the bypass breaker, input breaker and output breaker.
Dual Input: Switch **OFF** the bypass breaker, input breaker and output breaker.
- The UPS will discharge DC bus voltage, and the tri-color LED indicator will illuminate yellow. After discharging is completed, the UPS will shut down, and the touch panel and the tri-color LED indicator will be off.
- Switch **OFF** every external battery cabinet's breaker.

6.3.6 Frequency Conversion Mode Turn-off Procedures



WARNING:

- For parallel units, ensure that every operation procedure mentioned below is synchronized to all parallel UPSs.
- For parallel application, if you just want to operate a specific UPS but not all parallel ones, please contact Delta service personnel.

1. In frequency conversion mode, the touch panel shows the following screen and the tri-color LED indicator illuminates green.

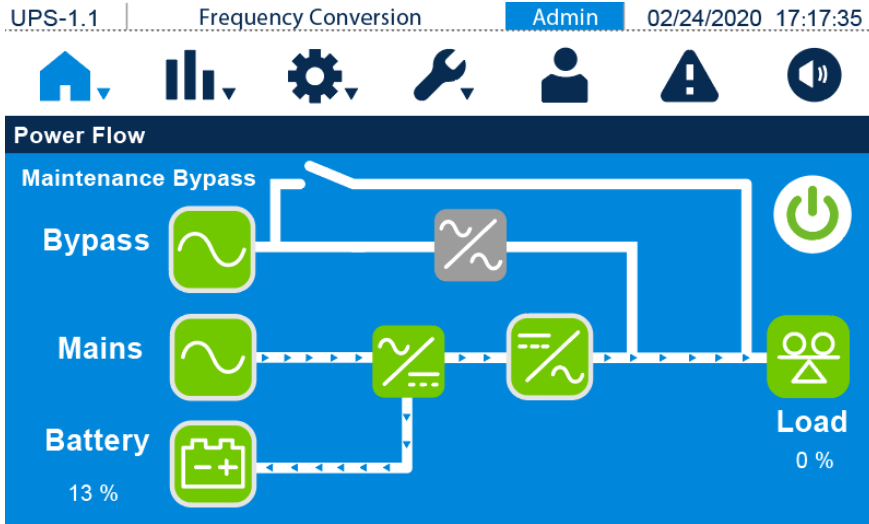

(Figure 6-37: Frequency Conversion Mode Screen)

2. Press the ON/ OFF button () once and the following screen will pop up to ask you if you want to power off the UPS's inverter. If yes, please select 'Power Off'.

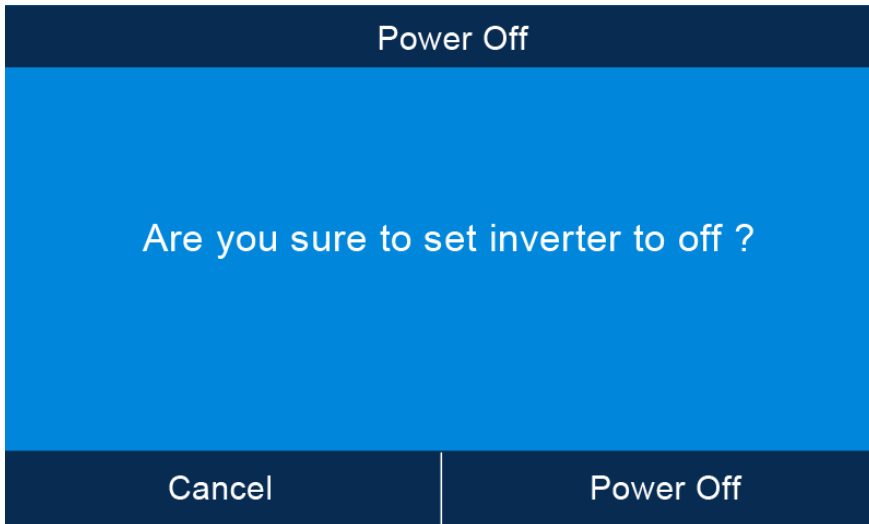

(Figure 6-38: Power Off Reminder Screen)



WARNING:

Please note that, once you select 'Power Off', all power will be completely cut off. Please make sure that the critical loads connected to the UPS have already been safely shut down before you perform the turn-off procedures.

- After selection of '**Power Off**', the UPS will shut down the inverter and terminate the output. As there is no bypass output in frequency conversion mode, all output will be terminated right after the inverter is shut down. Now, the UPS keeps charging the batteries, the tri-color LED indicator illuminates yellow and the following screen appears.

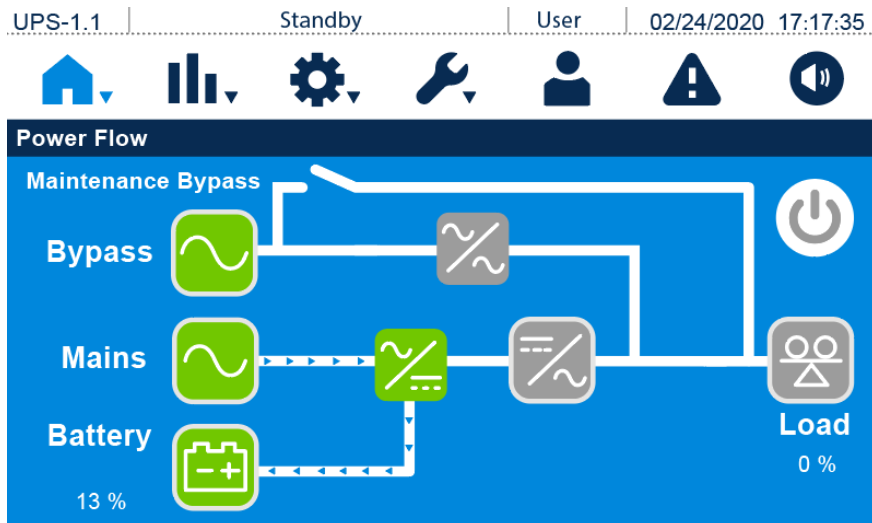

(Figure 6-39: Standby Mode Screen)

- Switch **OFF** output breaker and log in as an **Administrator**. For the **Administrator** password, please contact Delta service personnel. After login, ensure that you are in the **Administrator** login status.
- Click **SETUP** → **Mode Setting** → **On-Line**. If the bypass voltage is in the normal range, the UPS will run in bypass mode to let the bypass AC source supply power to the output.

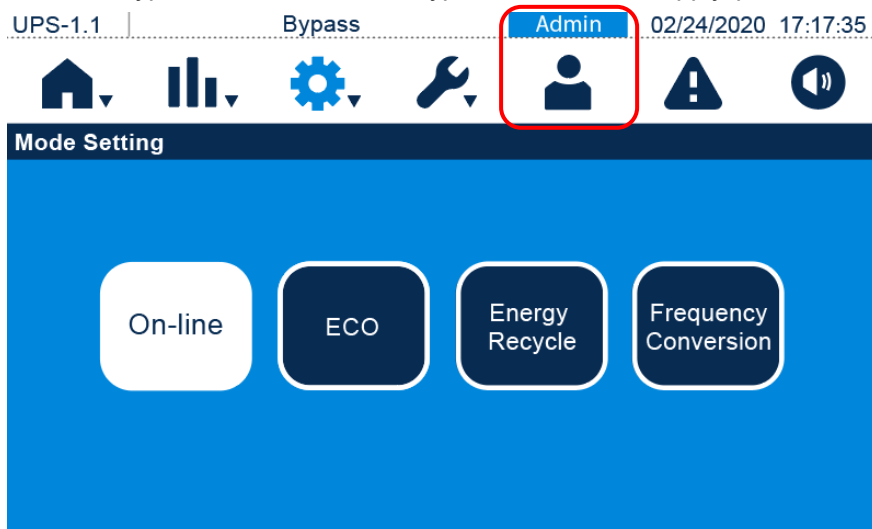

(Figure 6-40: Select On-Line Mode)

6. **Single Input:** Switch **OFF** the bypass breaker, input breaker and output breaker.
Dual Input: Switch **OFF** the bypass breaker, input breaker and output breaker.
7. The UPS will discharge DC bus voltage, and the tri-color LED indicator will illuminate yellow. After discharging is completed, the UPS will shut down, and the touch panel and the tri-color LED indicator will be off.
8. Switch **OFF** every external battery cabinet's breaker.

6.3.7 Energy Recycle Mode Turn-off Procedures



WARNING:

1. Energy mode is just for UPS self-loading test, and is only applicable for single unit single input. The output does not need to take any load.
 2. In energy recycle mode, the charger is turned off.
1. In energy recycle mode, the touch panel shows the following screen and the tri-color LED indicator illuminates green.

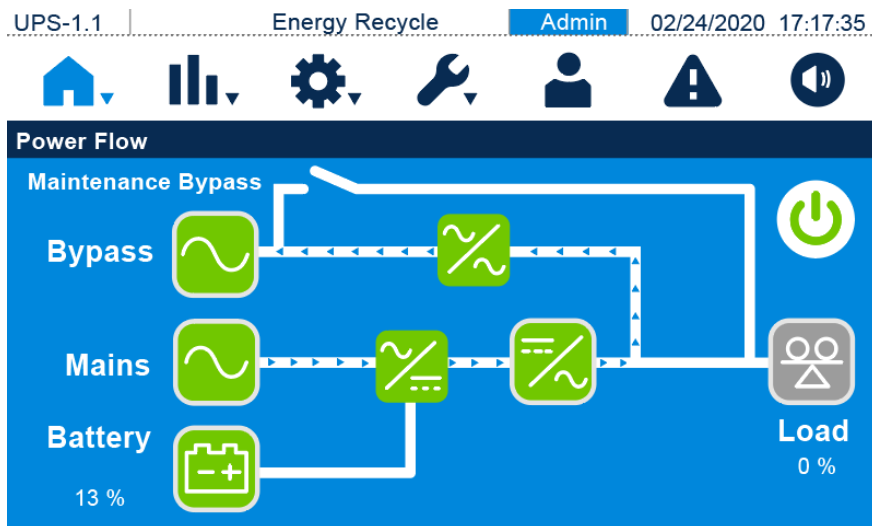

(Figure 6-41: Energy Recycle Mode Screen)

- Press the ON/ OFF button () once and the following screen will pop up to ask you if you want to power off the UPS's inverter. If yes, please select '**Power Off**'.

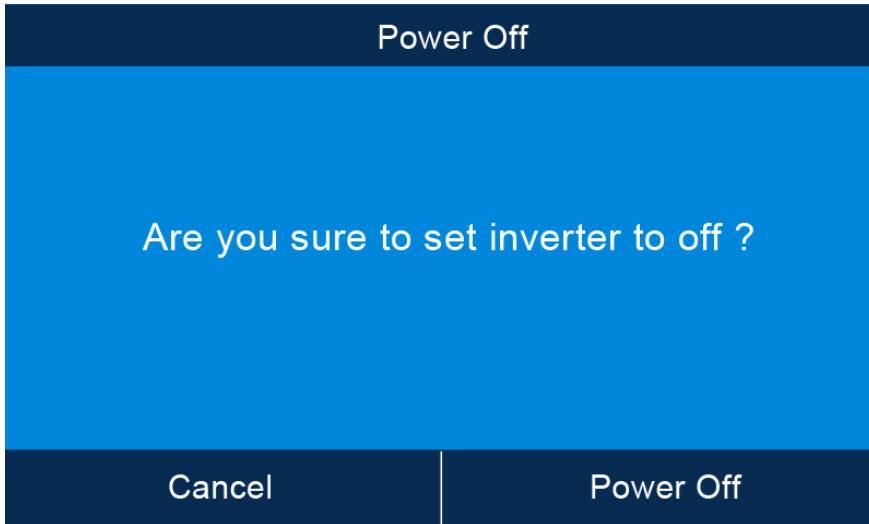

(Figure 6-42: Power Off Reminder Screen)

- After selection of '**Power Off**', the UPS will stop aging test, and run in bypass mode. At this moment, the tri-color LED indicator illuminates yellow and the following screen appears.

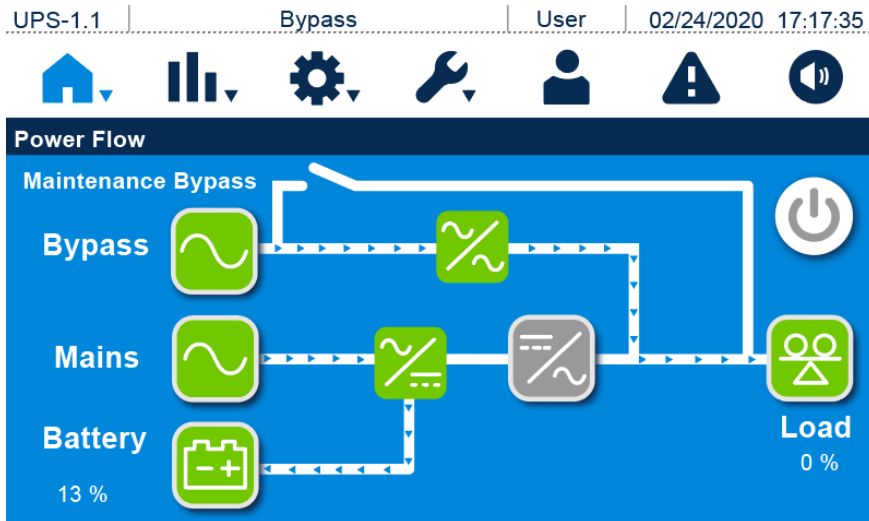

(Figure 6-43: Bypass Mode Screen)

- Switch **OFF** output breaker and log in as an **Administrator**. For the **Administrator** password, please contact Delta service personnel. After login, ensure that you are in the **Administrator** login status.

- Click **SETUP** → **Mode Setting** → **On-Line**. If the bypass voltage is in the normal range, the UPS will run in bypass mode to let the bypass AC source supply power to the output.

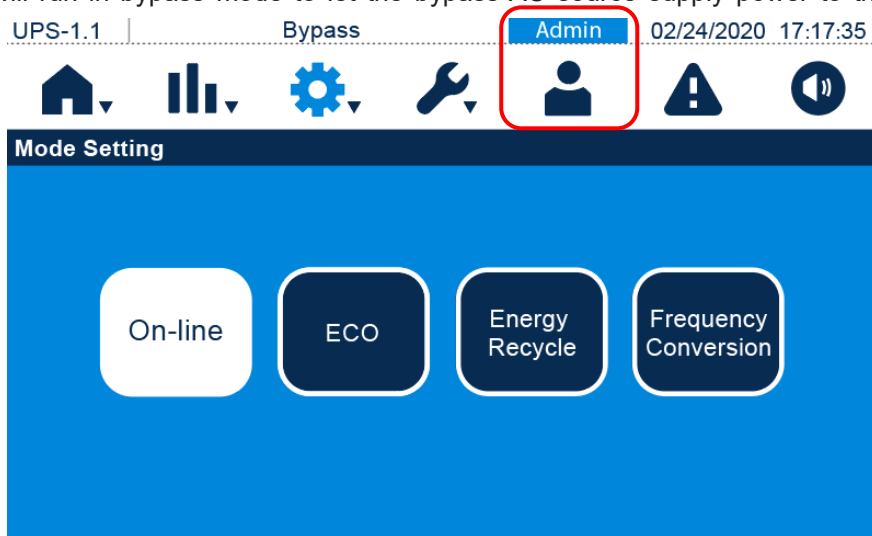

(Figure 6-44: Select On-Line Mode)

- Switch **OFF** the bypass breaker, input breaker and output breaker.
- The UPS will discharge DC bus voltage, and the tri-color LED indicator will illuminate yellow. After discharging is completed, the UPS will shut down, and the touch panel and the tri-color LED indicator will be off.
- Switch **OFF** every external battery cabinet's breaker.

Chapter 7: Touch Panel Display and Settings

7.1 Touch Panel Display Hierarchy

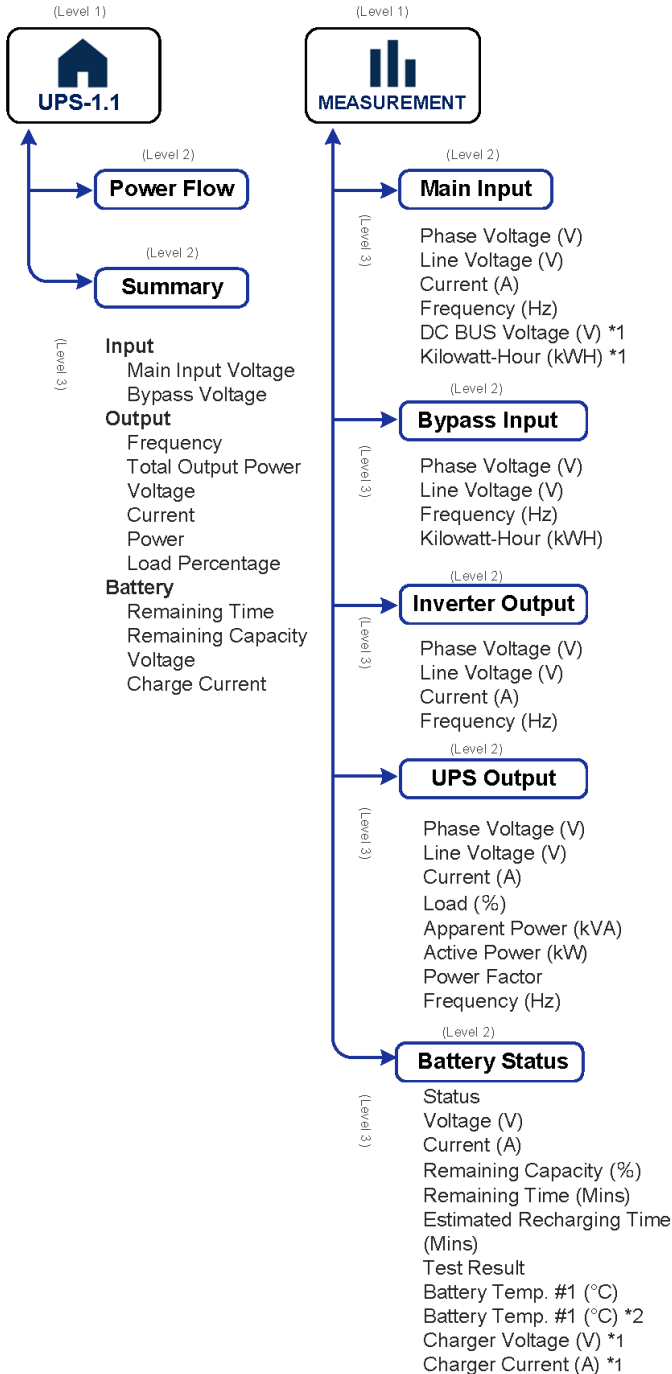

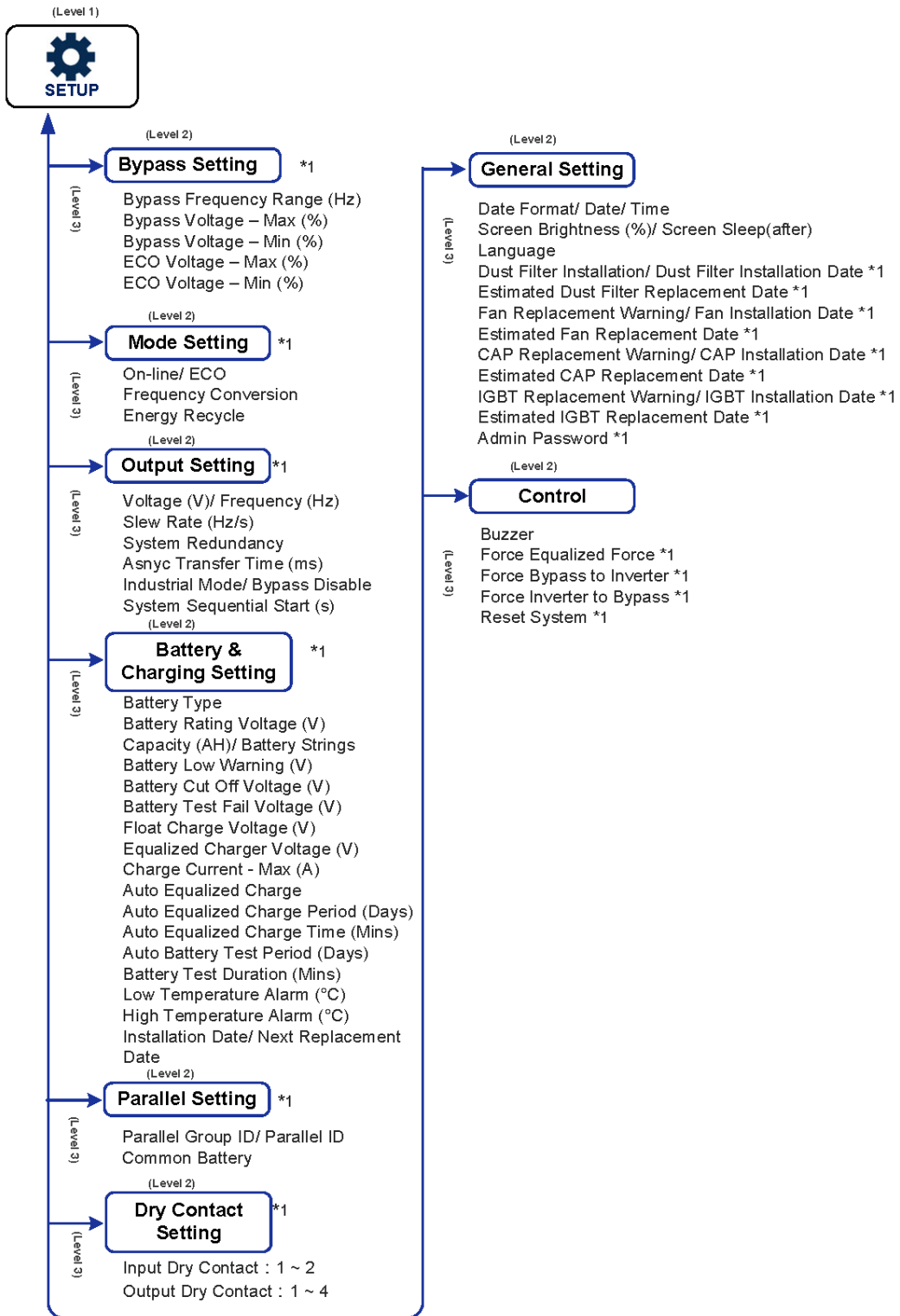

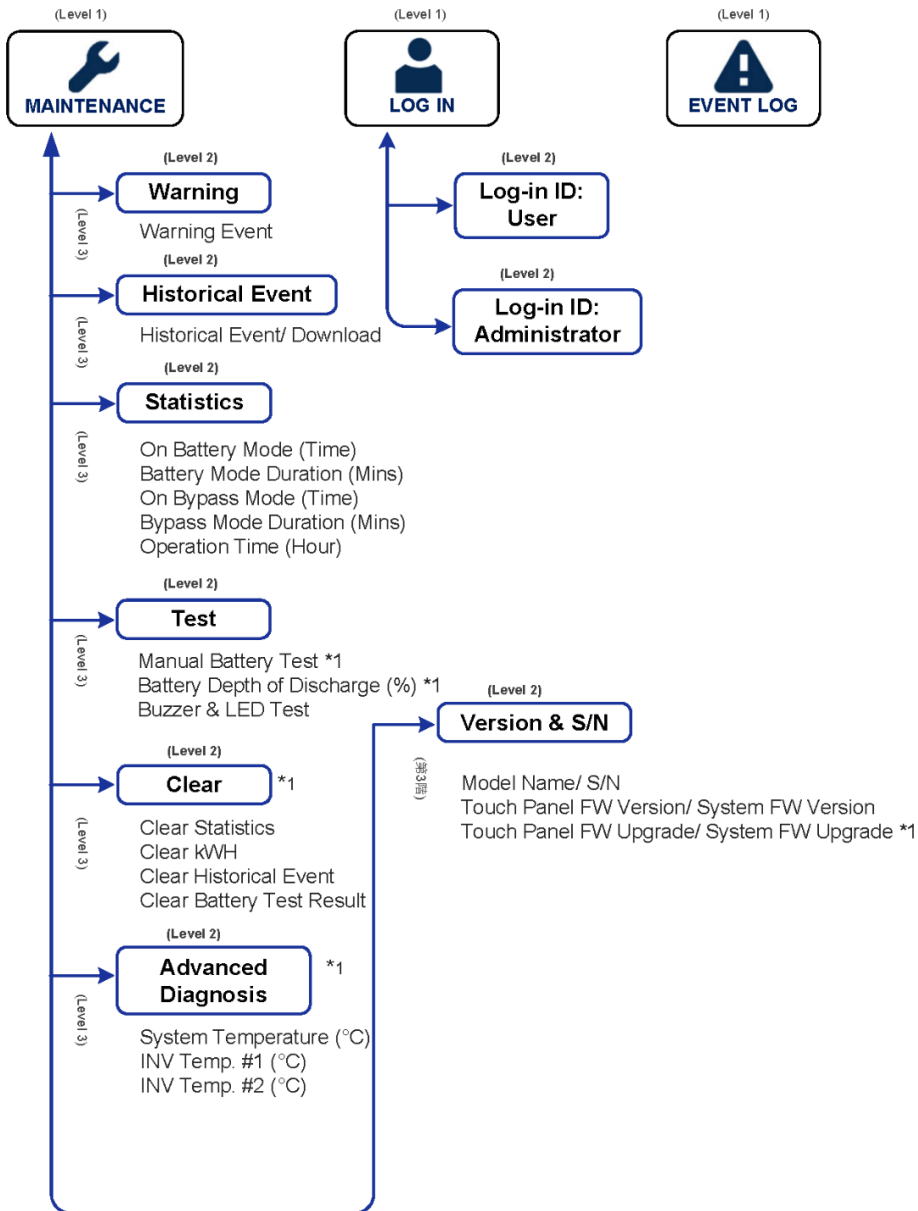

(Figure 7-1: Menu Tree)



NOTE:

1. *1 indicates that the **ADMINISTRATOR** password is needed. For password information, please refer to **7.5 Password Entry**.
2. The items marked with *1 need to be carried out by qualified service personnel, please contact Delta service personnel for assistance.
3. *2 reserved for inbuilt battery model.

7.2 Turn on the touch panel



NOTE: Confirm the AC mains is normal before turning on the touch panel.

1. Please refer to the following steps to turn on the touch panel.
 - a. Switch **ON** the bypass breaker, the touch panel will then light up; or
 - b. Switch **ON** the input breaker, the touch panel will then light up; or
 - c. Switch **ON** the external battery cabinet's breaker, and press the battery start button on the rear panel of the UPS for 3 seconds and release it after you hear one beep, the touch panel will then light up.
2. About 25 seconds after the touch panel lights up, the main screen will appear as follows. And now, the touch panel can be used. Please note that when the main screen is shown, the login account is **User**.

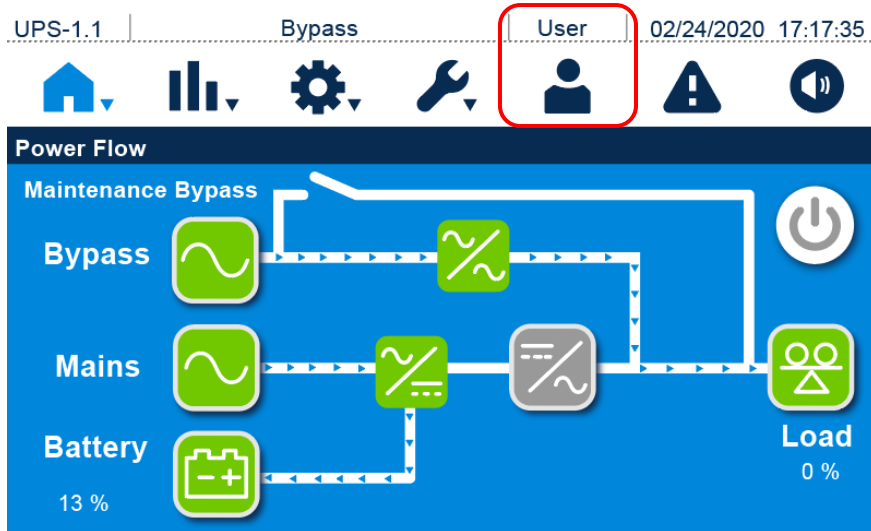

(Figure 7-2: Main Screen_User Login)

7.3 ON/ OFF Button

When the main screen appears, the ON/ OFF Button (⏻) will appear at the same time.

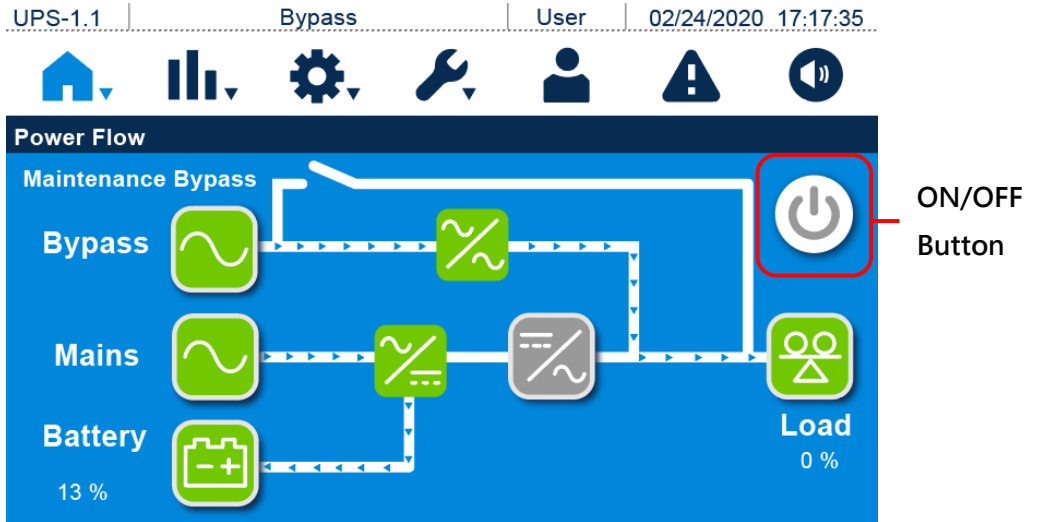

(Figure 7-3: ON/ OFF Button Location)

- **Power On**

When the ON/ OFF button is gray (⏻), it indicates that the UPS's inverter is in the **OFF** status. Press the button once, the following reminder window will pop up to ask you if you want to power on the UPS's inverter. If yes, please select '**Power On**'.

After selecting '**Power On**', the ON/ OFF button will turn green (⏻), indicating that the UPS is starting up or the power-on process is completed.

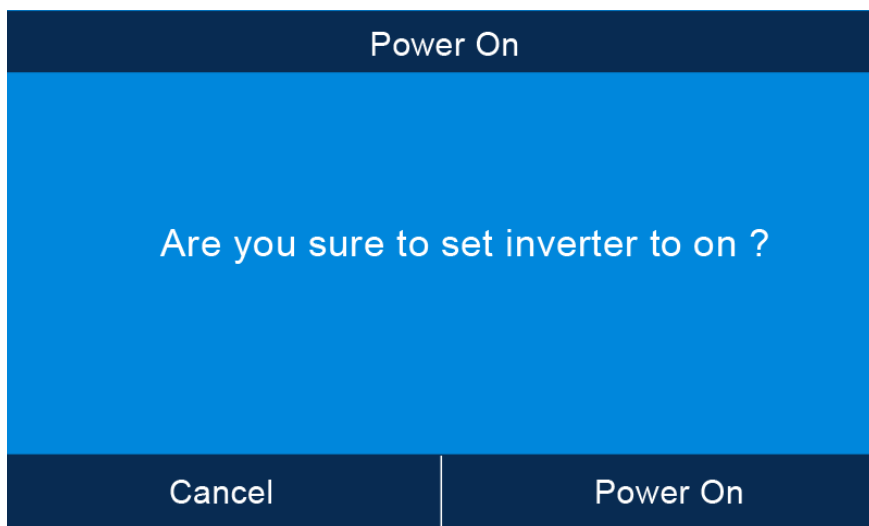

(Figure 7-4: Power On Reminder Window)

- **Power Off**

When the ON/ OFF button is green (🔌), it indicates that the UPS's inverter is in the **ON** status. Press the button once and the following reminder window will pop up to ask you if you want to power off the UPS's inverter. If yes, please select '**Power Off**'.

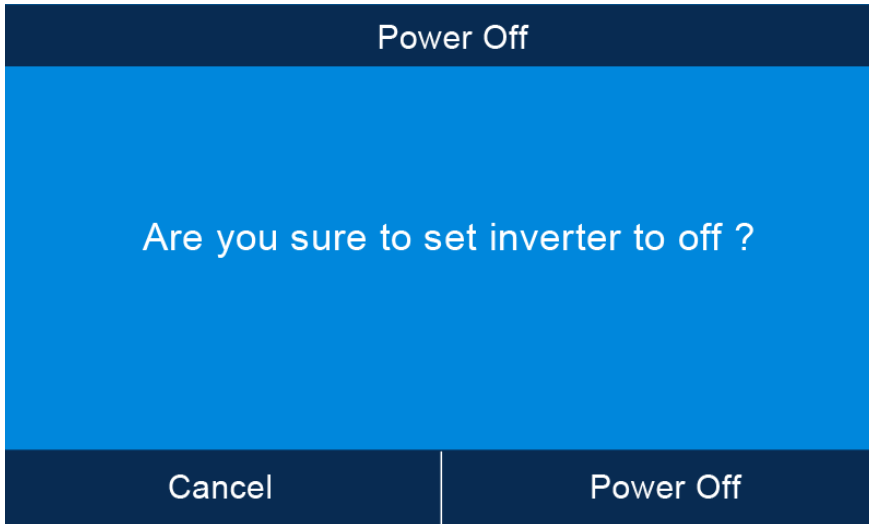

After selecting '**Power Off**', the ON/ OFF button will turn gray (🔌), indicating that the power-off process is completed.





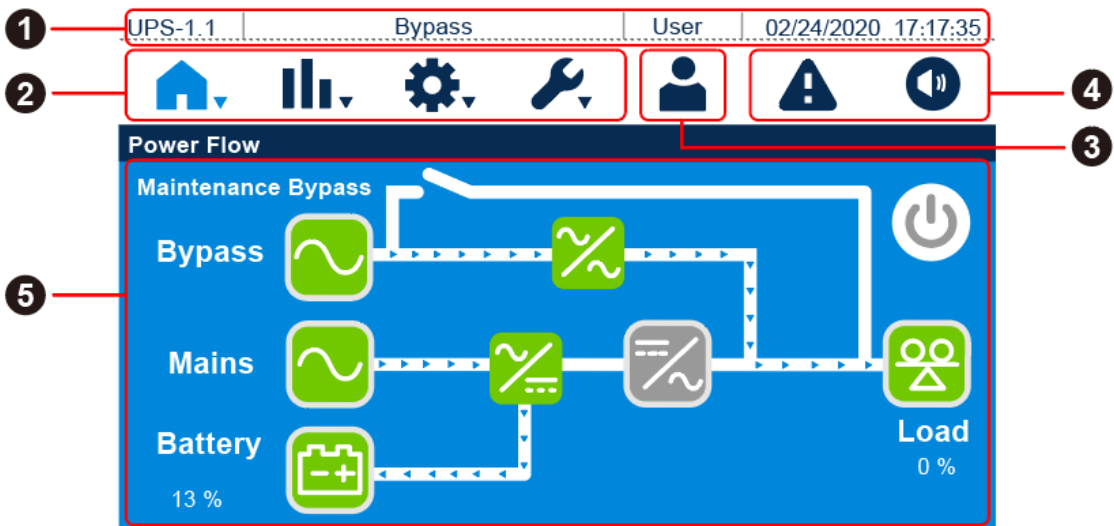











(Figure 7-5: Power Off Reminder Window)

7.4 Introduction of Touch Panel and Function Keys





No.	Icon/ Text	Button Function (Yes or No)	Description
1	UPS-1.1		<p>The UPS-1.1 indicates the group ID and parallel ID of the UPS.</p> <p> NOTE: For parallel UPSs (at maximum four), (M) & (S) will appears behind each parallel UPS's parallel ID No. and parallel group No. The UPS with (M) is master unit, and the one with (S) is slave unit.</p>
	On-Line Mode Battery Mode Bypass Mode Standby Mode Softstart Mode Fault Mode Remote Mode Energy Recycle Mode ECO Mode Frequency Conversion Mode		Indicates the operation status of the UPS. The actual display will depend on the actual operation status
	User		Indicates login by User .
	Administrator		Indicates login by Administrator .
	02/24/2020 17:17:35		Indicates the date and time.
	2		Yes
		Yes	Shortcut button for the measurement menu. For more information, please refer to 7.8 Measurement .

No.	Icon/ Text	Button Function (Yes or No)	Description
		Yes	Shortcut button for the setup menu. For more information, please refer to 7.9 Setup .
		Yes	Shortcut button for the maintenance menu. For more information, please refer to 7.10 Maintenance .
3		Yes	Indicates login by User or Administrator . The button can be pressed to change the login permission. For more information, please refer to 7.5 Password Entry .
4		Yes	Warning event shortcut button () The numerical value at the upper right of the warning icon indicates the number of current warning events. You can press the icon to check the exact warning information.
		Yes	1. Buzzer button. 2. If any warning event occurs, the buzzer will sound. By clicking the buzzer button, the buzzer will be muted. At this time, the buzzer disabled symbol () will appear.
5			ON/OFF button. For more information, please refer to 7.3 ON/OFF Button .
			1. Bypass input status (green: normal; red: abnormal). 2. Bypass input screen shortcut button.
			1. Main input status (green: normal; red: abnormal). 2. Main input screen shortcut button.

No.	Icon/ Text	Button Function (Yes or No)	Description
			<ol style="list-style-type: none"> Battery status (green: normal; gray-green flashing: discharge; red: abnormal). Battery remaining capacity (%). Battery remaining time (Min). Battery status screen shortcut button.
			Bypass static switch status (green: ON; gray: OFF)
			Rectifier status (green: normal; gray: waiting or OFF).
			<ol style="list-style-type: none"> Inverter status (green: normal; gray: waiting or OFF). Inverter output screen shortcut button.
			<ol style="list-style-type: none"> Output status (green: normal; gray: no output). Load capacity (%) Output screen shortcut button.

Other symbols which will appear during the operation of the touch panel are shown in the table below:



No.	Symbol	Function
1		Up
2		Down
3		Delete



NOTE:

1. After the back light of touch panel is off, the user can gently touch the touch panel to back to the **Main Screen**. For information about the **Main Screen**, please refer to **7.6 Main Screen**.
2. The sleep time for the back light can be adjusted. Please refer to **7.9.7 General Setting**.
3. The default language is English. If the language needs to be changed, please click  → **General Setting** → **Language** to change the displayed language of the screen. The default language will be different in different countries.

7.5 Password Entry

1. Password entry is only required for login as an **Administrator**. **User** login does not require any password.
2. Click () → enter the **Administrator** password (please contact Delta service personnel for the password) → the 'Admin' appears at the top edge of the screen, indicating **Administrator** login is successful.
3. To change the **Administrator** password, click () → **General Setting** → **Admin Password** → change the **Administrator Password** (4 digits).
4. After finishing the settings, click () to log out and be back to the main screen in the **User** login status. Or, if idling for a moment until the back light of touch panel is off, the administrator account will log out automatically. And then touch the screen and it will be back to the main screen in **User** login status.

If idling the screen for one minute or the back light of the screen is off, the administrator account will log out automatically. And then touch the screen and it will be back to the main screen in **User** login status.



NOTE:

Different login IDs (Administrator/ User) have different access to different screens, inspection items and setup items. Please refer to **7.1 Touch Panel Display Hierarchy**.

7.6 Main Screen

1. Please refer to **7.2 Turn on the Touch Panel** and **7.3 ON/ OFF Button** for starting up the **Main Screen**.

2. The UPS will show different power flow screens depending on the actual status of the UPS. Each power flow screen is a **Main Screen**. See the examples below.

A. The screen below indicates that the UPS is in online mode and the loads are supplied by the inverter. About how to set up online mode, please refer to **7.9.2 Mode Setting** and **6.2.1 Online Mode Start-up Procedures**.

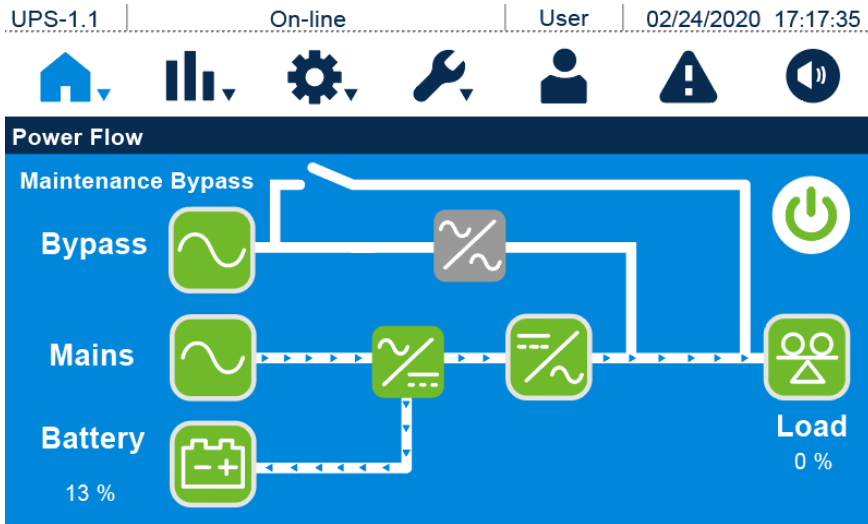

B. The screen below indicates that the UPS is in standby mode. The inverter is not turned on and the bypass is out of range.

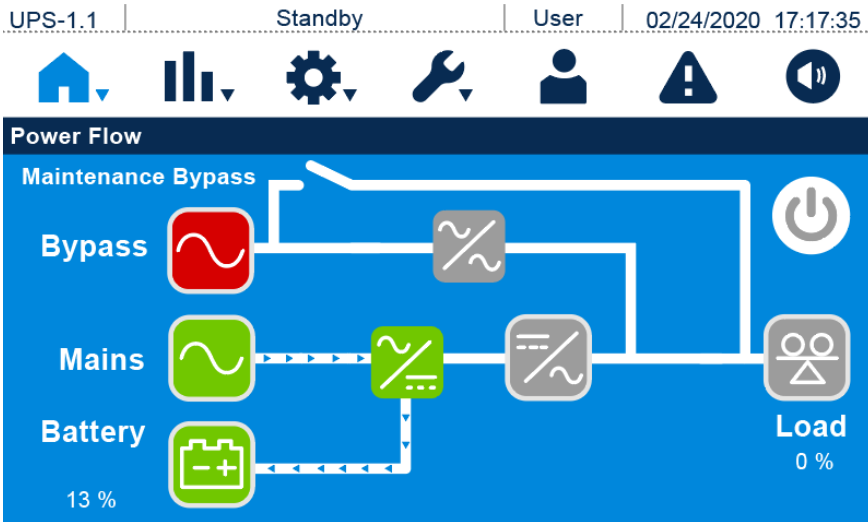

- C. The screen below indicates that the UPS is in ECO mode. The inverter is in the ready-to-power-on status, and the loads are supplied by the bypass power. About how to set up ECO mode, please refer to **7.9.2 Mode Setting** and **6.2.5 ECO Mode Start-up Procedures**.

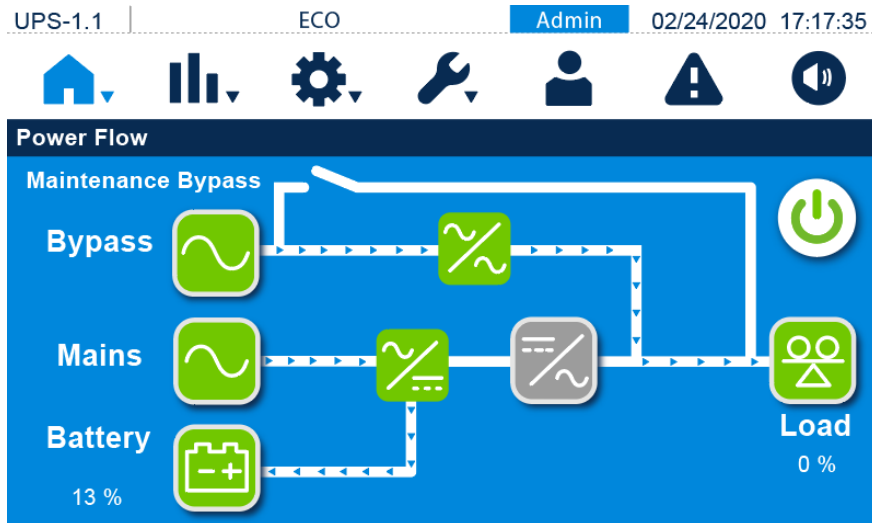

- D. The screen below indicates that the UPS is in battery mode.

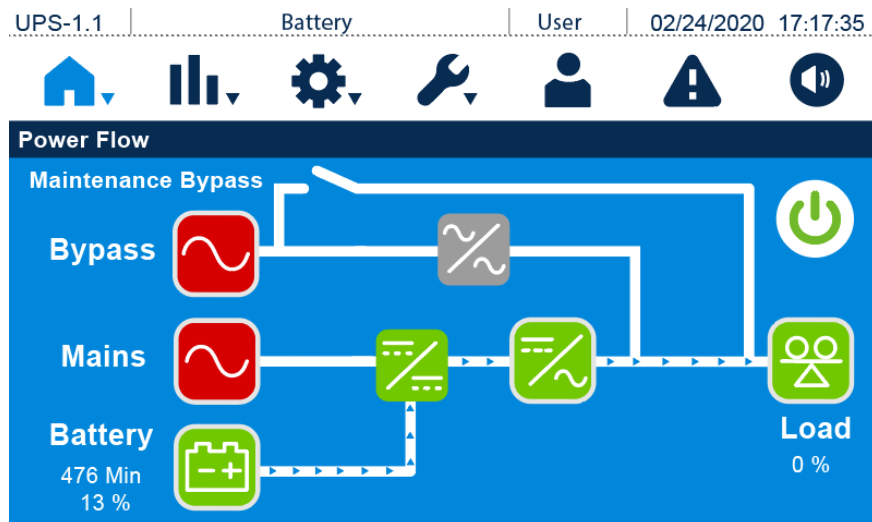

E. The screen below indicates that the UPS is in Bypass mode and the inverter is not turned on.

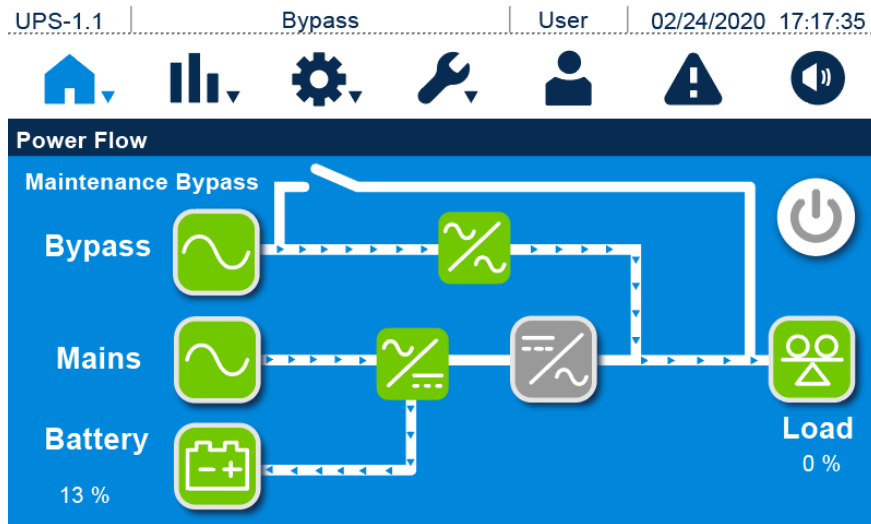

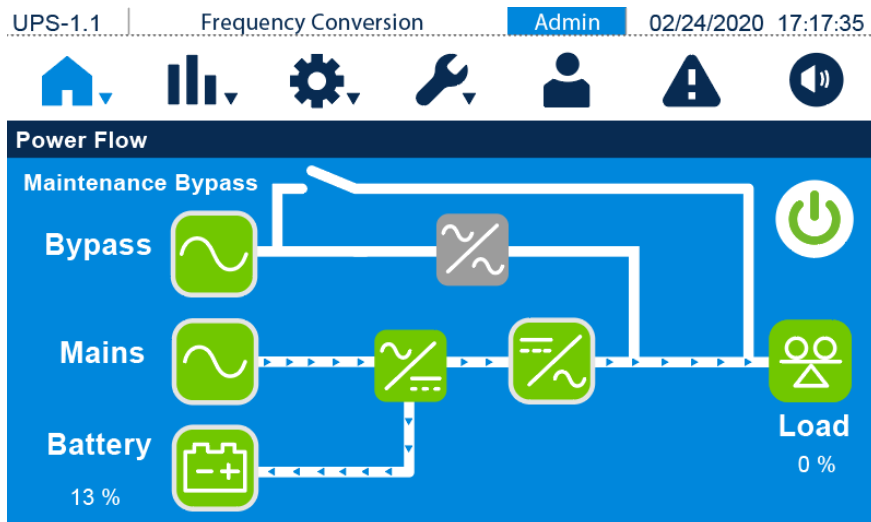

F. The screen below indicates that the UPS is in frequency conversion mode and the bypass output is restricted. About how to set up frequency conversion mode, please refer to **7.9.2 Mode Setting** and **6.2.6 Frequency Conversion Mode Start-up Procedures**.



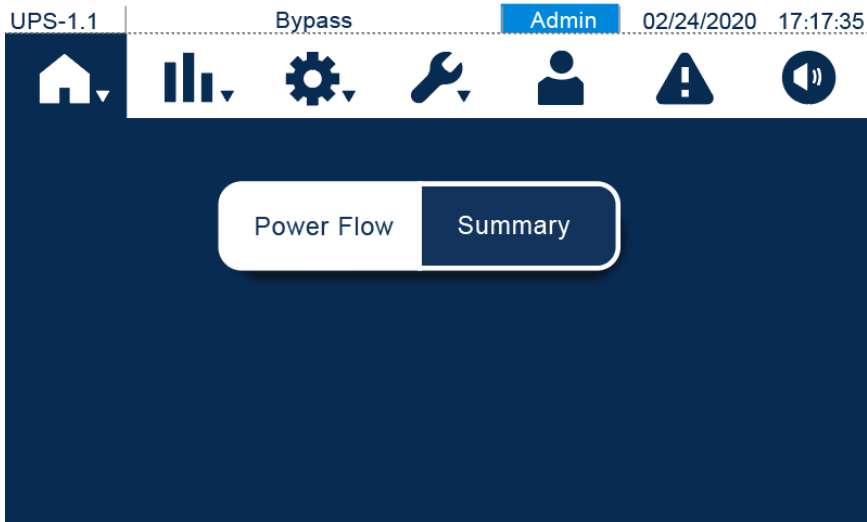

7.7 Power Flow & Summary

There are two shortcut buttons for you to check the **Power Flow** and **Summary** respectively. Please see the figure below.

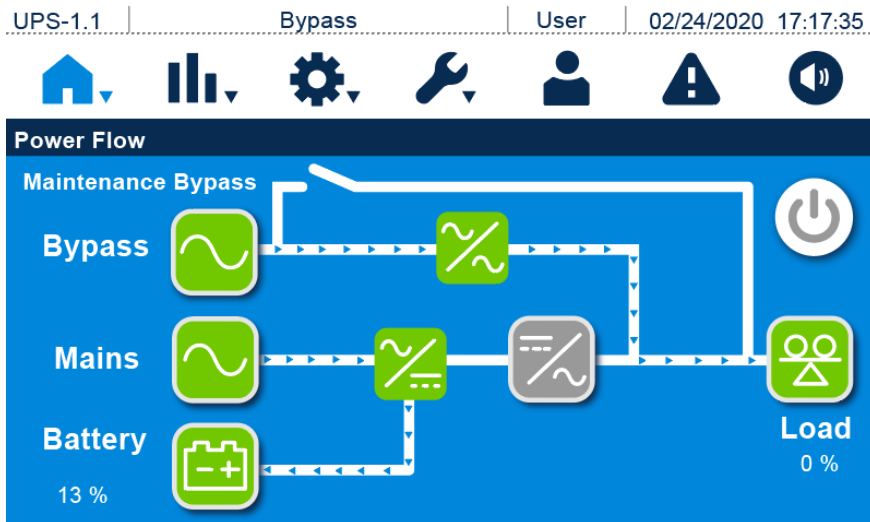

Press the Power Flow button () to check the UPS's power flow diagram, shown in the figure below.



Press the Summary button () to check information related to input, output and battery, shown in the figure below.

- Input information includes **Main Voltage** and **Bypass Voltage**.

UPS-1.1 | Bypass | Admin | 02/24/2020 17:17:35

Summary

Input

Main Voltage	Bypass Voltage
230.0 V	230.0 V
230.0 V	230.0 V
230.0 V	230.0 V

1/3

- Output information includes **Frequency**, **Total Output Power**, **Voltage**, **Current**, **Power** and **Load**.

UPS-1.1 | Bypass | Admin | 02/24/2020 17:17:35

Summary

Output

Frequency		50.0 Hz	
Total Output Power		0.0 kW	
Voltage	Current	Power	Load
230.0 V	0.0 A	0.0 kW	0.0 %
230.0 V	0.0 A	0.0 kW	0.0 %
230.0 V	0.0 A	0.0 kW	0.0 %

2/3

3. Battery information includes **Remaining Capacity**, **Remaining Time**, **Voltage** and **Current**.

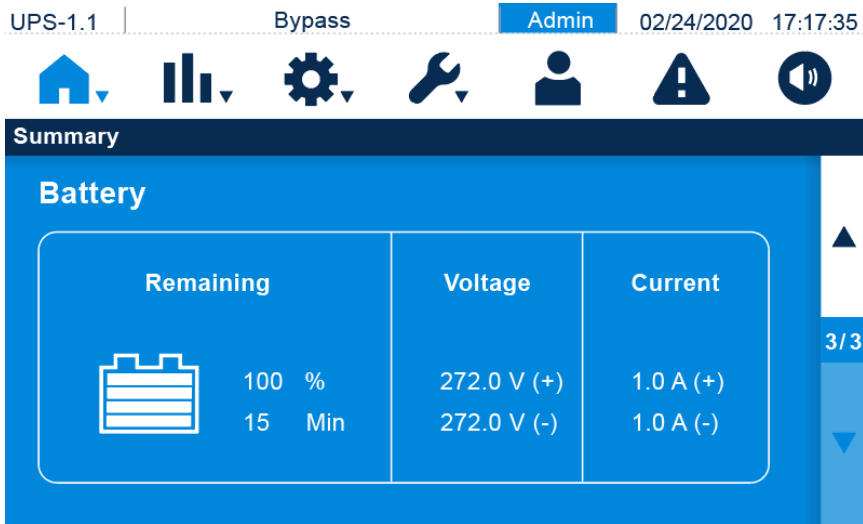

7.8 Measurement

There are five shortcut buttons for you to check the **Main Input**, **Bypass Input**, **Inverter Output**, **UPS Output** and **Battery Status** respectively. Please see the figure below.

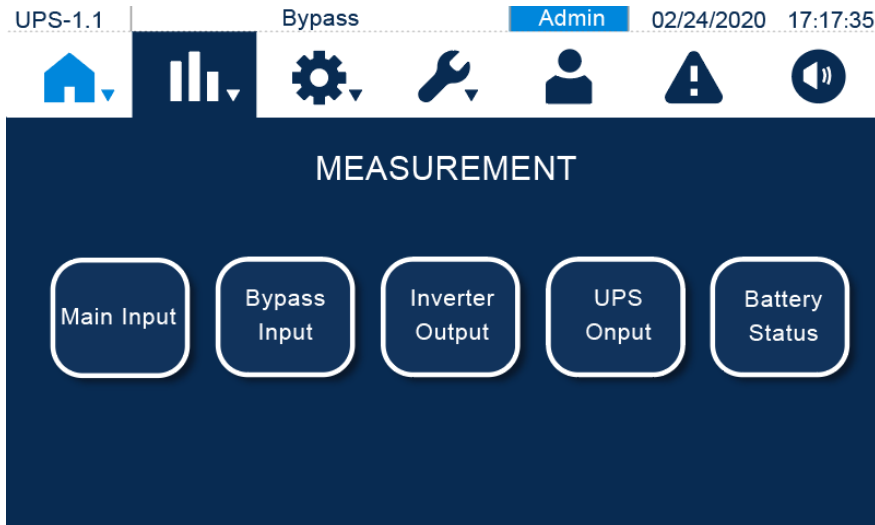

7.8.1 Main Input

In the **Main Input** screen, you can inquire about the **Phase Voltage**, **Line Voltage**, **Current**, **Frequency**, **DC BUS Voltage** and **Kilowatt-Hour** readings.

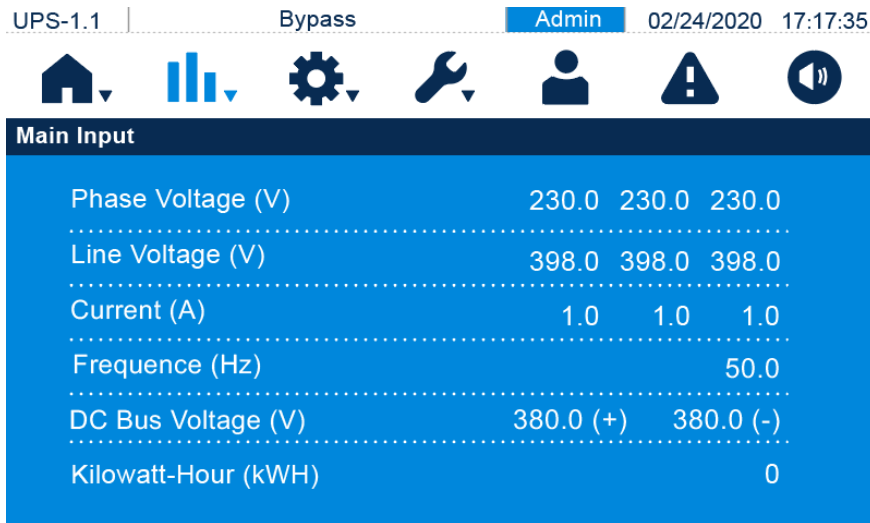

7.8.2 Bypass Input

In the **Bypass Input** screen, you can inquire about the **Phase Voltage**, **Line Voltage**, **Frequency** and **Kilowatt-Hour** readings.

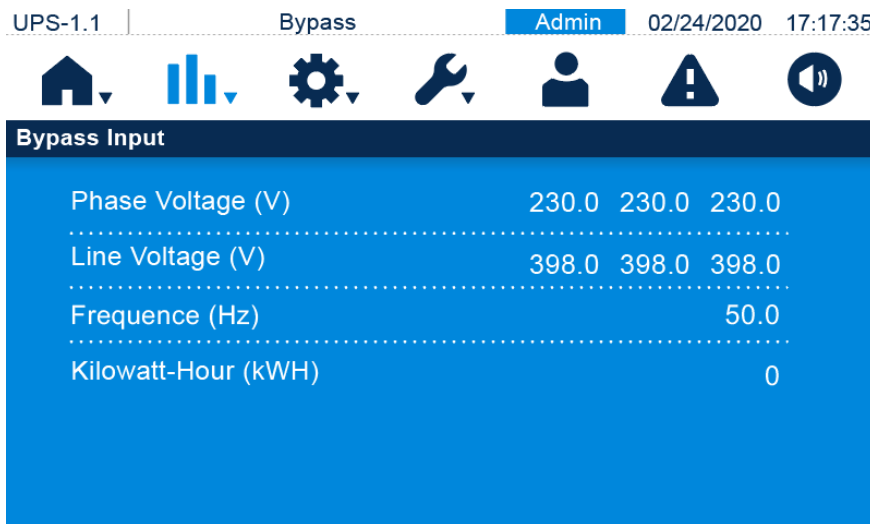

7.8.3 Inverter Output

In the **Inverter Output** screen, you can inquire about the **Phase Voltage**, **Line Voltage**, **Current** and **Frequency** readings.

UPS-1.1 | Bypass | Admin | 02/24/2020 | 17:17:35

Home | Bar Chart | Gear | Wrench | User | Alert | Speaker

Inverter Output

Phase Voltage (V)	230.0	230.0	230.0
Line Voltage (V)	398.0	398.0	398.0
Current (A)	1.0	1.0	1.0
Frequency (Hz)			50.0

7.8.4 UPS Output

In the **UPS Output** screen, you can inquire about the **Phase Voltage**, **Line Voltage**, **Current**, **Load**, **Apparent Power**, **Active Power**, **Power Factor** and **Frequency** readings.

UPS-1.1 | Bypass | Admin | 02/24/2020 | 17:17:35

Home | Bar Chart | Gear | Wrench | User | Alert | Speaker

UPS Output

Phase Voltage (V)	230.0	230.0	230.0
Line Voltage (V)	398.0	398.0	398.0
Current (A)	1.0	1.0	1.0
Load (%)	0	0	0
Apparent Power (kVA)	0.0	0.0	0.0
Active Power (kW)	0.0	0.0	0.0

1/2

UPS-1.1 | Bypass | Admin | 02/24/2020 17:17:35

Home | Bar Chart | Gear | Wrench | User | Warning | Speaker

UPS Output

Power Factor	0.0	0.0	0.0
Frequency (Hz)			50.0

2 / 2

7.8.5 Battery Status

In the **Battery Status** screen, you can inquire about the **Status**, **Voltage**, **Current**, **Remaining Capacity**, **Remaining Time**, **Estimated Recharging Time**, **Test Result**, **Battery Temp.**, **Charger Voltage** and **Charger Current** readings.

UPS-1.1 | Bypass | Admin | 02/24/2020 17:17:35

Home | Bar Chart | Gear | Wrench | User | Warning | Speaker

Battery Status

Status	Float Charge	
Voltage (V)	270.0 (+)	270.0 (-)
Current (A)	1.0 (+)	1.0 (-)
Remaining Capacity (%)	97	
Remaining Time (Mins)	15	
Estimated Recharging Time (Mins)	50	

1 / 2

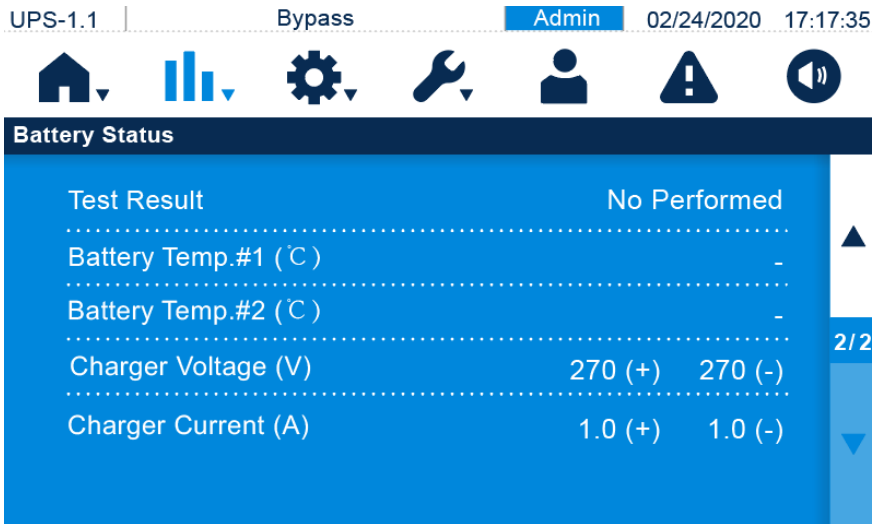

7.9 Setup

There are eight shortcut buttons for you to set up the **Bypass Setting**, **Mode Setting**, **Output Setting**, **Battery and Charging Setting**, **Parallel Setting**, **Dry Contact Setting**, **General Setting** and **Control** respectively. Please see the figure below.

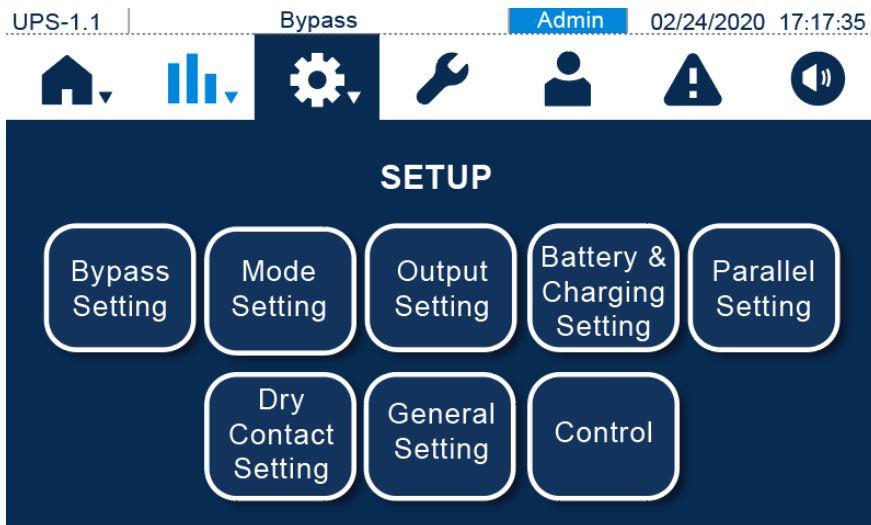

7.9.1 Bypass Setting

In the **Bypass Setting** screen, the administrator can set up the **Bypass Frequency Range**, **Bypass Voltage - Max**, **Bypass Voltage - Min**, **ECO Voltage - Max** and **ECO Voltage - Min**. If the range is exceeded, the system will issue an alarm. These settings must be performed by qualified service personnel, please contact Delta service personnel for assistance.

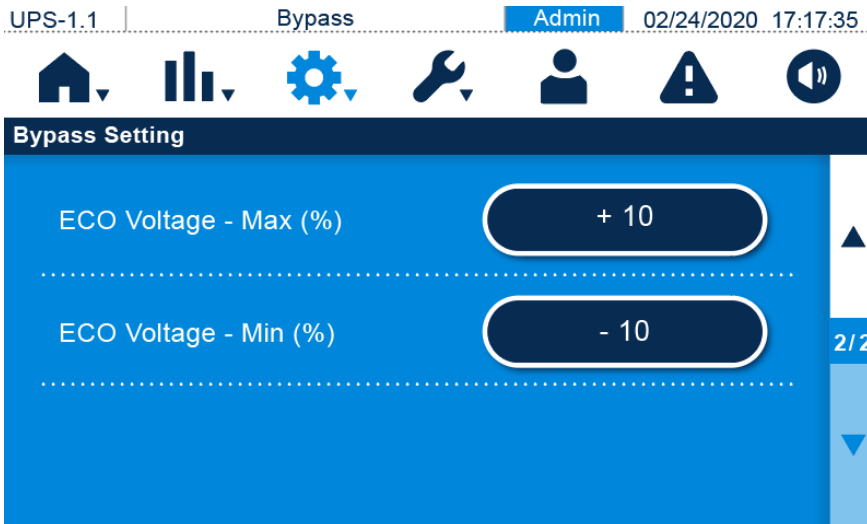
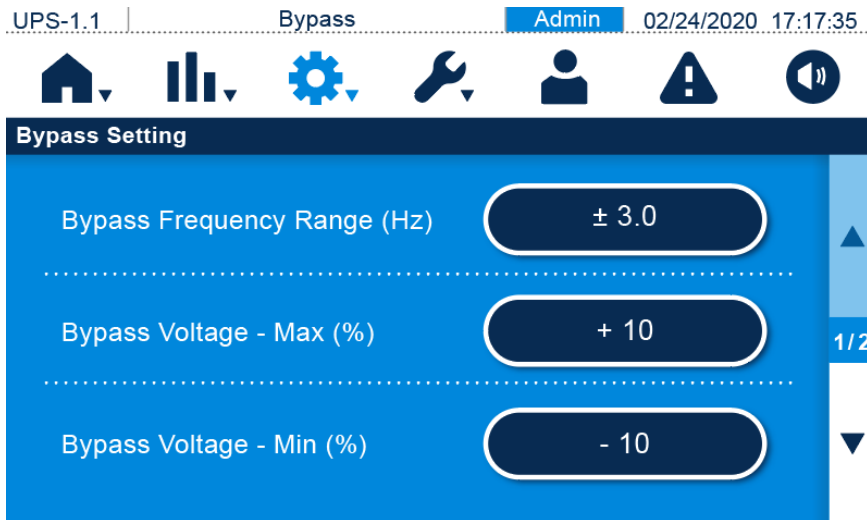

Item	Description
Bypass Frequency Range	Set up the bypass output's frequency range.
Bypass Voltage - Max	Set up the bypass output's maximum voltage.
Bypass Voltage - Min	Set up the bypass output's minimum voltage.
ECO Voltage - Max	Set up the bypass output's maximum voltage in ECO mode.
ECO Voltage - Min	Set up the bypass output's minimum voltage in ECO mode.

7.9.2 Mode Setting

In the **Mode Setting** screen, the administrator can set up the UPS system mode, of which there are four options: **On-line**, **ECO**, **Energy Recycle** and **Frequency Conversion**. These settings must be performed by qualified service personnel. Please contact Delta service personnel for assistance.

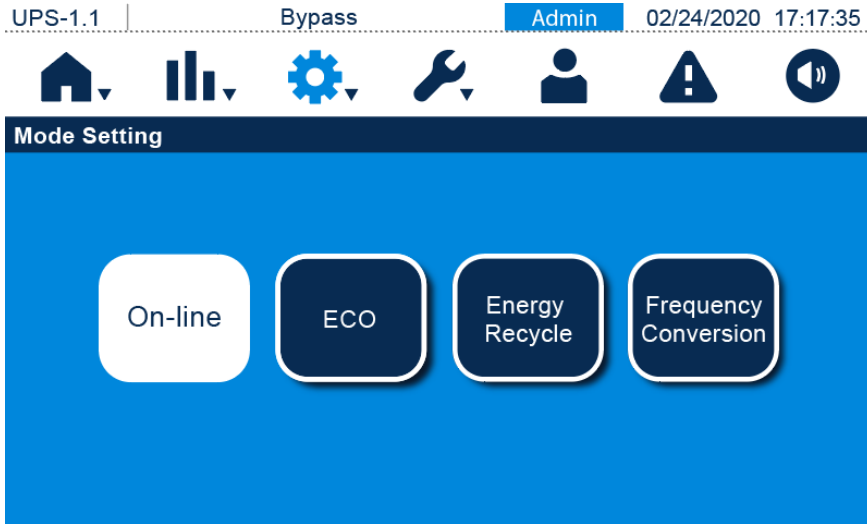



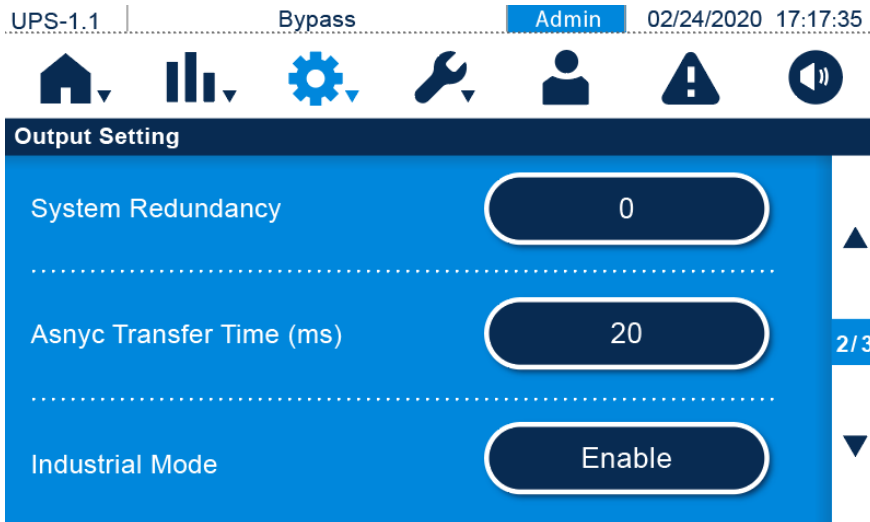
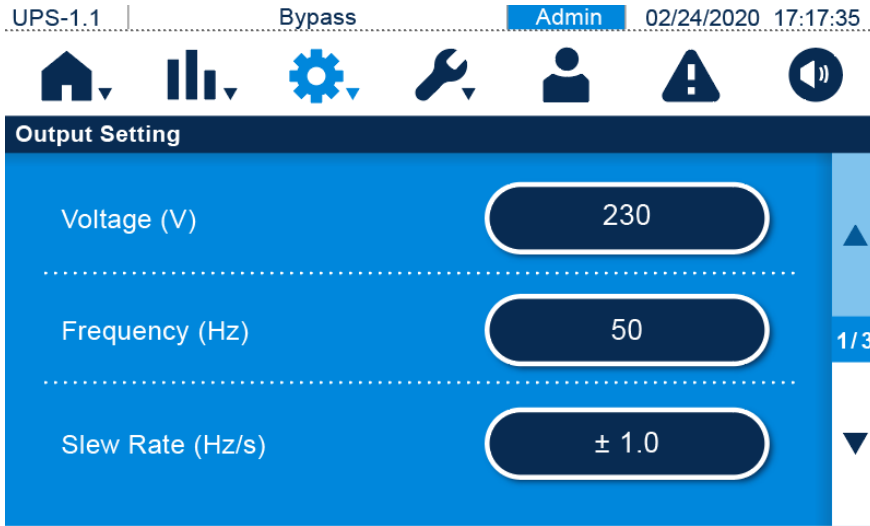

Item	Description
On-line	Set up the UPS in on-line mode. In on-line mode, it is the inverter to supply power to the connected loads.
ECO	Set up the UPS in ECO mode. In ECO mode, it is the bypass to supply power to the connected loads. It is suggested that you set the UPS in ECO mode only when there is stable main AC power. Otherwise, power supply quality will be compromised.
Energy Recycle	Set up the UPS in energy recycle mode. In energy recycle mode, the output with load can be simulated without real output to the loads.
Frequency Conversion	Set up the UPS in frequency conversion mode. In frequency conversion mode, it is the inverter to supply power to the connected loads with a fixed output frequency. Please note that the output will be terminated once the inverter is turned off.

7.9.3 Output Setting

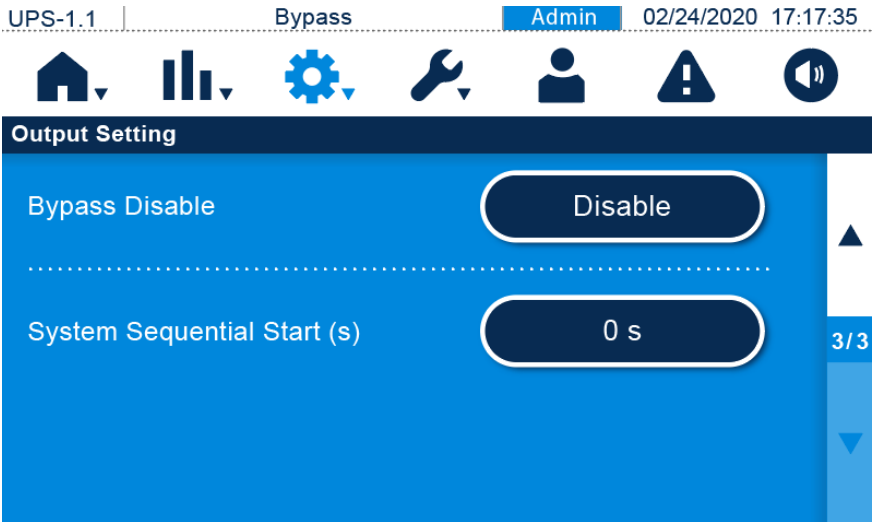
In the **Output Setting** screen, the administrator can set up **Voltage**, **Frequency**, **Slew Rate**, **System Redundancy**, **Asnyc Transfer Time**, **Industrial Mode**, **Bypass Disable** and **System Sequential Start**. These settings must be carried out by qualified service personnel, please contact Delta service personnel for assistance.





Item	Description
<p style="text-align: center;">Voltage</p>	<p>Set up the output voltage.</p> <p> NOTE: The output voltage can be modified only when the inverter is powered off, that is bypass mode or standby mode.</p>
<p style="text-align: center;">Frequency</p>	<p>Set up the output frequency as 50Hz (default) or 60Hz. The system will automatically select the output frequency in accordance with the bypass power.</p> <p> NOTE: The frequency can be modified only when the inverter is powered off, that is bypass mode or standby mode.</p>
<p style="text-align: center;">Slew Rate</p>	<p>Set up the maximum permissible speed for the UPS output frequency to catch up the bypass frequency variation.</p> <p> NOTE: The slew rate can be modified only when the inverter is powered off, that is bypass mode or standby mode.</p>

Item	Description
System Redundancy	Set up how many UPSs that need to be preserved for redundancy.  NOTE: The system redundancy can be modified only when the inverter is powered off, that is bypass mode or standby mode.
Asnyc Transfer Time	When it is impossible for the inverter to reach synchronous phase lock with the bypass, the output will be terminated during conversion process according to this setup time.
Industrial Mode	Set up the industrial mode (disable or enable (default)).
Bypass Disable	Set up the bypass disable (disable (default) or enable).
System Sequential Start	Set up the time interval for the UPS to be converted from the battery mode to online mode. The setup is applicable to the generator to avoid bearing the whole loads right away.

7.9.4 Battery and Charging Setting

In the **Battery and Charging Setting** screen, the administrator can set up the following items (as shown in the figure below). These settings must be carried out by qualified service personnel, please contact Delta service personnel for assistance.

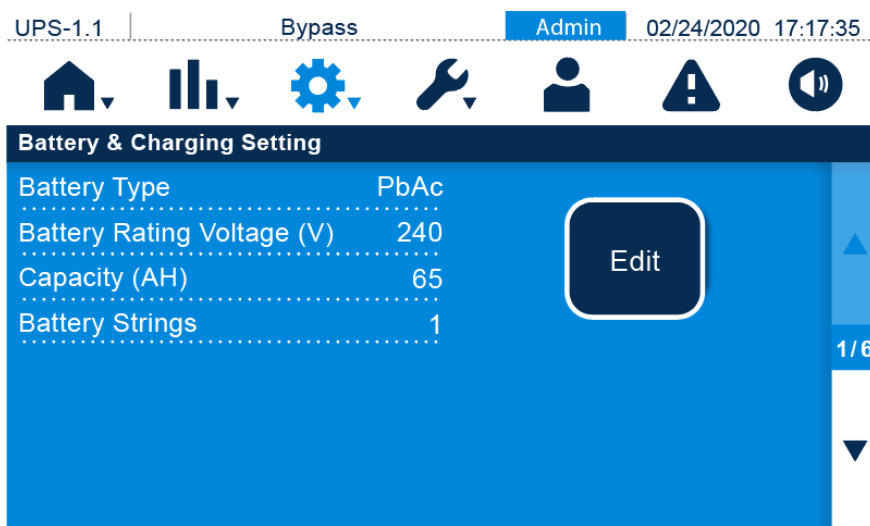

UPS-1.1 | Bypass Admin 02/24/2020 17:17:35

Home | Bar Chart | Settings | Wrench | User | Alert | Speaker

Battery & Charging Setting

Battery Low Warning (V)	220.0	Equalized Charge	
Battery Cut Off Voltage (V)	200.0	Voltage (V)	280.0
Battery Test Fail Voltage (V)	230.0	Charge Current -	
Float Charge Voltage (V)	272.0	Max (A)	3

2/6

Edit

UPS-1.1 | Bypass Admin 02/24/2020 17:17:35

Home | Bar Chart | Settings | Wrench | User | Alert | Speaker

Battery & Charging Setting

Auto Equalized Charge Disable

Auto Equalized Charge Period (Days) 1

Auto Equalized Charge Time (Mins) 1

3/6

UPS-1.1 | Bypass Admin 02/24/2020 17:17:35

Home Bar Chart Gear Wrench User Alarm Speaker

Battery & Charging Setting

Automatic Battery Test Period (Days) ▲

4/6

Battery Test Duration (Mins) ▼

UPS-1.1 | Bypass Admin 02/24/2020 17:17:35

Home Bar Chart Gear Wrench User Alarm Speaker

Battery & Charging Setting

Low Temperature Alarm (°C) ▲

5/6

High Temperature Alarm (°C) ▼

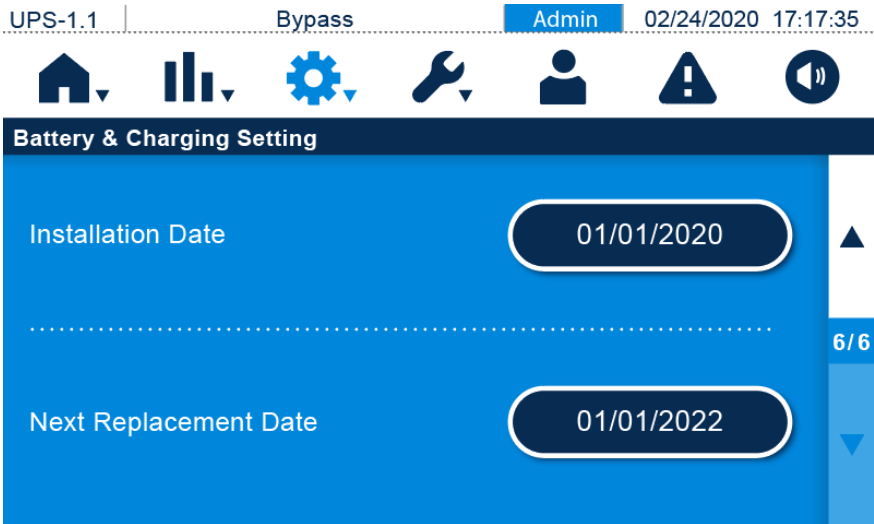

Item	Description
Battery Type*¹	Set up the battery type.
Battery Rating Voltage*¹	Set up the battery rating voltage.
Capacity*¹	Set up the battery capacity.
Battery Strings*¹	Set up how many battery strings that are used on site.
Battery Low Warning*¹	Set up the battery low warning voltage.
Battery Cut Off Voltage*¹	Set up the battery low voltage. In battery mode, when the battery low voltage is reached, the battery power will cut off, the UPS will shut down, and the connected loads won't be protected.
Battery Test Fail Voltage*¹	Set up the battery test fail voltage.
Float Charge Voltage*¹	Set up the float charge voltage.
Equalized Charge Voltage	Set up the equalized charge voltage.
Charge Current - Max*¹	Set up the maximum charge current.
Auto Equalized Charge	Enable or disable the auto equalized charge.
Auto Equalized Charge Period	Set up the auto equalized charge interval.
Auto Equalized Charge Time	Set up the auto equalized charge time.
Automatic Battery Test Period*¹	Set up the auto battery test interval.

Item	Description
Battery Test Duration*¹	Set up how long the battery test should last.
Low Temperature Alarm*¹	Enable or disable the low temperature alarm. If enabled, set up the temperature.
High Temperature Alarm*¹	Enable or disable the high temperature alarm. If enabled, set up the temperature.
Installation Date*¹	Record the battery installation date.
Next Replacement Date*¹	Set up the battery replacement date.



NOTE: If you need to use li-ion batteries,

1. Please set up the items marked with *¹ in the above table according to the li-ion batteries characteristics of different li-ion manufacturers. If the li-ion battery BMS (Battery Management System) needs to control the charging switch of li-ion batteries, please connect the output control signal to the input dry contacts of the UPS, and set up the status of the input dry contacts (Charger Off (Positive) and Charger Off (Negative)) through the UPS touch panel. For detail setting method, please refer to **4.6 Input Dry Contacts**.
2. These settings must be carried out by qualified service personnel, please contact Delta service personnel for assistance.

7.9.5 Parallel Setting

In the **Parallel Setting** screen, you can set up **Parallel Group ID**, **Parallel ID** and **Common Battery**. These settings must be carried out by qualified service personnel, please contact Delta service personnel for assistance.

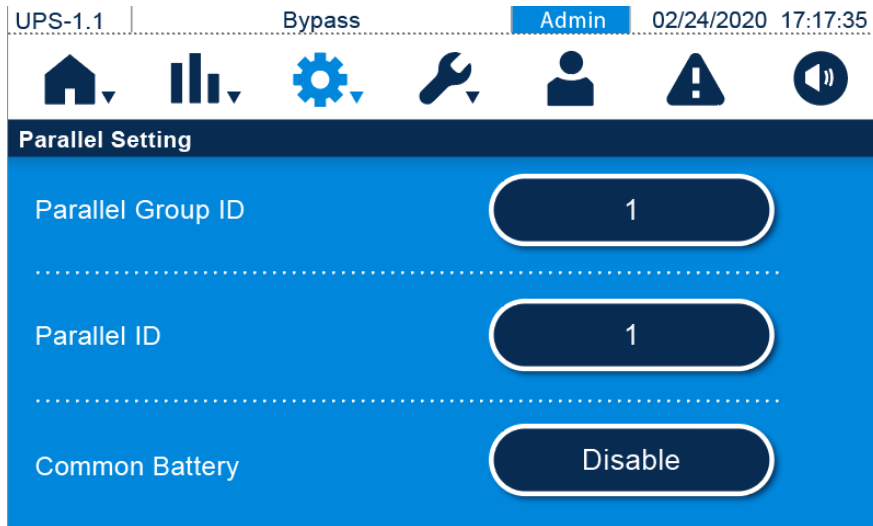

Item	Description
Parallel Group ID	The UPSs in parallel connection must be assigned the same parallel group ID. In order to let the outputs of the parallel UPSs be put in parallel connection and let the loads be evenly distributed among the parallel units. If the parallel UPSs have different parallel group ID No., their output signals might be synchronized but their outputs cannot be connected in parallel.
Parallel ID	The UPSs that need to be paralleled must be assigned the same parallel group ID No. and different parallel ID No. in order to let the parallel function work.
Common Battery	If the parallel UPSs that have the same parallel group ID No. need to share common batteries, please select 'Enable' for the 'Common Battery' setup item. Otherwise, the function of battery abnormality detection will fail.

7.9.6 Dry Contact Setting

In the **Dry Contact Setting** screen, you can set up the events of **input and output dry contacts**. These settings must be carried out by qualified service personnel, please contact Delta service personnel for assistance.

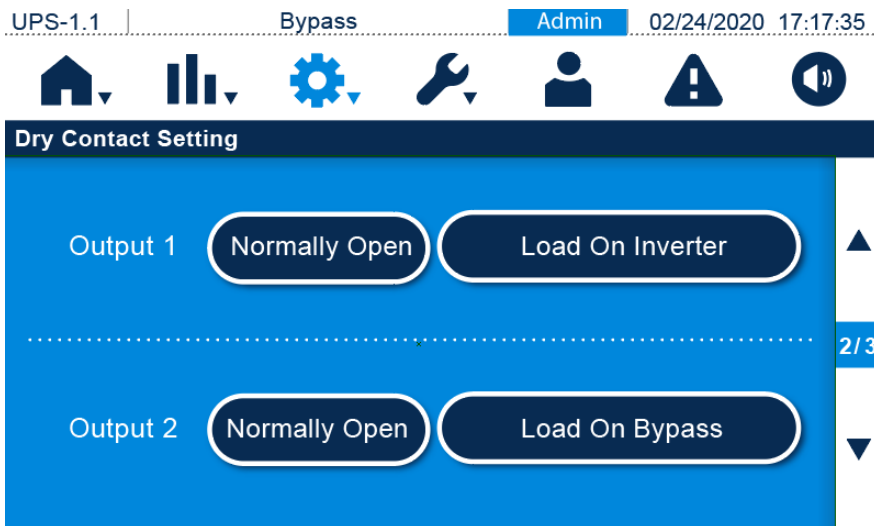
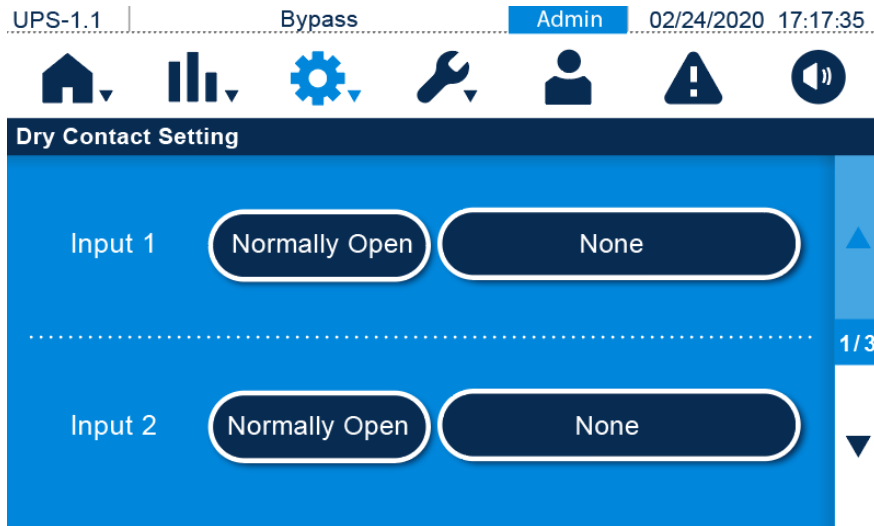

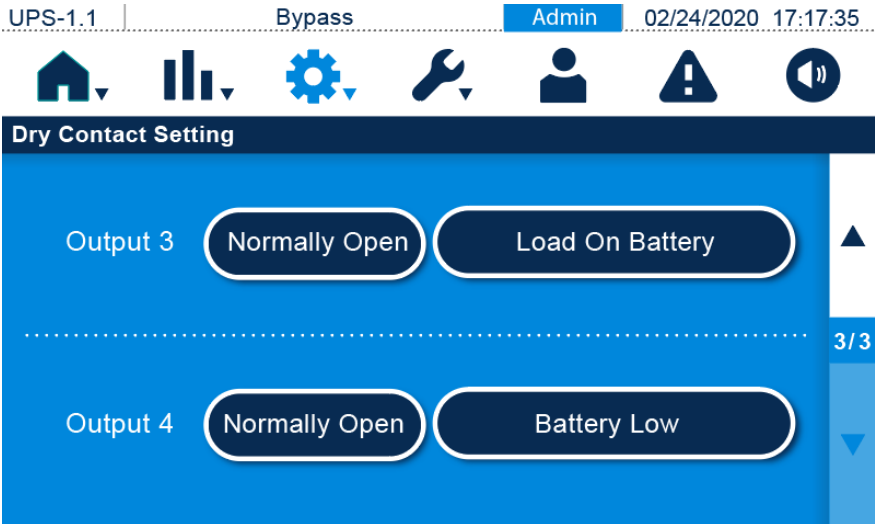

Item	Description	
Input 1 Input 2	Select one of the following events as the setting for each input dry contact. For detail setting, please refer to Table 4-1 Input Dry Contact Events and Description .	Set up NO (normally open) or NC (normally closed) for each input dry contact.
Output 1 Output 2 Output 3 Output 4	Select one of the following events as the setting for each output dry contact. For detail setting, please refer to Table 4-2 Input Dry Contact Events and Description .	Set up NO (normally open) or NC (normally closed) for each output dry contact.

7.9.7 General Setting

In the **General Setting** screen, the user can set up **Date Format**, **Date**, **Time**, **Screen Brightness**, **Screen Sleep (after)** and **Language**. Other settings must be carried out by qualified service personnel, please contact Delta service personnel for assistance.

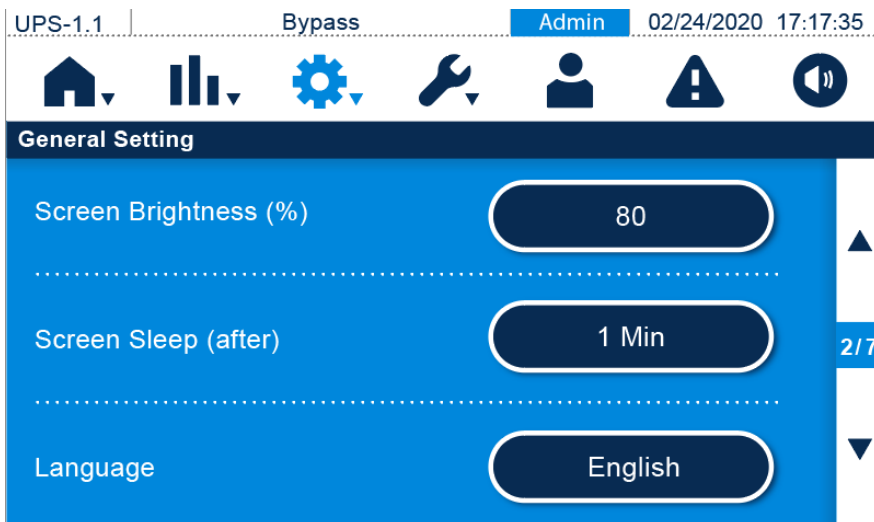
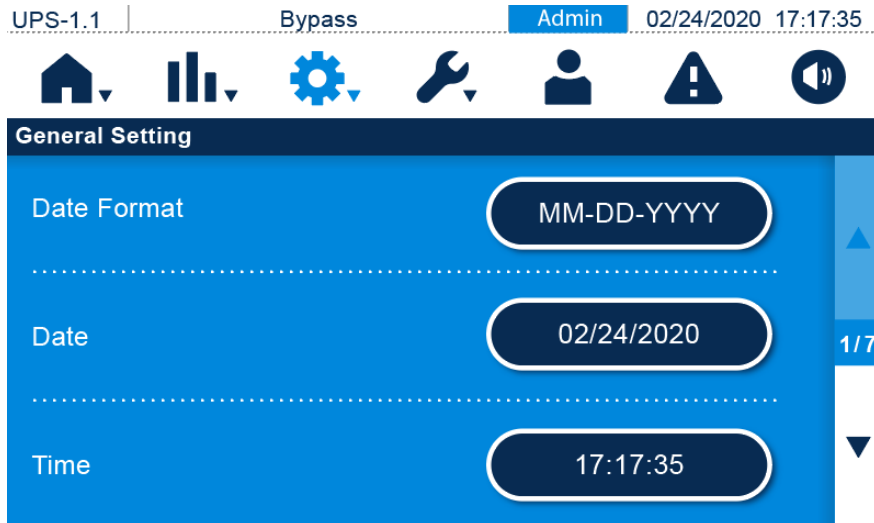

UPS-1.1 | Bypass Admin 02/24/2020 17:17:35

Home, Bar Chart, Gear, Wrench, User, Warning, Speaker

General Setting

Dust Filter Installation	Disable	▲
Dust Filter Installation Date	01/01/2000	3/7
Estimated Dust Filter Replacement Date	01/01/2000	▼

UPS-1.1 | Bypass Admin 02/24/2020 17:17:35

Home, Bar Chart, Gear, Wrench, User, Warning, Speaker

General Setting

Fan Replacement Warning	Disable	▲
Fan Installation Date	01/01/2000	4/7
Estimated Fan Replacement Date	01/01/2000	▼

UPS-1.1 | Bypass Admin 02/24/2020 17:17:35

Home | Bar Chart | Gear | Wrench | User | Alert | Speaker

General Setting

CAP Replacement Warning Disable ▲

CAP Installation Date 01/01/2000 5/7

Estimated CAP Replacement Date 01/01/2000 ▼

UPS-1.1 | Bypass Admin 02/24/2020 17:17:35

Home | Bar Chart | Gear | Wrench | User | Alert | Speaker



General Setting





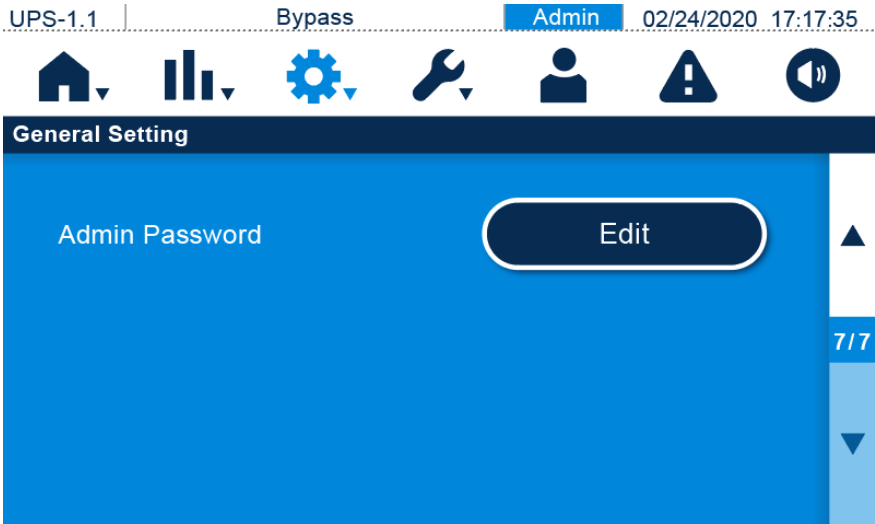

IGBT Replacement Warning Disable ▲

IGBT Installation Date 01/01/2000 6/7

Estimated IGBT Replacement Date 01/01/2000 ▼



Item	Sub Item	Description
Date/ Time	Date Format	Select the date format.
	Date	Set up the date.
	Time	Set up the time.
Screen	Screen Brightness	Adjust the touch panel display brightness (default: 80).
	Screen Sleep (after)	Set up the touch panel backlight sleep time (default: 1 minute).
User	Language	Set up the display language (default: English).
	Admin Password	Set up the administrator password (4 digits).
Dust Filter	Dust Filter Installation	If you have installed the dust filter, please select ' Enable '. The default setting is ' Disable '.
	Dust Filter Installation Date	Set up the dust filter installation date.  NOTE: Only when you select ' Enable ' for ' Dust Filter Installation ' can you set up the ' Dust Filter Installation Date '.
	Estimated Dust Filter Replacement Date	Set up the dust filter replacement date. When the date is due, the alarm message ' Replace Dust Filter ' will be displayed in touch panel.  NOTE: Only when you select ' Enable ' for ' Dust Filter Installation ' can you set up the ' Estimated Dust Filter Replacement Date '.

Item	Sub Item	Description
Fan	Fan Replacement Warning	If you need ' Fan Replacement Warning ', please select ' Enable '. The default setting is ' Disable '.
	Fan Installation Date	Set up the fan installation date.  NOTE: Only when you select ' Enable ' for ' Fan Replacement Warning ' can you set up the ' Fan Installation Date '.
	Estimated Fan Replacement Date	Set up the fan replacement date. When the date is due, the alarm message ' Replace Fan ' will be displayed in touch panel.  NOTE: Only when you select ' Enable ' for ' Fan Replacement Warning ' can you set up the ' Estimated Fan Replacement Date '.
CAP	CAP Replacement Warning	If you need ' CAP Replacement Warning ', please select ' Enable '. The default setting is ' Disable '.
	CAP Installation Date	Set up the CAP installation date.  NOTE: Only when you select ' Enable ' for ' CAP Replacement Warning ' can you set up the ' CAP Installation Date '.
	Estimated CAP Replacement Date	Set up the CAP replacement date. When the date is due, the alarm message ' Replace CAP ' will be displayed in touch panel.  NOTE: Only when you select ' Enable ' for ' CAP Replacement Warning ' can you set up the ' Estimated CAP Replacement Date '.
IGBT	IGBT Replacement Warning	If you need ' IGBT Replacement Warning ', please select ' Enable '. The default setting is ' Disable '.
	IGBT Installation Date	Set up the IGBT installation date.  NOTE: Only when you select ' Enable ' for ' IGBT Replacement Warning ' can you set up the ' IGBT Installation Date '.
	Estimated IGBT Replacement Date	Set up the IGBT replacement date. When the date is due, the alarm message ' Replace IGBT ' will be displayed in touch panel.  NOTE: Only when you select ' Enable ' for ' IGBT Replacement Warning ' can you set up the ' Estimated IGBT Replacement Date '.

7.9.8 Control

In the **Control** screen, the user can set up **Buzzer**. The setting of **Force Equalized Charge**, **Force Bypass to Inverter**, **Force Inverter to Bypass** and **Reset System** must be carried out by qualified service personnel, please contact Delta service personnel for assistance.

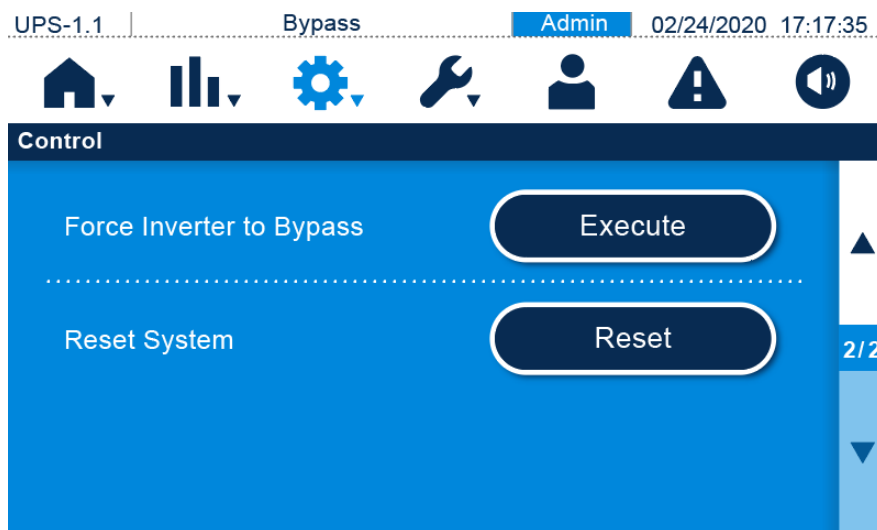
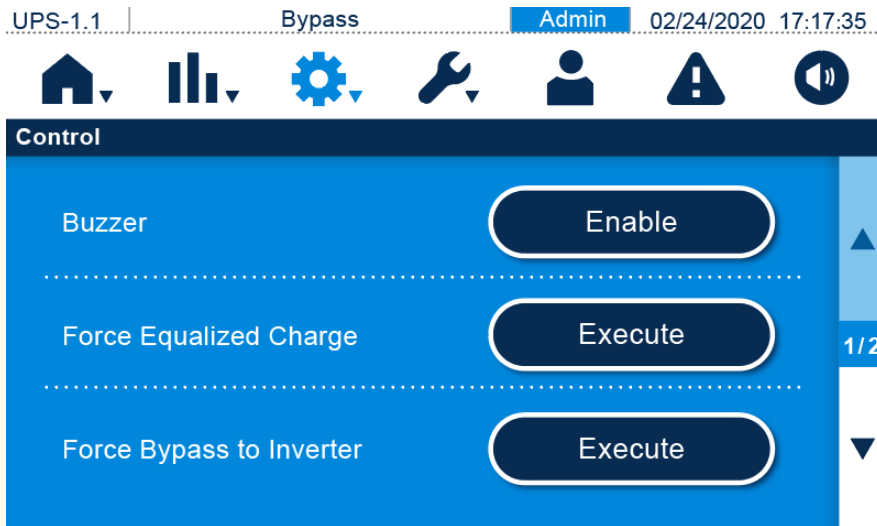

Item	Description
Buzzer	Enable or disable the buzzer. Default setting is enable.
Force Equalized	Manually force the UPS to run in auto equalized charge mode to

Item	Description
Charge	charge the batteries.
Force Bypass to Inverter	Manually force the UPS to switch from bypass to inverter when the inverter keeps staying in the soft-start status and is unable to transfer to on-line mode successfully.
Force Inverter to Bypass	Manually force the UPS to switch from inverter to bypass when any emergency occurs.
Reset System	Reset the system or not. In bypass mode, when you press the ON/ OFF button (⏻) to start up the UPS but the UPS does not respond, please select ' Reset ' to reset the system. After the system is reset, please press the ON/ OFF button (⏻) to start up the UPS.

7.10 Maintenance

There are seven shortcut buttons for you to check and set up the **Warning, Historical Event, Statistics, Test, Clear, Advanced Diagnosis** and **Version & S/N** respectively. Please see the figure below.

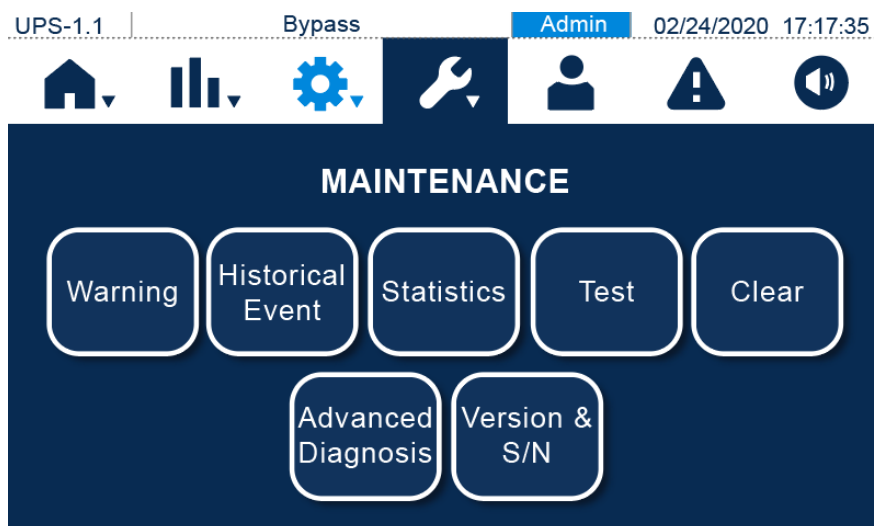

7.10.1 Warning

When there is a warning, the buzzer will make an alarm sound. Click the warning icon () to enter the **Warning** screen.







In the **Warning** screen, you can inquire the warning logs and solutions. The system can store at maximum 200 warning logs.



NOTE:

Click the number on the right side of the warning screen (as shown in the figure below) and enter a specific page number, you can quickly switch to the corresponding page and view the warning logs.

UPS-1.1 | Bypass | Admin | 02/24/2020 17:17:35



      

No	Log	Solution
34	Mains Input Volt Out Range	Please contact service personnel for more information
33	Mains Input Volt Out Range - T	Please contact service personnel for more information
32	Mains Input Volt Out Range - RS	Please contact service personnel for more information
31	Mains Input Volt Out Range - ST	Please contact service personnel for more information

The number '1' in the right margin of the table is highlighted with a red box.

7.10.2 Historical Event

The **Historical Event** screen shown below provides each **Historical Event's No.**, **Start Time**, **Code** (red: serious; orange: minor; green: normal) and **Log Description**.

You can click the icon () to check the entire historical event description, also can click the download icon () to download the historical event logs. The UPS can save up to 10000 historical event logs.



NOTE:

1. The download icon () will appear at the upper right corner of the screen only after inserting the USB flash drive into the USB port.

- Click the number on the right side of the historical event screen (as shown in the figure below) and enter a specific page number, you can quickly switch to the corresponding page and view the historical event logs.

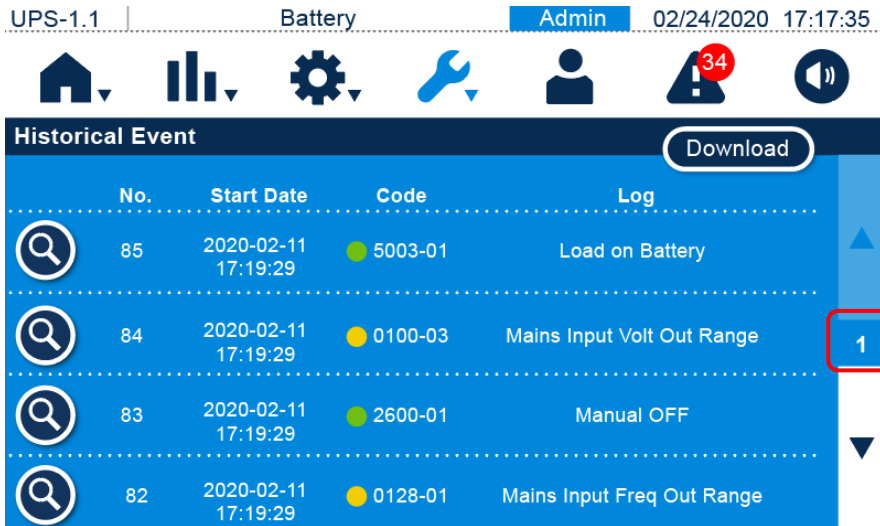

7.10.3 Statistics

In the **Statistics** screen, the user can inquire **On Battery Mode, Battery Mode Duration, On Bypass Mode, Bypass Mode Duration** and **Operation Time**.

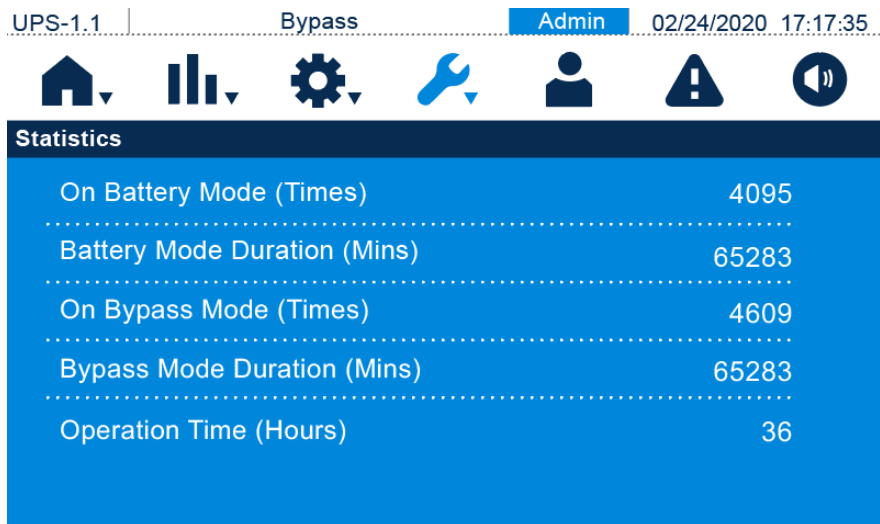

Item	Description
On Battery Mode	Means how many times that the UPS runs in battery mode.
Battery Mode Duration	Means how long the UPS runs in battery mode.

Item	Description
On Bypass Mode	Means how many times that the UPS runs in bypass mode.
Bypass Mode Duration	Means how long the UPS runs in bypass mode.
Operation Time	Means how long the UPS has operated.

7.10.4 Test

In the **Test** screen, the user can perform **Buzzer & LED Test**, and the administrator can perform **Manual Battery Test** and **Battery Depth of Discharge Test**.

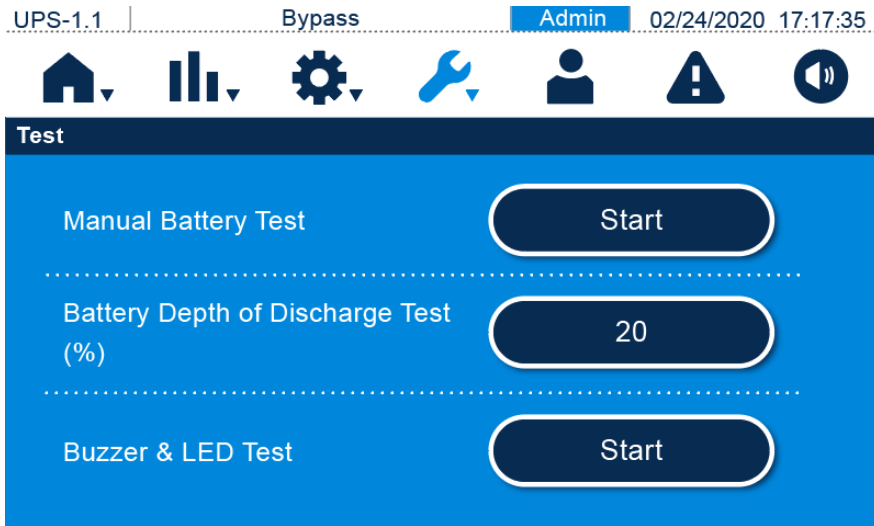

7.10.5 Clear

In the **Clear** screen, you can clear the records of **Statistics**, **kWH**, **Historical Event** and **Battery Test Result**.

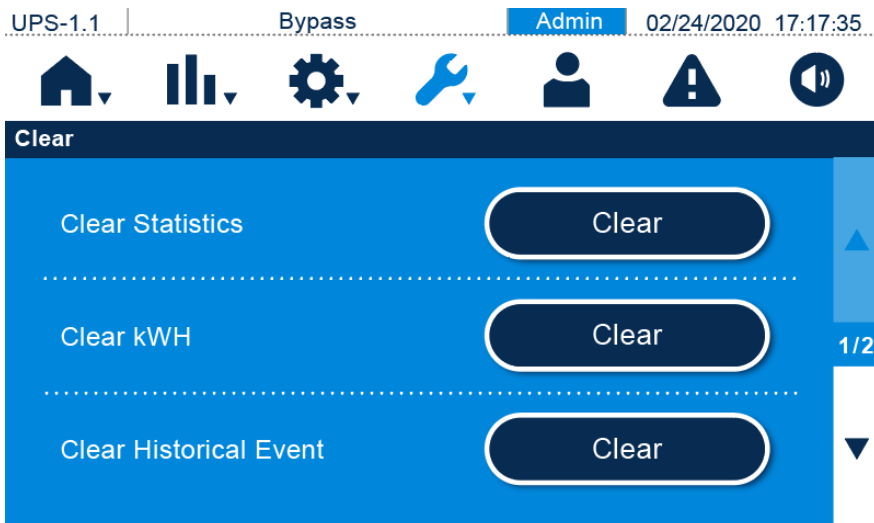

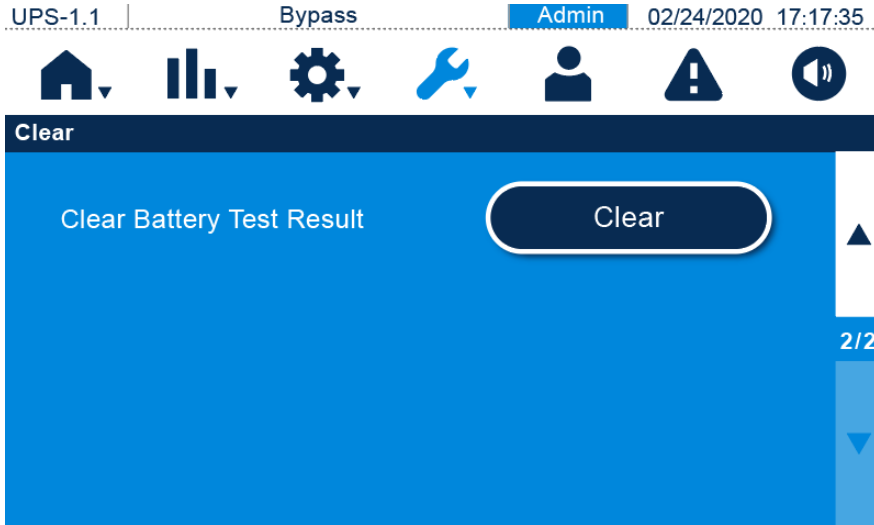

NOTE:

The records mentioned above are important information for UPS analysis and maintenance. Do not clear any of them without the consent of qualified service personnel.

7.10.6 Advanced Diagnosis

In the **Advanced Diagnosis** screen, the administrator can check **System Temperature** and **INV Temperature**.

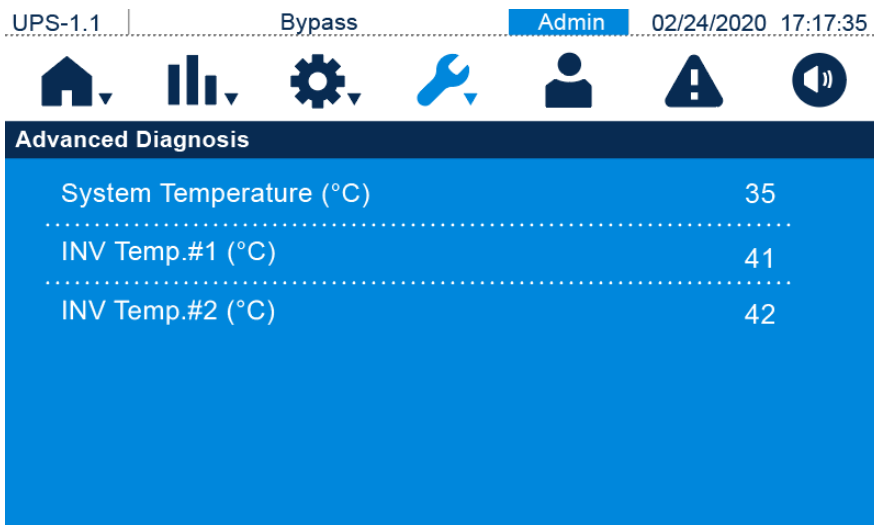

7.10.7 Version & S/N

In the **Version & S/N** screen, you can check **Model Name**, **S/N**, **Touch Panel FW Version** and **System FW Version**, and can upgrade **Touch Panel FW version** and **System FW version**. **Touch Panel FW version** and **System FW version** upgrading must be carried out by qualified service personnel, please contact Delta service personnel for assistance.

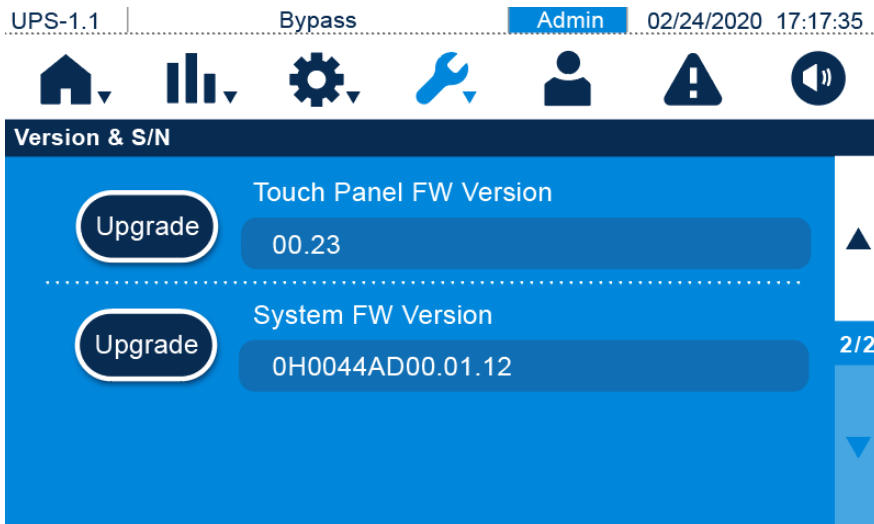
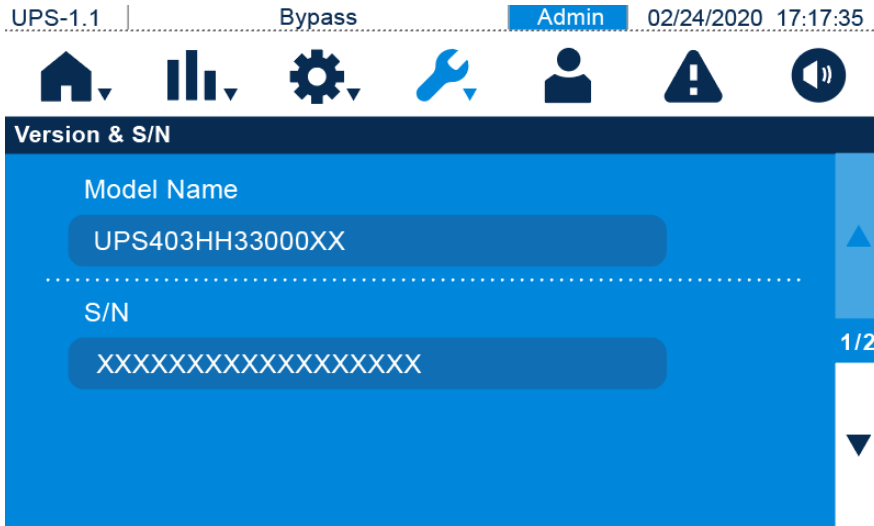

Chapter 8: Optional Accessories

There are several optional accessories available for the HPH series UPS. Please refer to the table below for the optional accessories and their functions. If you need any of the optional accessories, please contact your local dealer.

No.	Item	Functions
1	Dust Filter	Prevents dust from entering into the UPS to ensure UPS reliability and to prolong product lifespan.
2	Mini SNMP Card (IPv6)	Monitors and controls the status of the UPS via a network system.
3	Mini Relay I/O Card	Increases the quantity of dry contacts.
4	Mini MODBUS Card	Lets the UPS have MODBUS communication function.
5	EnviroProbe 1000	Monitors temperature, humidity and other connected monitoring devices in a room environment. The EnviroProbe 1000 should work with Mini SNMP card or EnviroStation.
6	EPO Kit	For UPS emergent power off.
7	IP42 Kit	Prevents dust and water drops from entering into the UPS to ensure UPS reliability and to prolong product lifespan.
8	Parallel Cable (5-meter long)	Connects the parallel UPSs.
9	Parallel Cable (10-meter long)	Connects the parallel UPSs.
10	External Battery Cabinet Temperature Detection Cable	Detects the temperature of external battery and compensate the charging voltage according to the detected value. Used as charging voltage compensation.

Chapter 9: Maintenance

UPS

- **UPS Cleaning**

Regularly clean the UPS, especially the slits, openings and filters, to ensure that the air freely flows into the UPS to avoid overheating. If necessary, use a vacuum cleaner to clean the slits and openings, and clean and replace the filters regularly to prevent any object from blocking or covering these areas.

- **UPS Regular Inspection**

- a. Regularly check, clean or replace the filters according to the UPS using environment, to avoid UPS overheating.
- b. Regularly check the UPS every half year and inspect:
 - 1) Whether the UPS, tri-color LED indicators, and any warning message.
 - 2) Whether the UPS works in bypass mode (normally, the UPS works in normal mode). If yes, check if any error, overload, internal fault, etc. occurs.
 - 3) Whether battery voltage is normal. If the battery voltage is too high or too low, find the root cause.

Batteries

The HPH Series UPS uses sealed lead-acid batteries. The battery life depends on the environment temperature, the usage, and the charging/ discharging frequency. High temperature environments and high charging/ discharging frequency will quickly shorten the battery life. Please follow the suggestions below to ensure a normal battery lifetime.

- Keep the usage temperature at 15°C ~25°C.
- When the UPS needs to be stored for an extended period of time, the batteries must be recharged once every three months and the charging time must not be less than 24 hours each time.



NOTE:

1. If the batteries need to be replaced, please contact qualified service personnel. During battery replacement, the loads connected to the UPS will not be protected if input power fails.

Fans

Higher temperatures will shorten fan life. When the UPS is running, please check if all of the fans work normally and make sure if the ventilation air can move freely around and through the UPS. If not, replace the fans immediately.



NOTE:

Please ask your local dealer or customer service for more maintenance information. Do not perform maintenance if you are not trained for it.

Appendix 1: Technical Specifications

Model		HPH-20K	HPH-30K	HPH-40K
Power Rating		20kVA/20kW	30kVA/30kW	40kVA/40kW
Waveform		Sine Wave		
Input	Nominal Voltage	220/380 Vac; 230/400 Vac; 240/415 Vac		
	Voltage Range	176 ~ 276/ 305 ~ 478 Vac (100% Load) 132 ~ 276/ 228 ~ 478Vac (70% ~ 100% Load)		
	Frequency	50/60 Hz		
	Frequency Range	40 ~ 70 Hz		
	Input Current	46A	61A	78A
	Power Factor	> 0.99 (full load)		
Output	Voltage	220/380 Vac; 230/400 Vac; 240/415 Vac		
	Power Factor	1		
	Voltage Regulation	±1%		
	Voltage Harmonic Distortion	< 1.5% (linear load)		
	Overload Capability	≤ 105%: continuous; 105% ~ ≤ 110%: 60 minutes; 110% ~ ≤ 125%: 10 minutes; 126% ~ ≤ 150%: 1 minute; > 150%: 1 second		
	Output Frequency	50/60 Hz ± 0.05 Hz		
	Crest Factor	3:1		
Efficiency	Online Mode	Up to 96%		
	ECO Mode	Up to 99%		
Battery & Charger	Type	SMF/ VRLA		
	Battery Voltage	± 240 Vdc		
	Maximum Charge Current	15A		
	Charge Voltage	Float charge 272 ± 2 Vdc Equalized charge 280 ± 2 Vdc		
Audible Noise		< 50 dBA	< 56 dBA	

Model		HPH-20K	HPH-30K	HPH-40K
Display		Tri-color LED indicators and 5" touch panel		
Communication Interfaces		Mini Slot × 2, Parallel Port × 2, RS232 Port × 1, USB Port × 1, EXT BATT TEMP Port × 1, REPO Port × 1, Input Dry Contact × 2, Output Dry Contact × 4		
Manual Bypass Switch		Yes		
Physical	Dimensions (W × D × H)	240 × 630 × 650 mm		
	Weight	44kg	50kg	
Environment	Operating Altitude	1000 meters (without de-rating)		
	Operating Temperature	0 ~ 40°C		
	Relative Humidity	0% ~ 95% (non-condensing)		



NOTE:

1. Please refer to the rating label for the safety rating.
2. All specifications are subject to change without prior notice.

Appendix 2: Warranty

Seller warrants this product, if used in accordance with all applicable instructions, to be free from original defects in material and workmanship within the warranty period. If the product has any failure problem within the warranty period, Seller will repair or replace the product at its sole discretion according to the failure situation.

This warranty does not apply to normal wear or to damage resulting from improper installation, operation, usage, maintenance or irresistible force (i.e. war, fire, natural disaster, etc.), and this warranty also expressly excludes all incidental and consequential damages.

Maintenance service for a fee is provided for any damage out of the warranty period. If any maintenance is required, please directly contact the supplier or Seller.



WARNING:

The individual user should take care to determine prior to use whether the environment and the load characteristic are suitable, adequate or safe for the installation and the usage of this product. The User Manual must be carefully followed. Seller makes no representation or warranty as to the suitability or fitness of this product for any specific application.

No.: 501328520304

Version: V 3.4

Release Date: 2023_03_09

- Global Headquarter

Taiwan

Delta Electronics Inc.
39 Section 2, Huandong Road, Shanhua District,
Tainan City 74144, Taiwan
T +886 6 505 6565
E ups.taiwan@deltaww.com

- Regional Office

The United States

Delta Electronics (Americas) Ltd.
46101 Fremont Blvd. Fremont, CA 94538
T +1 510 344 2157
E ups.na@deltaww.com

Australia

Delta Energy Systems Australia Pty Ltd.
Unit 20-21, 45 Normanby Road, Notting Hill VIC 3168, Australia
T +61 3 9543 3720
E ups.australia@deltaww.com

South America

Delta Electronics Brasil Ltda.
Estrada Velha Rio-São Paulo, 5300 – Eugênio de Melo – CEP 12247-001
São José dos Campos-SP-Brasil
T +55 12 39322300
E ups.brazil@deltaww.com

Thailand

Delta Electronics (Thailand) Public Co.,Ltd.
909 Soi 9, Moo 4, E.P.Z., Bangpoo Industrial Estate, Tambon Prakasa,
Amphur Muang-samutprakarn, Samutprakarn Province 10280, Thailand
T +662 709-2800
E ups.thailand@deltaww.com

China

Delta GreenTech (China) Co., Ltd.
238 Minxia Road, Pudong, Shanghai, 201209 P.R.C
T +86 21 5863 5678
+86 21 5863 9595
E ups.china@deltaww.com

South Korea

Delta Electronics (Korea), Inc.
1511, Byucksan Digital Valley 6-cha, Gasan-dong, Geumcheon-gu,
Seoul, Korea, 153-704
T +82-2-515-5303
E ups.south.korea@deltaww.com

Singapore

Delta Electronics Int'l (Singapore) Pte Ltd.
4 Kaki Bukit Ave 1, #05-04, Singapore 417939
T +65 6747 5155
E ups.singapore@deltaww.com

India

Delta Electronics India Pvt. Ltd.
Plot No. 43, Sector-35, HSIDC, Gurgaon-122001, Haryana, India
T +91 124 4874 900
E ups.india@deltaww.com

EMEA

Delta Electronics (Netherlands) BV
Zandsteen 15, 2132MZ Hoofddorp, The Netherlands
T +31 20 655 09 00
E ups.netherlands@deltaww.com

Japan

Delta Electronics (Japan), Inc.
2-1-14 Shibadaimon, Minato-Ku, Tokyo, 105-0012, Japan
T +81-3-5733-1111
E jpstps@deltaww.com

UK

Delta Electronics (UK) Ltd.
Eltek House Cleveland Road, Hemel Hempstead Industrial Estate,
Hemel Hempstead, Hertfordshire, HP2 7EY
T +44 1442 219355
E sales.gb@eltek.com

