



The power behind competitiveness

# Delta UPS Amplon Family

RT Gen3 Series, Single Phase  
1/ 2/ 3 kVA

User Manual

## SAVE THIS MANUAL

This manual contains important instructions and warnings that you should follow during the installation, operation, storage and maintenance of this product. Failure to heed these instructions and warnings will void the warranty.

Copyright © 2026 by Delta Electronics Inc. All Rights Reserved. All rights of this User Manual ("Manual"), including but not limited to the contents, information, and figures are solely owned and reserved by Delta Electronics Inc. ("Delta"). The Manual can only be applied to the operation or the use of this product. Any disposition, duplication, dissemination, reproduction, modification, translation, extraction, or usage of this Manual in whole or in part is prohibited without the prior written permission of Delta. Given that Delta will continuously improve and develop the product, changes may be made to the information in this Manual at any time without obligation to notify any person of such revision or changes. Delta will make all possible efforts to secure the accuracy and the integrity of this Manual. Delta disclaims any kinds or forms of warranty, guarantee, or undertaking, either expressly or implicitly, including but not limited to the completeness, faultlessness, accuracy, non-infringement, merchantability or fitness for a particular purpose of the Manual.

# Table of Contents

<b>Chapter 1 : Important Safety Instructions</b>	<b>1</b>
1.1 Installation Warnings	1
1.2 Connection Warnings	1
1.3 Usage Warnings	2
1.4 Storage	3
1.5 Standard Compliance	4
<b>Chapter 2 : Introduction</b>	<b>5</b>
2.1 General Overview	5
2.2 Package Inspection	5
2.3 Operating Principle	7
2.4 Exterior & Dimensions	7
2.5 Front View	9
2.6 Rear View	10
<b>Chapter 3 : Installation</b>	<b>17</b>
3.1 Rack Mounting	17
3.2 Tower Mounting	19
4.1 UPS Connection & Setup	21
<b>Chapter 4 : Connection</b>	<b>21</b>
4.2 Battery Replacement (for Standard Runtime Model only)	23
<b>Chapter 5 : Operation</b>	<b>25</b>
5.1 Multi-function Buttons	25
5.2 LCD Panel	26
5.3 Audible Alarm	28

5.4	LCD Display Wordings Index -----	29
5.5	UPS Setting -----	30
5.6	Operation Modes -----	35
5.7	Fault Reference Code-----	36
5.8	Warning Indicator-----	37
<b>Chapter 6 : Optional Accessories -----</b>		<b>38</b>
<b>Chapter 7 : Troubleshooting -----</b>		<b>39</b>
<b>Chapter 8 : Maintenance -----</b>		<b>42</b>
<b>Appendix 1 : Technical Specifications -----</b>		<b>44</b>
<b>Appendix 2 : Warranty -----</b>		<b>50</b>

# Chapter 1 : Important Safety Instructions

## 1.1 Installation Warnings

- Before installation and usage, please read this *User Manual* thoroughly. This helps you to use the product correctly and safely.
- Do not install, use, operate and maintain the UPS if you are not trained for it.
- Install the UPS in a well-ventilated indoor area, away from excess moisture, heat, dust, flammable gas or explosives. To avoid fire accidents and electric shock, the indoor area must be free of conductive contaminants. For the temperature and humidity specifications, please refer to *Appendix 1: Technical Specifications*.
- Leave adequate space around all sides of the UPS for proper ventilation and maintenance.
- Follow the IEC 60364-4-42 standard to install the UPS.

## 1.2 Connection Warnings

- Do not connect appliances or devices which would overload the UPS (e.g. laser printers) to the UPS's output sockets.
- Do not connect domestic appliances such as hair dryers to the UPS's output sockets.
- It is not recommended to connect the UPS with the following types of loads. For the load suitability, please contact Delta customer service before purchasing.
  1. regenerative loads (e.g. CNC machines and lifts)
  2. asymmetrical loads (e.g. fans with half-bridge drivers and laser printers)
- Place cables in such a way that no one can step on or trip over them.
- Connect the UPS only to an earthed shockproof outlet which must be easily accessible and close to the UPS.
- Please only use the VDE-tested and CE-marked mains cable (e.g. the mains cable of your computer) to connect the UPS to the building wiring outlet (shockproof outlet).

- Please only use the VDE-tested and CE-marked power cables to connect the loads to the UPS.
- When installing the equipment, please ensure that the sum of the leakage current of the UPS and the connected devices does not exceed 3.5 mA.

### 1.3 Usage Warnings

- Only qualified service personnel can upgrade the UPS's firmware.
- Before applying electrical power to the UPS, you must allow the UPS to adjust to room temperature 20 ~ 25°C (68 ~ 77°F) for at least one hour and ensure that there is no moisture condensing inside the unit.
- Do not dismantle the UPS.
- Do not disconnect the mains to the UPS or the building wiring outlet (shockproof socket outlet) during operation since this would disable the protective earthing of the UPS and of all connected loads.
- The UPS features its own and some models have internal current source (batteries). The UPS's output sockets or output terminal blocks may be electrically live even if the UPS is not connected to the building wiring outlet.
- Please replace fuse(s) only with the same type and amperage in order to avoid fire hazards.
- In order to completely disconnect the UPS from the mains, please first press the **OFF/ ENTER** button.
- Do not pour and splash any liquid on the UPS. Do not insert any object into the UPS's slits and openings. Do not put beverages on or around the UPS.
- The UPS operates with hazardous voltage. Repairs must be only carried out by qualified service personnel.



#### **WARNING:**

- Risk of electric shock! Even after the unit is disconnected from the mains (building wiring outlet), components inside the UPS are still connected to the batteries and electrically live and dangerous.
- Before carrying out any kind of service and/ or maintenance, disconnect the batteries from the UPS and verify that no current is present and no hazardous voltage exists in the terminals of high capability capacitor such as BUS capacitors.

- Only qualified personnel can perform battery replacement. Unauthorized personnel shall be kept away from the batteries.



**WARNING:**

Risk of electric shock! The battery circuit is not isolated from the input voltage. Hazardous voltage may occur between the battery terminals and the ground.

- Do not dispose of the battery or batteries in a fire. The batteries may explode.
- Do not open or damage the battery or batteries. The released electrolyte is harmful to the skin and eyes and may be toxic.
- Only use the same type of batteries from the same supplier. Never use old, new and different Ah batteries at the same time.
- A battery can present a risk of electrical shock and high short-circuit current. Contact with any part of a grounded battery can result in electrical shock. The following precautions should be observed when working on batteries:
  1. Remove watches, rings, or other metal objects.
  2. Use tools with insulated handles.
  3. Wear rubber gloves and boots.
  4. Do not lay tools or metal parts on top of the batteries.
  5. Disconnect charging source and loads prior to installing or maintaining the batteries.
  6. Remove battery grounds during installation and maintenance to reduce likelihood of shock. Remove the connection from ground if any part of the battery is determined to be grounded. Please note that the battery grounds mean any battery pole (+/ -) connecting to the ground.

## 1.4 Storage

- Use the original packing materials to pack the UPS to prevent any possible damage.
- **Prior to installation:**

If the UPS needs to be stored prior to installation, it should be placed in a dry and well-ventilated indoor area. The allowable storage temperature is between -20°C (-4°F) and 50°C (122°F) and the allowable relative humidity (non-condensing) is between 10% and 90%.

- **After usage:**

Press and hold the **OFF/ ENTER** button for at least 2 seconds to turn off the UPS. Make sure the UPS is completely shut down, disconnect the UPS from the utility AC power, remove all loads from the UPS and store the UPS in a dry and well-ventilated indoor area at a temperature of between -20°C (-4°F) and 50°C (122°F) and at a relative humidity (non-condensing) between 10% and 90%. If the UPS needs to be stored for an extended period of time, please recharge the idle batteries regularly. Please refer to the table below.

Storage Temperature	Recharge Frequency	Charging Duration
-20 ~ 40°C (-4 ~ 104°F)	Every 3 months	Whenever you recharge the batteries (internal or/ and external), please fully charge them until the Battery Level indicator  is fully on.
40 ~ 50°C (104 ~ 122°F)	Every 2 months	

## 1.5 Standard Compliance

- CE
- UKCA
- IEC 62040-1
- IEC 62040-2

# Chapter 2 : Introduction

## 2.1 General Overview

The RT Gen 3 series UPS, available in 1kVA, 2 kVA and 3 kVA, is an online double-conversion UPS providing reliable and consistent sine-wave quality power to your equipment. It supports personal computers, networks, servers, telecommunication equipment and a variety of other facilities.

There are two models for selection to meet different backup time requirements, which are standard and extended runtime. For the extended runtime model, it can connect to the optional Delta external battery pack.

The unit provides output power factor up to 0.9, which produces greater electric power efficiency at low cost. It can handle wide input voltage range and keep your applications safe and running smoothly at all times.

## 2.2 Package Inspection

During UPS transportation, some unpredictable situations might occur. It is recommended that you inspect the UPS exterior packaging. If you notice any damage, please immediately contact the dealer from whom you purchased the unit.

Please check if any item is missing according to the following package list. If the UPS needs to be returned, carefully repack the UPS and all of the accessories using the original packing materials that came with the unit.

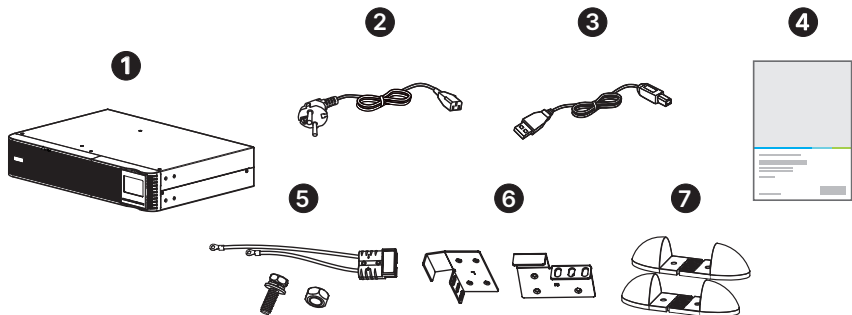

No.	Item	Q'ty
①	UPS* <sup>1</sup>	1 PC
②	Input Cable	1 PC
③	USB Cable	1 PC
④	User Manual	1 PC
⑤	Battery Cable Kit (for extended runtime model only)	1 Set (including battery cable × 1 PC, M5 screw × 2 PCS and M5 nut × 2 PCS)
⑥	Ear Bracket Kit	1 Set (including M4 screw × 8 PCS and ear bracket × 2 PCS)
⑦	Tower Stand	1 Set



**NOTE:**

\*<sup>1</sup> For more model information, please refer to ***Appendix I: Technical Specifications.***

## 2.3 Operating Principle

The operating principle of the UPS is shown as follows.

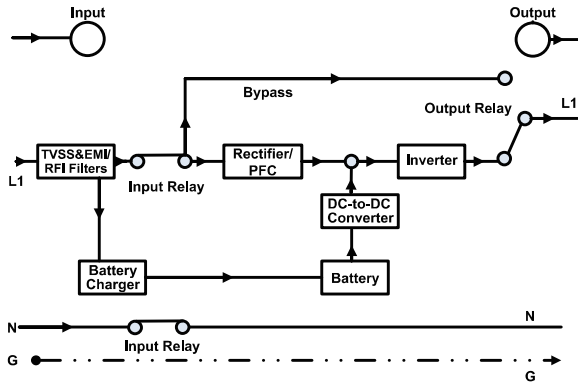

Figure 2-1: System Block Diagram

## 2.4 Exterior & Dimensions

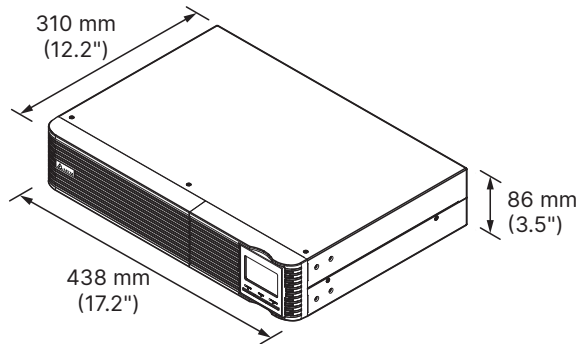

Figure 2-2: Exterior & Dimensions\_ 1kVA

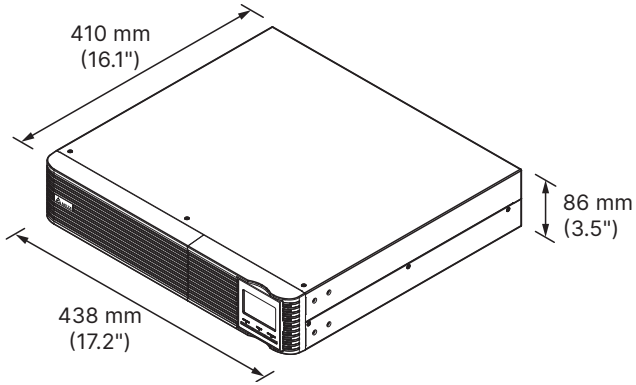
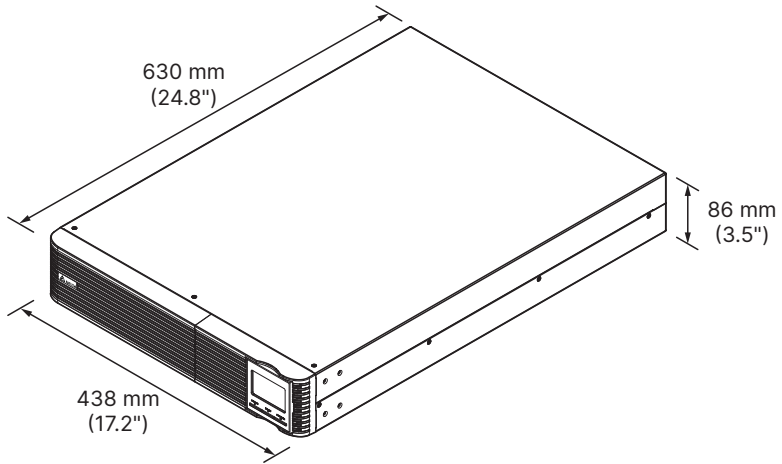
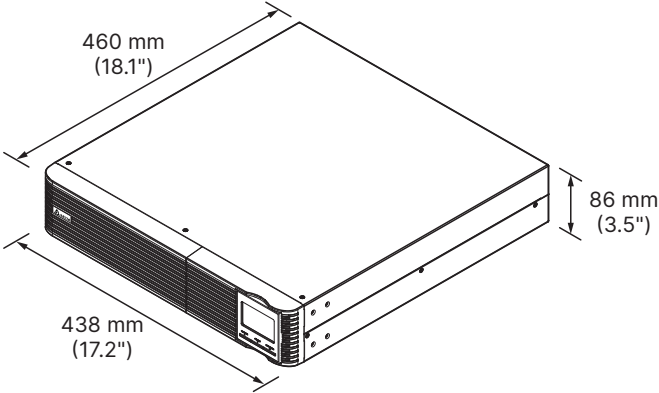

Figure 2-3: Exterior & Dimensions\_2kVA

### Standard Runtime Model



**Extended Runtime Model**



**Figure 2-4: Exterior & Dimensions\_ 3kVA**

**2.5 Front View**



**Figure 2-5: Front View**

## 2.6 Rear View

- Standard Runtime Model

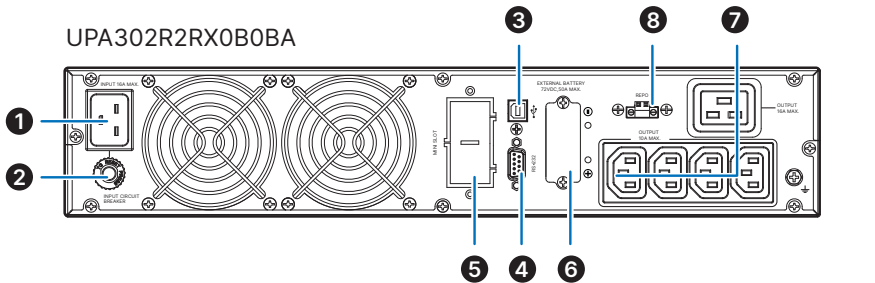
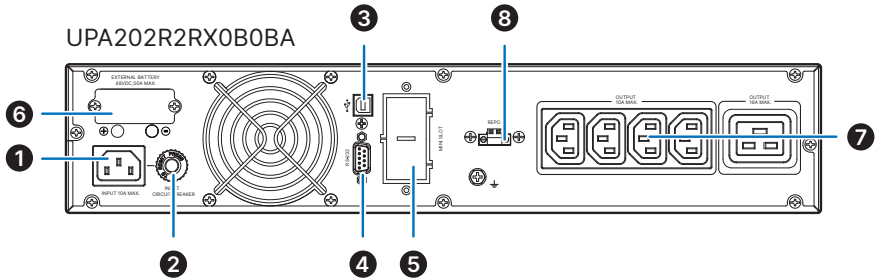
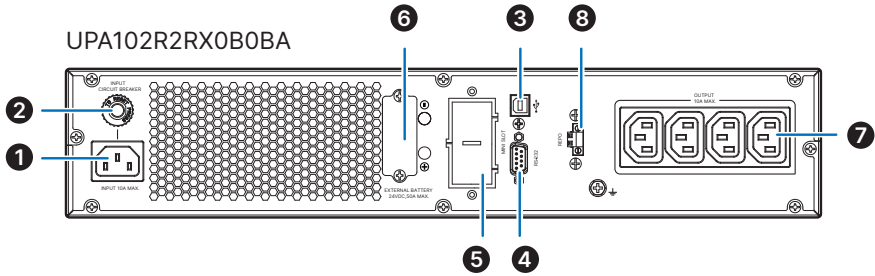

UPA102R2RX0B035

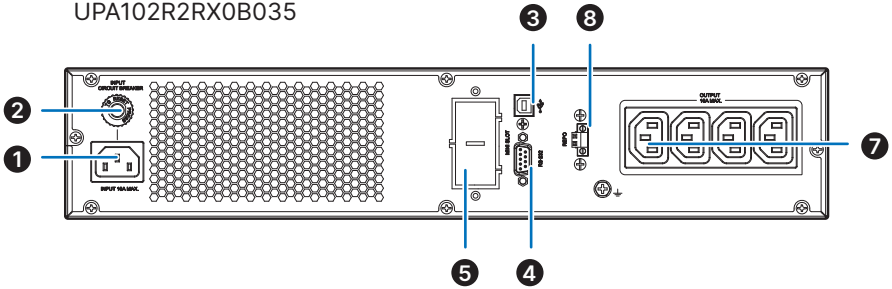

UPA202R2RX0B035

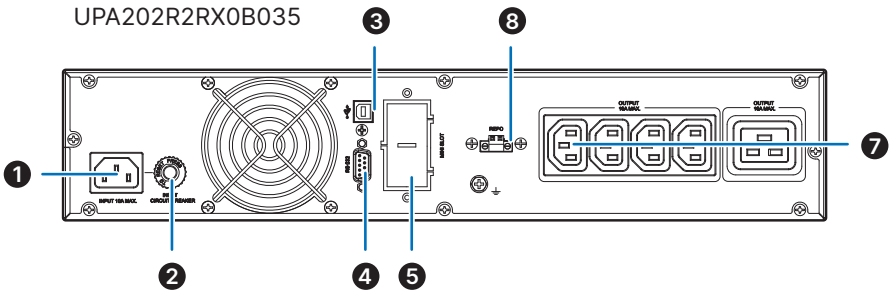

UPA302R2RX0B035

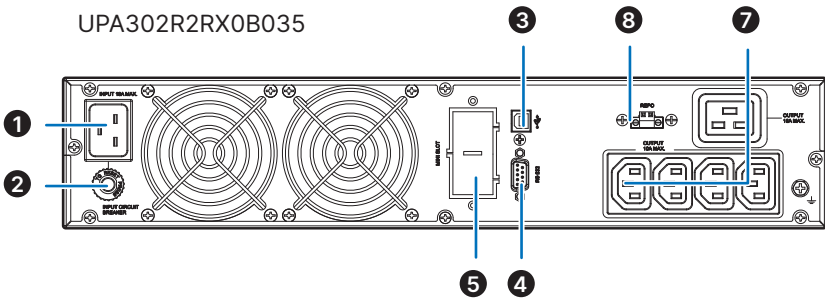

UPSRX102CB6B0-V

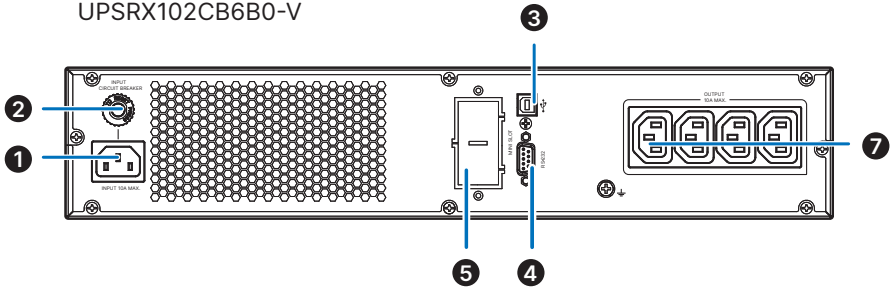

UPSRX202CB6B0-V

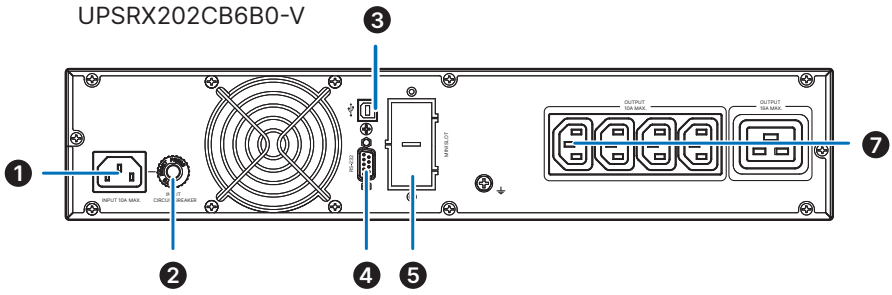

UPSRX302CB6B0-V

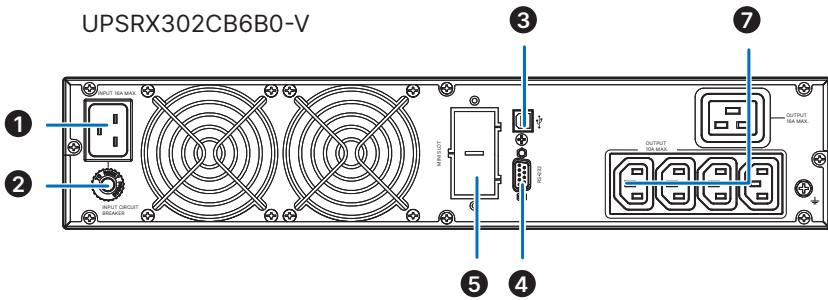

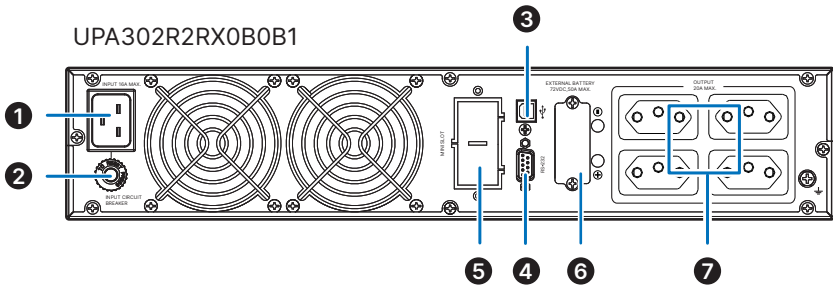
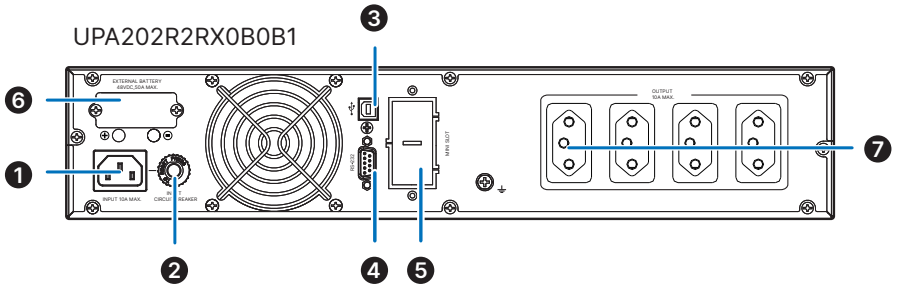
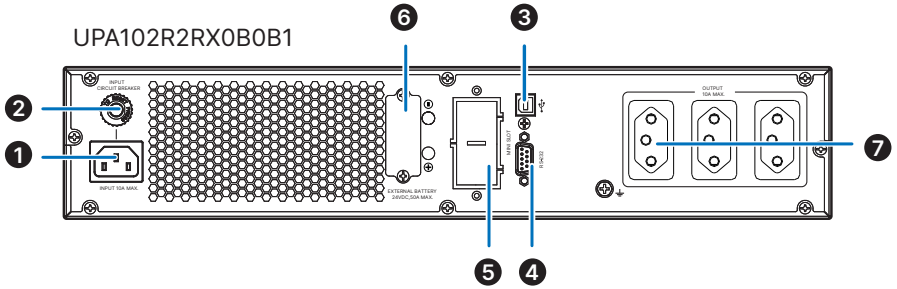

- Extended Runtime Model

UPA102R2RX2N035

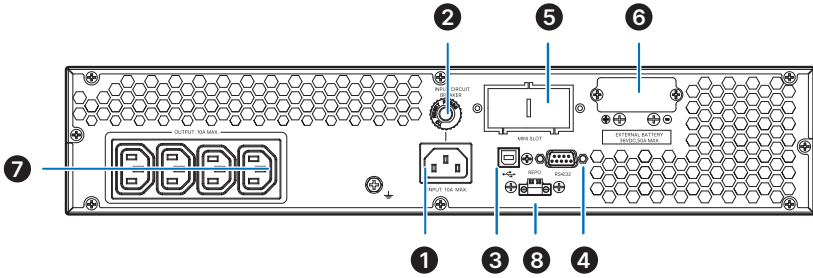

UPA202R2RX2N035

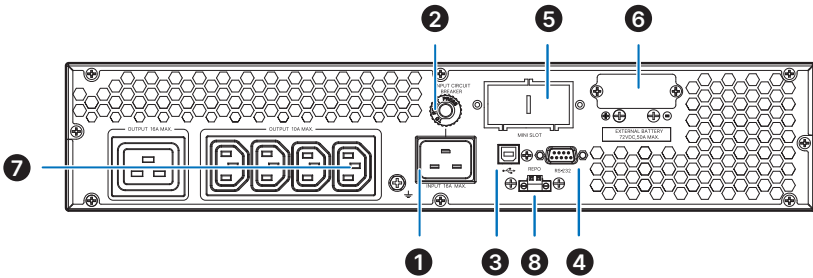

UPA302R2RX2N035

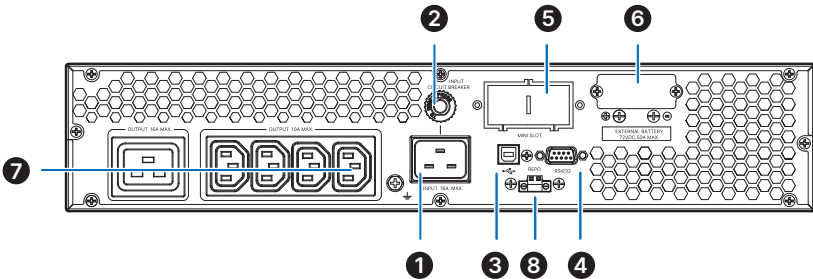

UPA102R2RX2N0B0  
UPSRX102CB6N0-V

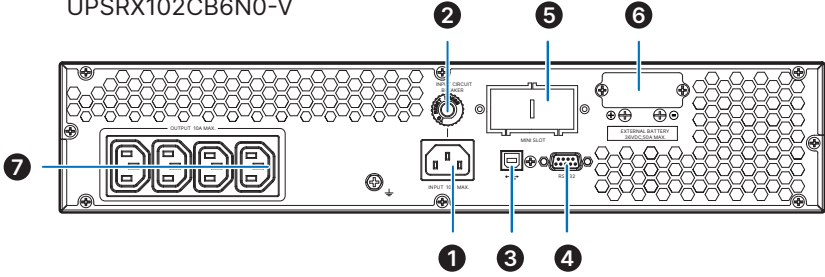

UPA202R2RX2N0B0  
UPSRX202CB6N0-V

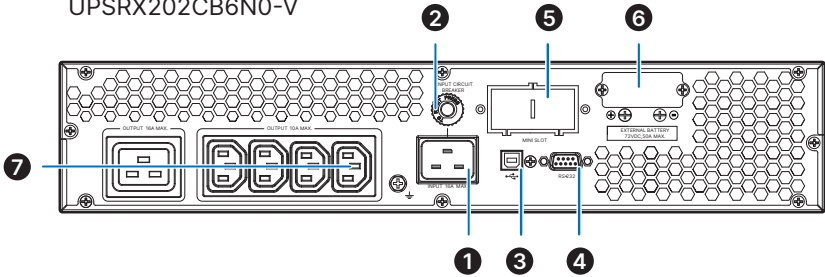

UPA302R2RX2N0B0  
UPSRX302CB6N0-V

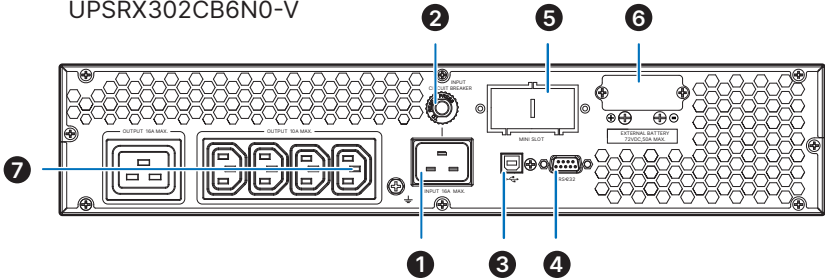

No.	Item
①	AC Input Socket
②	Input Circuit Breaker
③	USB Port
④	RS-232 Port
⑤	Mini Slot
⑥	External Battery Pack Connector
⑦	Output Receptacles
⑧	REPO Port

# Chapter 3 : Installation



## NOTE:

1. Before installation, please read *Chapter 1. Important Safety Instructions* thoroughly.
2. Only qualified personnel can perform installation. If you want to install the UPS by yourself, installation must be under the supervision of qualified personnel.
3. Before installation of the standard runtime model, please follow ① stated in *4.1 UPS Connection & Setup* to connect the battery cable first.
4. It is strongly recommended that at least two people lift the unit during rack-mounting process. If there is only one person available, we suggest that the UPS's internal batteries should be taken out (less weight) before rack-mounting. After rack-mounting, re-install the internal batteries.

## 3.1 Rack Mounting

The UPS can be rack-mounted in a 19" rack. Please use the rail kit (optional) and ear bracket kit (provided) to perform rack mounting.

- ① Attach the ear bracket kit to the lateral mounting holes of the UPS.

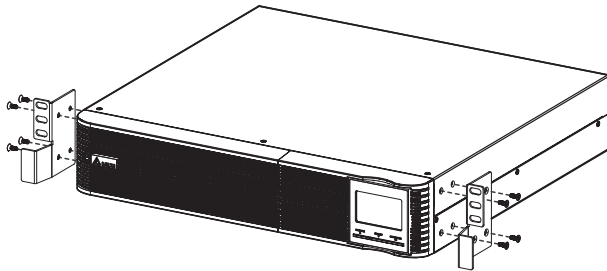

Figure 3-1: Install the Ear bracket Kit

- 2 Adjust the rails' length according to your rack and tighten the nuts.

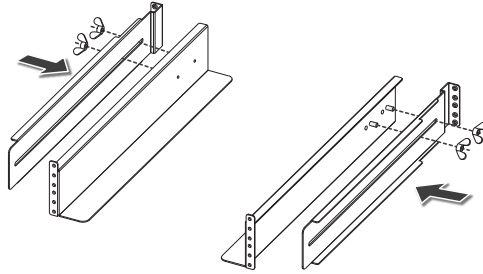

Figure 3-2: Adjust the Rails' Length and Tighten the Nuts

- 3 Use the eight screws and eight washers to attach the rails to your rack.

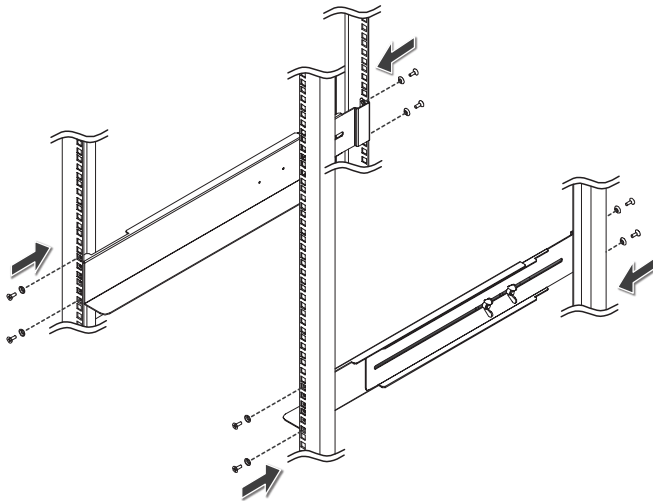

Figure 3-3: Attach the Rails to Your Rack

- 4 Insert the UPS into the rack and tighten the four screws.

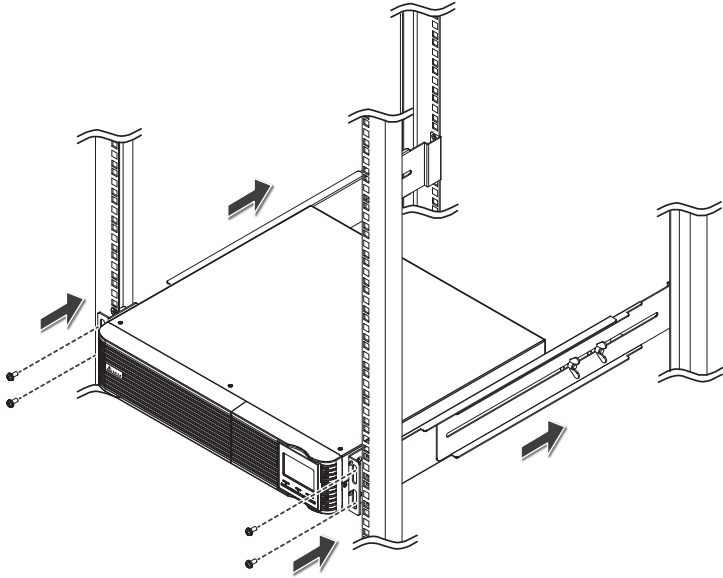

Figure 3-4: Insert the UPS into Your Rack

## 3.2 Tower Mounting

- 1 Assemble the provided tower stands.

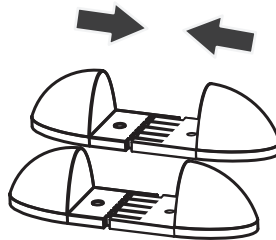
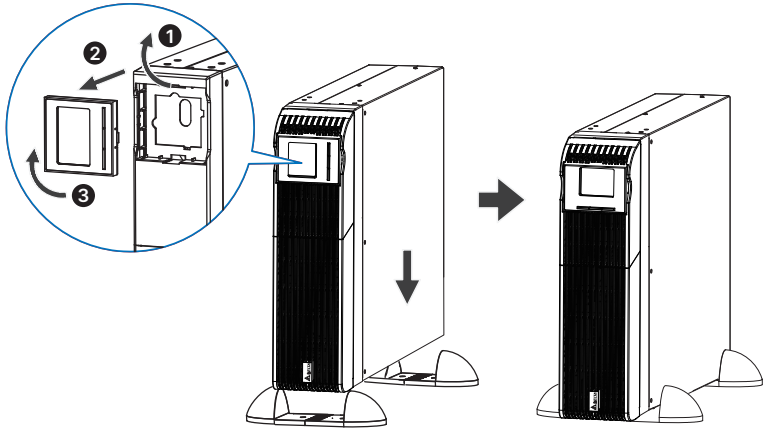

Figure 3-5: Assemble the Tower Stands

- 2 Place the UPS upright and install it inside the tower stands (at least two people are required). After that, follow 1 ~ 3 shown in the figure below to rotate the operation panel.



**Figure 3-6: Place the UPS Inside the Tower Stands & Rotate the Operation Panel**

# Chapter 4 : Connection

## 4.1 UPS Connection & Setup

### 1 Battery Cable Connection (for Standard Runtime Model only)

The UPS (standard runtime model only) is shipped out from the factory without connecting the battery cable for safety consideration. Before installing the UPS, please follow the steps below to connect the battery cable first.

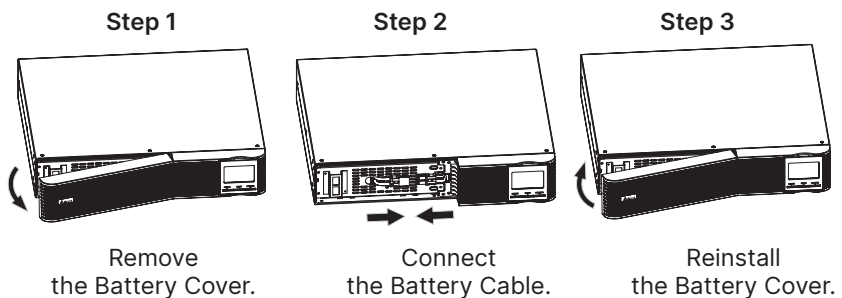

Figure 4-1: Battery Cable Connection

### 2 UPS Input Connection

Plug the UPS into a two-pole, three-wire and grounded receptacle only. Avoid using extension cords and only use the input cable provided in the package.

### 3 UPS Output Connection

Connect devices to the UPS's outlet receptacles.

### 4 Communication Interface Connection



Figure 4-2: Connection of USB Port, RS-232 Port and Mini Slot

To allow shutdown, start-up and status monitoring for unattended UPS, connect one end of the communication cable to the USB port or RS-232 port and the other to the communication port of your PC. With the monitoring software installed (<http://datacenter-softwarecenter.deltaww.com>), you can schedule shutdown and start-up of the UPS and monitor the UPS status via your PC.

The UPS is equipped with a Mini slot, where you can install the Mini SNMP card (optional). After installation of the Mini SNMP card, advanced communication and monitoring functions will be available.



**NOTE:**

1. Do not use the RS-232 port and the USB port at the same time.
2. If you choose to use the USB port instead of the RS-232 port, please install the USB driver software in your computer after connecting your computer to the UPS's USB port. The software can be downloaded from <http://datacenter-softwarecenter.deltaww.com>.

**5 Disabling/ enabling of REPO function**



**NOTE:**

Only applicable to models with P/N ending with 0BA and 035.

Keep pin 1 and pin 2 closed for UPS normal operation. To activate REPO function, cut the wire between pin 1 and pin 2.

The REPO port can be connected to an external switch. After the external switch is turned to the "OPEN" position, the UPS will switch off the inverter immediately and cut off the UPS output without transferring to the bypass mode.



**NOTE:**

The REPO port can also be used for ROO application, which allows you remotely turn on/ off the inverter. If you need detailed ROO information or ROO setup service, please contact your local dealer or customer service.

## 6 Turn-on of the UPS

Press the **ON/ Mute** button on the front operation panel for two seconds to power on the UPS.



### NOTE:

The UPS will be available for full runtime capability after the initial five-hour charging.

## 7 Installation of Software

For optimal system protection, install the UPS monitoring software to fully configure the UPS. Please download the software from <http://datacenter-softwarecenter.deltaww.com>

## 4.2 Battery Replacement (for Standard Runtime Model only)



### NOTE:

1. The UPS (standard runtime model only) is equipped with internal batteries and users can replace the batteries without shutting down the UPS or connected loads (hot-swappable battery design). Battery replacement is a safe procedure, isolated from electrical hazards.
2. Upon battery disconnection, equipment is not protected from power outages.



### WARNING:

Consider all warnings, cautions, and notes before replacing batteries.

1 Remove the battery cover.

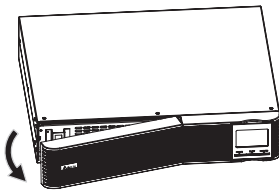

2 Disconnect the battery cable.

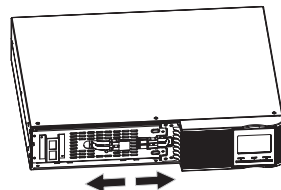

- 3) Unscrew the two screws and pull out the battery pack.

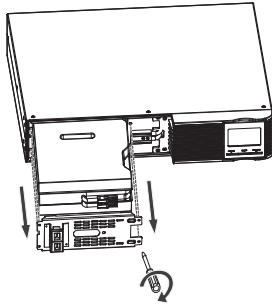

- 4) Replace the battery pack with a new one.

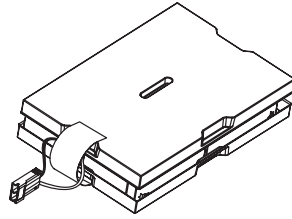

- 5) Install the new battery pack and secure the two screws.

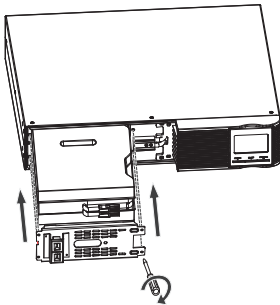

- 6) Reconnect the battery cable.

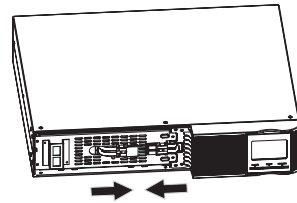

- 7) Re-install the battery cover.

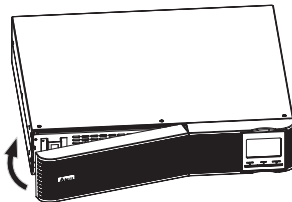

# Chapter 5 : Operation

## 5.1 Multi-function Buttons

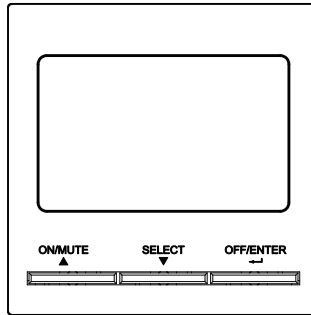







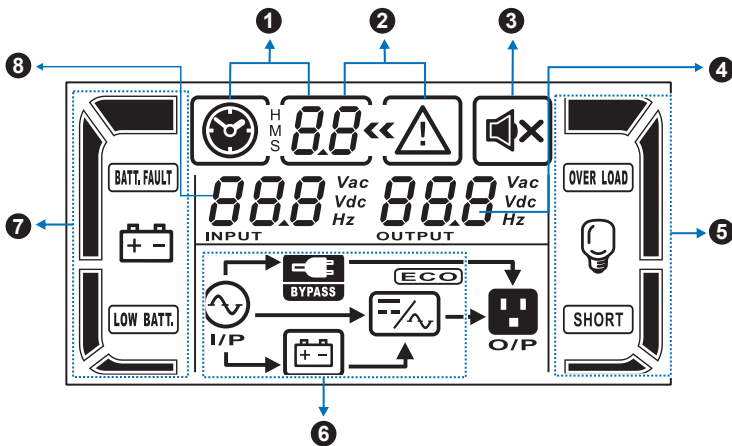











Multi-function Button	Function
<p><b>ON/ MUTE Button</b></p>	<ul style="list-style-type: none"> <li>• Turn on the UPS: Press and hold the <b>ON/ MUTE</b> button for at least 2 seconds to turn on the UPS.</li> <li>• Mute the alarm: When the UPS is in battery mode, press and hold this button for at least 5 seconds to disable or enable the alarm system. The <b>ON/ MUTE</b> button is not applicable when warnings or errors occur.</li> <li>• Up key: Press this button to display the previous selection in setting mode.</li> <li>• Switch to UPS self-test mode: Press and hold this button for 5 seconds to start UPS self-testing while in AC mode, ECO mode or converter mode.</li> </ul>
<p><b>OFF/ ENTER Button</b></p>	<ul style="list-style-type: none"> <li>• Turn off the UPS: Press and hold this button for at least 2 seconds to turn off the UPS. The UPS will switch to either standby mode or bypass mode according to your setting of bypass function. If you enable the bypass function, the UPS will transfer to bypass mode; if you disable the bypass function, the UPS will transfer to standby mode without any output. Please refer to <i>5.5 UPS Setting- 06: Enable/ disable bypass when the UPS is off.</i></li> <li>• Confirm selection key: Press this button to confirm selection in setting mode.</li> </ul>

Multi-function Button	Function
<p><b>SELECT Button</b></p>	<ul style="list-style-type: none"> <li>• Switch LCD message: Press this button to change the LCD message for input voltage, input frequency, battery voltage, output voltage and output frequency. It will return to default display when pausing for 10 seconds.</li> <li>• Setting mode: Press and hold this button for 5 seconds to enter setting mode when the UPS is in standby mode or bypass mode.</li> <li>• Down key: Press this button to display the next selection in setting mode.</li> </ul>
<p><b>ON/ MUTE + SELECT Buttons</b></p>	<ul style="list-style-type: none"> <li>• Switch to bypass mode: When the main power is normal, press the <b>ON/ MUTE</b> and <b>SELECT</b> buttons simultaneously for 5 seconds to let the UPS enter bypass mode. This action will be ineffective when the input voltage is out of the acceptable range.</li> </ul>

## 5.2 LCD Panel



Display	Function
<b>1 Remaining backup time information</b>	
	Indicates the remaining backup time in a pie chart.
	Indicates the remaining backup time in numbers. H: hour, M: minute, S: second
<b>2 Fault information</b>	
	Indicates that the warning/ fault occurs.
	Indicates the warning/ fault code. The code is listed in detail in <i>5.7 Fault Reference Code</i> .
<b>3 Mute operation</b>	
	Indicates that the UPS alarm is disabled.
<b>4 Output &amp; Battery voltage information</b>	
	Indicates the output voltage, frequency or battery voltage. Vac: output voltage, Vdc: battery voltage, Hz: output frequency
<b>5 Load information</b>	
	Indicates the load level by 0-25%, 26-50%, 51-75%, and 76-100%.
	Indicates overload.
	Indicates the load or the UPS output is short circuit.
<b>6 Mode operation information</b>	
	Indicates that the UPS connects to the mains.
	Indicates that the battery is working.

Display	Function
	Indicates that the bypass circuit is working.
	Indicates that the ECO mode is enabled.
	Indicates that the inverter circuit is working.
	Indicates that the output is working.
<b>7 Battery information</b>	
	Indicates the battery level by 0-25%, 26-50%, 51-75%, and 76-100%.
	Indicates that batteries have faults.
	Indicates low battery level and low battery voltage.
<b>8 Input &amp; Battery voltage information</b>	
	Indicates the input voltage, frequency or battery voltage. Vac: input voltage, Vdc: battery voltage, Hz: input frequency

### 5.3 Audible Alarm

Condition	Alarm
Battery Mode	Sounding every 4 seconds
Low Battery	Sounding every second
Overload	Sounding twice every second
Fault	Continuously sounding
Bypass Mode	Sounding every 10 seconds

## 5.4 LCD Display Wordings Index

Abbreviation	Display Content	Meaning
ENA	<i>ENR</i>	Enable
DIS	<i>DIS</i>	Disable
ESC	<i>ESC</i>	Escape
HLS	<i>HLS</i>	High loss
LLS	<i>LLS</i>	Low loss
BAT	<i>BAT</i>	Battery
CF	<i>CF</i>	Converter
TP	<i>TP</i>	Temperature
CH	<i>CH</i>	Charger
FU	<i>FU</i>	Bypass frequency unstable
EE	<i>EE</i>	EEPROM error

## 5.5 UPS Setting

There are three parameters to set up the UPS.

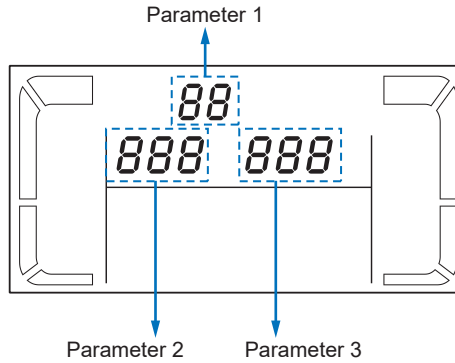

**Parameter 1:** It is for function selection. Refer to the table below.

**Parameter 2** and **Parameter 3** are the setting options or values for each program.

### 01: Output voltage setting

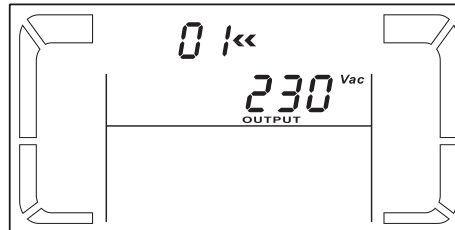

**Parameter 3:** Set the output voltage.

You may choose the following output voltage:

- 208:** presents output voltage 208 Vac
- 220:** presents output voltage 220 Vac
- 230:** presents output voltage 230 Vac (default)
- 240:** presents output voltage 240 Vac

## 02: Enable/ disable frequency converter

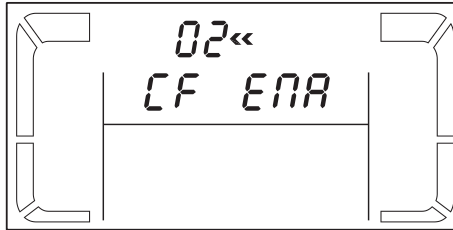

**Parameter 2 & 3:** Enable or disable frequency converter mode. You may choose the following two options.

**CF ENA:** enable frequency converter mode

**CF DIS:** disable frequency converter mode (default)

## 03: Output frequency setting

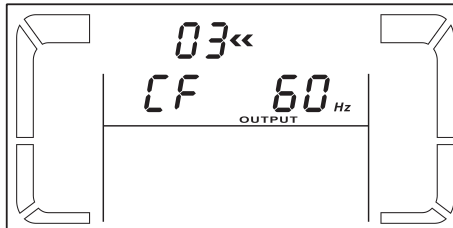

**Parameter 2 & 3:** Set the output frequency.

If the battery mode is enabled, you may choose the following initial frequency.

**BAT 50:** presents output frequency 50 Hz

**BAT 60:** presents output frequency 60 Hz

If the frequency converter mode is enabled, you may choose the following output frequency.

**CF 50:** presents output frequency 50 Hz

**CF 60:** presents output frequency 60 Hz

#### 04: Enable/ disable ECO

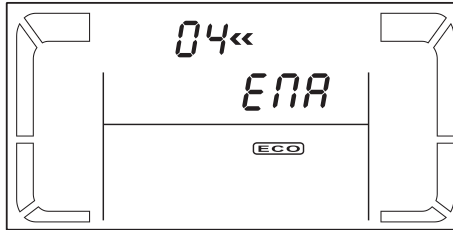

**Parameter 3:** Enable or disable ECO function. You may choose the following two options.

**ENA:** enable ECO mode

**DIS:** disable ECO mode (default)

#### 05: ECO voltage range setting

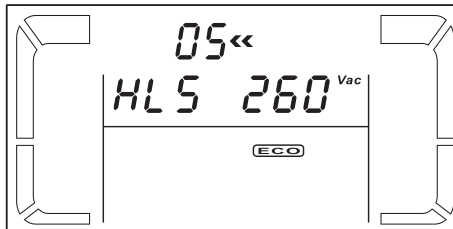

**Parameter 2 & 3:** Set an acceptable high voltage point and a low voltage point for ECO mode by pressing the **ON/ MUTE** or **SELECT** button.

**HLS:** High loss voltage in ECO mode in parameter 2.

The setting range in parameter 3 is from +7V to +24V of the nominal voltage (default: +12V).

**LLS:** Low loss voltage in ECO mode in parameter 2.

The setting range in parameter 3 is from -7V to -24V of the nominal voltage (default: -12V).

## 06: Enable/ disable bypass when the UPS is off

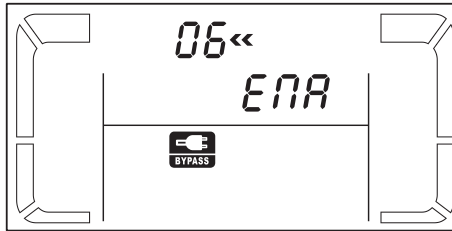

**Parameter 3:** Enable or disable bypass function. You may choose the following two options.

**ENA:** enable bypass

**DIS:** disable bypass (default)

## 07: Bypass voltage range setting

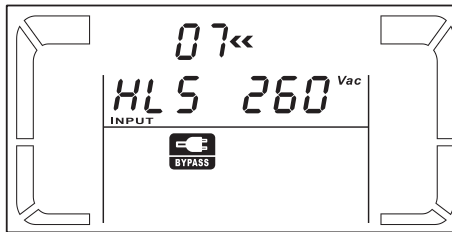

**Parameter 2 & 3:** Set an acceptable high voltage point and a low voltage point for bypass mode by pressing the **ON/ MUTE** or **SELECT** button.

**HLS:** Bypass high voltage point in parameter 2

230 ~ 264: the setting range in parameter 3 is from 230 Vac to 264 Vac (default: 264 Vac).

**LLS:** Bypass low voltage point in parameter 2

180 ~ 220: the setting range in parameter 3 is from 180 Vac to 220 Vac (default: 180 Vac).

## 08: Discharging time limitation

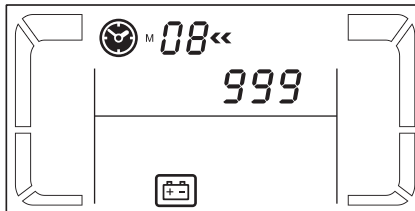

**Parameter 3:** Set the discharging time limitation in battery mode for general outlets.

**0 ~ 999:** Set the discharging time limitation in minutes from 0 ~ 999 for general outlets in battery mode.

**0:** When setting as "0", the discharging time will be only 10 seconds.

**999:** When setting as "999", the discharging time limitation will be disabled (default).

## 09: Total battery AH

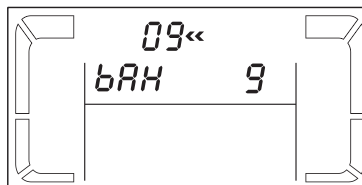

**Parameter 3:** Set the total battery Ah value of the UPS (unit: Ah).

**7 ~ 999:** Set the total battery capacity from 7 to 999. Please set this figure if the Delta external battery pack is connected.

If the UPS is standard runtime model, the default setting is 9 Ah.

If the UPS is extended runtime model, the default setting is 65 Ah.



### NOTE:

Do not change this setting for the UPS that does not have the external battery pack connector.

## 00: Exit Setting

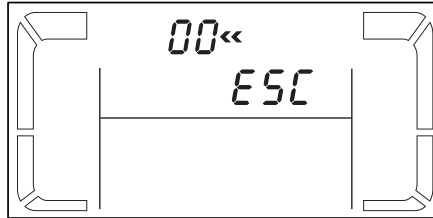

Exit the setting mode.

## 5.6 Operation Modes

- **Online Mode**

When the input voltage is within the acceptable range, the UPS will provide pure sine wave and stable AC power to output. The UPS will also charge the batteries in online mode.

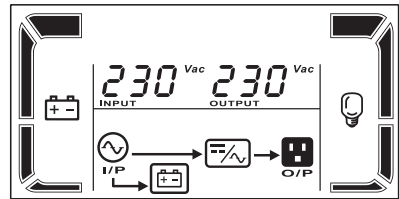

- **ECO Mode**

ECO mode is energy saving mode. When the input voltage is within the voltage regulation range, the UPS will run in bypass mode to supply power to output for energy saving.

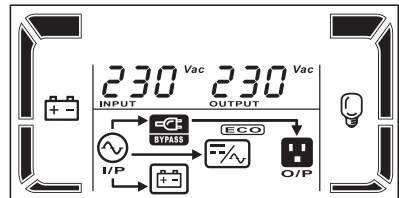

- **Frequency Converter Mode**

When the input frequency is between 40 Hz and 70 Hz, the UPS can be set at a constant output frequency, 50 Hz or 60 Hz. The UPS will still charge the batteries in this mode.

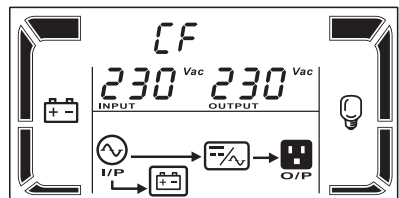

- **Battery Mode**

When the input voltage is beyond the acceptable range or a power failure occurs, the UPS will have backup power from the batteries and an alarm will sound every 4 seconds.

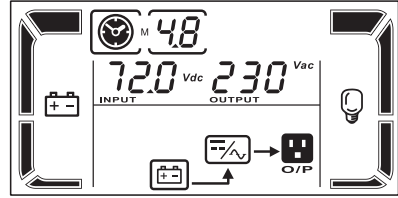

- **Bypass Mode**

When the input voltage is within the acceptable range but the UPS is overloaded, the UPS will enter bypass mode or bypass mode can be set via the front panel. The alarm will sound every 10 seconds.

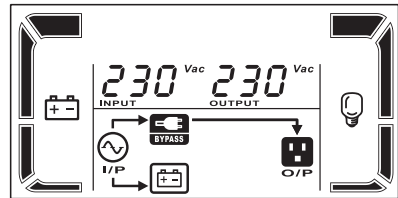

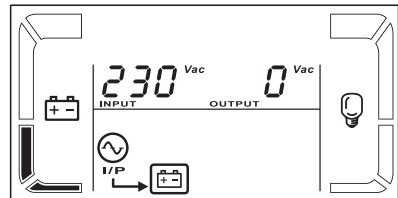

- **Standby Mode**

The UPS is powered off and there is no output, but the batteries can still be charged.













## 5.7 Fault Reference Code

Fault	Code	Icon
Bus start fail	01	X
Bus over	02	X
Bus under	03	X
Bus unbalance	04	X
Inverter soft start failure	11	X
Inverter voltage high	12	X
Inverter voltage low	13	X

Fault	Code	Icon
Inverter output short	14	
Battery voltage too high	27	
Battery voltage too low	28	
Over temperature	41	x
Overload	43	
Charger failure	45	x

## 5.8 Warning Indicator

Warning	Icon (flashing)	Alarm
Low battery		Sounding every second
Overload		Sounding twice every second
Battery is not connected		Sounding every second
Over charge		Sounding every second
Over temperature		Sounding every second
Charger failure		Sounding every second
Battery fault		Sounding every second
Out of bypass voltage range		Sounding every second
Bypass frequency unstable		Sounding every second
EEPROM error		Sounding every second

## Chapter 6 : Optional Accessories

There are several optional accessories available for this RT 1-3kVA series UPS. Please refer to the table below for the optional accessories and their functions.

No.	Item	Function
1	Mini SNMP IPv6 Card	Monitoring and control for the status of the UPS via a network system.
2	Mini Relay I/O Card	Increase of the dry contact number.
3	Mini MODBUS Card	Provision of the MODBUS communication function for the UPS.
4	Delta External Battery Pack	Provision of backup power to the UPS when power outages occur.
5	Rail Kit	Installation of the UPS in a rack.









### NOTE:

1. For detailed installation and operation of any accessory mentioned above, please refer to the **Quick Guide, User Manual or Installation & Operation Guide** included in the package of the relevant optional accessory.
2. If you want to buy any accessory mentioned above, please contact your local dealer or customer service.

# Chapter 7 : Troubleshooting

1. When a problem occurs, please check if the following situation exists before contacting Delta service personnel.
  - Is the main input voltage present?
2. Please have the following information ready if you would like to contact the Delta service personnel.
  - Unit information including model, serial number, etc.
  - An exact description of the problem; the more detailed, the better.
3. When you see the following problems occur, please refer to the solutions shown below.

Problem	Possible Cause	Solution
No indication and alarm even though the mains is normal.	The AC input power is not connected well.	Check if the input power cord firmly connected to the mains.
	The AC input is connected to the UPS output.	Plug the AC input power cord to the AC input correctly.
The icons  and  flash on the LCD display and the alarm sounds every second.	The external or internal batteries are incorrectly connected.	Check if all batteries are connected well.
The error code 27 or 28 appears, the icon  illuminates on the LCD display and the alarm sounds continuously.	Battery voltage is too high/ low or the charger is abnormal.	Contact your local dealer or customer service.

Problem	Possible Cause	Solution
<p>The icons  and  flash on the LCD display and the alarm sounds twice every second.</p>	<p>The UPS is overloaded.</p>	<p>Remove excess loads from the UPS output.</p>
	<p>The UPS is overloaded. Devices connected to the UPS are fed directly by the electrical network via the bypass.</p>	<p>Remove excess loads from the UPS output.</p>
	<p>After repetitive overloads, the UPS is locked in bypass mode. Connected devices are fed directly by the mains.</p>	<p>Remove excess loads from the UPS output first. Then, shut down the UPS and restart it.</p>
<p>The error code 43 appears, the icon  illuminates on the LCD display and the alarm sounds continuously.</p>	<p>The UPS shuts down automatically due to overload.</p>	<p>Remove excess loads from the UPS output and restart it.</p>
<p>The error code 14 appears, the icon  illuminates on the LCD display and the alarm sounds continuously.</p>	<p>The UPS shuts down automatically because short circuit occurs at the UPS output.</p>	<p>Check output wiring and inspect if connected devices are in short circuit status.</p>
<p>The error code 01, 02, 03, 04, 11, 12, 13, 41 or 45 appears on the LCD display and the alarm sounds continuously.</p>	<p>A UPS internal fault occurs. There are two possible results:</p> <ol style="list-style-type: none"> <li>1. The load is still supplied, but directly from AC power via bypass.</li> <li>2. The load is no longer supplied by the power.</li> </ol>	<p>Contact your local dealer or customer service.</p>

Problem	Possible Cause	Solution
Battery backup time is shorter than nominal value.	Batteries are not fully charged.	Charge the batteries for at least 5 hours and check the battery capacity. If the problem still exists, consult your dealer.
	Batteries are damaged.	Contact your dealer to replace the batteries.



**NOTE:**

If all possible causes listed above are eliminated but the problems still exist, please contact your local dealer or customer service.

# Chapter 8 : Maintenance



## NOTE:

Please ask your local dealer or customer service for more maintenance information. Do not perform maintenance if you are not trained for it.

- **UPS**

1. UPS Cleaning

Regularly clean the UPS, especially the slits, openings and filters (if any), to ensure that the air freely flows into the UPS to avoid overheating. If necessary, use an air blower to clean the slits and openings and replace the filters (if any) regularly to prevent any object from blocking or covering these areas.

2. UPS Regular Inspection:

- a. Monthly check the filters and regularly replace them (if any).
- b. Biannually check the UPS and inspect:
  - 1) Whether the UPS, LED indicators and alarm function normally.
  - 2) Whether the UPS works in bypass mode (normally, the UPS works in online mode). If yes, check if any error, overload, internal fault, etc. occur.
  - 3) Whether the battery voltage is normal. If the battery voltage is too high or too low, find the root cause.

- **Batteries**

The UPS uses lead-acid, lithium-ion or other batteries. Make sure to replace the batteries according to the battery life. The actual battery life depends on the environment temperature, usage, and charging/discharging frequency. High temperature environment and high charging/discharging frequency will quickly shorten the battery life; thus, battery inspection and maintenance are required periodically. Please follow the suggestions below to ensure normal battery life.

1. Keep the usage temperature at 20°C ~ 25°C (68°F ~ 77°F).
2. When the UPS needs to be stored for an extended period of time, the lead-acid batteries must be recharged once every three months and the charging time must not be less than 24 hours each time. As for the lithium-ion and other batteries, please contact your battery supplier for the charging frequency and charging duration. Regardless of battery type and whenever you recharge the batteries (internal or/ and external), please fully charge them until the Battery Level indicator  is fully on.



**NOTE:**

If the batteries need to be replaced, please contact qualified service personnel. During battery replacement, the loads connected to the UPS will not be protected if input power fails.

- **Fans**

Higher temperature will shorten fan life. When the UPS is running, please check if all fans work normally and make sure if air can move freely around and through the UPS. If not, please replace abnormal fans.

# Appendix 1: Technical Specifications

- Standard Runtime Model

Model		RT-1K	RT-2K	RT-3K
Capacity		1kVA/ 0.9kW	2kVA/ 1.8kW	3kVA/ 2.7kW
Input	Voltage Range	120 ~ 300 Vac (with derating to 50 ~ 100% load) 180 ~ 280 Vac (100% load)		
	Frequency Range	40 ~ 70 Hz		
	Phase	Single phase with ground		
	Power Factor	≥ 0.99 @ nominal voltage (100% load)		
Output	Nominal Voltage	208*1/220/230/240 Vac		
	Voltage Regulation	± 1% (battery mode)		
	Frequency Range (Online Mode)	50/60 Hz ± 3 Hz		
	Frequency Range (Battery Mode)	50/60Hz ± 0.5 %		
	Overload	Ambient temperature < 35°C (95°F) 105 ~ 109%: the UPS shuts down after 10 minutes in battery mode or transfers to bypass mode when the utility is normal. 110 ~ 129%: the UPS shuts down after 30 seconds in battery mode or transfers to bypass mode when the utility is normal. ≥ 130%: the UPS shuts down after 3 seconds in battery mode or transfers to bypass mode when the utility is normal.		

Model		RT-1K	RT-2K	RT-3K
Output (continued)	Short-circuit Current (RMS)	25A, 100 ms	50A, 100 ms	80A, 100 ms
	Current Crest Ratio	3:1 (max.)		
	Harmonic Distortion	≤ 3% THDv (linear load); ≤ 6% THDv (non-linear load)		
	Waveform (Battery Mode)	Pure sine wave		
Efficiency	Online Mode	88%	88%	90%
	ECO Mode	93%	94%	95%
Battery	Battery Type	12V/9Ah		
	Battery Voltage	24V	48V	72V
	Recharge Time	90% capacity recovery after 4 hours (typical)		
	Charging Current	1A		
Communication Interfaces		USB port*2/RS-232 port*2/Mini slot		
Compliance	IEC Pollution Degree (PD)	PD 2		
	Over Voltage Category (OVC)	OVC II		
	Type of System Earthing	TN-S, TN-C, TN-C-S		
Environment	Operating Temperature	0 ~ 50°C (32 ~ 122°F)*4		
	Operating Humidity	Relative humidity 10 ~ 90% (non-condensing)		

Model		RT-1K	RT-2K	RT-3K
Environment (continued)	Noise Level	≤ 50 dBA (1 m (3.28 ft))		
	Operating Altitude	0 ~ 3000 m (0 ~ 9842.52 ft)* <sup>5</sup>		
	Storage Temperature	-20 ~ 50°C (-4 ~ 122°F)		
	Storage Humidity	5 ~ 95%		
	Ingress Protection (IP) Class	IP20		
Physical	Dimensions (W × D × H)	438 × 310 × 86 mm (17.2" × 12.2" × 3.5")	438 × 410 × 86 mm (17.2" × 16.1" × 3.5")	438 × 630 × 86 mm (17.2" × 24.8" × 3.5")
	Weight	10.6 kg (24.03 lb)	17.9 kg (39.46 lb)	26.6 kg (58.64 lb)

- Extended Runtime Model

Model		RT-1K	RT-2K	RT-3K
Capacity		1kVA/ 0.9kW	2kVA/ 1.8kW	3kVA/ 2.7kW
Input	Voltage Range	120 ~ 300 Vac (with derating to 50 ~ 100% load) 180 ~ 280 Vac (100% load)		
	Frequency Range	40 ~ 70 Hz		
	Phase	Single phase with ground		
	Power Factor	≥ 0.99 @ nominal voltage (100% load)		

Model		RT-1K	RT-2K	RT-3K
<b>Output</b>	Nominal Voltage	208*1/220/230/240 Vac		
	Voltage Regulation	± 1% (battery mode)		
	Frequency Range (Online Mode)	50/60 Hz ± 3 Hz		
	Frequency Range (Battery Mode)	50/60Hz ± 0.5 %		
	Overload	<p>Ambient temperature &lt; 35°C (95°F)</p> <p>105 ~ 109%: the UPS shuts down after 10 minutes in battery mode or transfers to bypass mode when the utility is normal.</p> <p>110 ~ 129%: the UPS shuts down after 30 seconds in battery mode or transfers to bypass mode when the utility is normal.</p> <p>130 ~ 149%: the UPS shuts down after 3 seconds in battery mode or transfers to bypass mode when the utility is normal.</p> <p>≥ 150%: the UPS shuts down after 0.5 second in battery mode or transfers to bypass mode when the utility is normal.</p>		
	Short-circuit Current (RMS)	25A, 100 ms	50A, 100 ms	80A, 100 ms
	Current Crest Ratio	3:1 (max.)		
	Harmonic Distortion	≤ 3% THDv (linear load); ≤ 6% THDv (non-linear load)		
	Waveform (Battery Mode)	Pure sine wave		
<b>Efficiency</b>	Online Mode	88%	88%	90%
	ECO Mode	93%	94%	95%

Model		RT-1K	RT-2K	RT-3K
Battery	Battery Type	Depending on applications (optional Delta external battery pack is available)		
	Battery Voltage	36V	72V	72V
	Charging Current* <sup>3</sup>	1A/2A/4A/6A (default)		
Communication Interfaces		USB port* <sup>2</sup> /RS-232 port* <sup>2</sup> /Mini slot		
Compliance	IEC Pollution Degree (PD)	PD 2		
	Over Voltage Category (OVC)	OVC II		
	Type of System Earthing	TN-S, TN-C, TN-C-S		
Environment	Operating Temperature	0 ~ 50°C (32 ~ 122°F)* <sup>4</sup>		
	Operating Humidity	Relative humidity 10 ~ 90% (non-condensing)		
	Noise Level	≤ 50 dBA (1 m (3.28 ft))		
	Operating Altitude	0 ~ 3000 m (0 ~ 9842.52 ft)* <sup>5</sup>		
	Storage Temperature	-20 ~ 50°C (-4 ~ 122°F)		
	Storage Humidity	5 ~ 95%		
	Ingress Protection (IP) Class	IP20		

Model		RT-1K	RT-2K	RT-3K
Physical	Dimensions W × D × H	438 × 310 × 86 mm (17.2" × 12.2" × 3.5")	438 × 410 × 86 mm (17.2" × 16.1" × 3.5")	438 × 460 × 86 mm (17.2" × 18.1" × 3.5")
	Weight	5.7 kg (12.57 lb)	8.4 kg (18.52 lb)	8.9 kg (19.62 lb)



**NOTE:**

- \*<sup>1</sup>: The rated output power of the UPS will be de-rated to 70% when the output voltage is 208V.
- \*<sup>2</sup>: Do not use the RS-232 port and the USB port at the same time.
- \*<sup>3</sup>: Charging current can only be adjusted by qualified personnel.
- \*<sup>4</sup>: When the operating temperature is 40 ~ 50°C (104 ~ 122°F), the rated output power of the UPS needs to be de-rated to 70%.
- \*<sup>5</sup>: When the operating altitude is 2000 ~ 3000 m (6561.68 ~ 9842.52 ft), the rated output power of the UPS needs to be de-rated 1% for every 100 m (328.08 ft).
- Please refer to the rating label for the safety certification.
- All specifications are subject to change without prior notice.

## Appendix 2 : Warranty

Seller warrants this product, if used in accordance with all applicable instructions, to be free from original defects in material and workmanship within the warranty period. If the product has any failure problem within the warranty period, Seller will repair or replace the product at its sole discretion according to the failure situation.

This warranty does not apply to normal wear or to damage resulting from improper installation, operation, usage, maintenance or irresistible force (i.e. war, fire, natural disaster, etc.), and this warranty also expressly excludes all incidental and consequential damages.

Maintenance service for a fee is provided for any damage out of the warranty period. If any maintenance is required, please directly contact the supplier or Seller.



### **WARNING:**

The individual user should take care to determine prior to use whether the environment and the load characteristic are suitable, adequate or safe for the installation and the usage of this product. The User Manual must be carefully followed. Seller makes no representation or warranty as to the suitability or fitness of this product for any specific application.

## Global Headquarter

### Taiwan

Delta Electronics Inc.  
30 Section 2, Huandong Road, Shanhua District,  
Tainan City 74144, Taiwan  
T +886 6 505 6565  
E [ups.taiwan@deltaww.com](mailto:ups.taiwan@deltaww.com)

## Regional Office

### Netherlands

Delta Electronics (Netherlands) B.V.  
Zandsteen 15, 2132 MZ Hoofddorp, The Netherlands  
T +31 (0)20 800 3900  
E [info@delta-emea.com](mailto:info@delta-emea.com)

### Poland

Delta Electronics (Poland) Sp. z.o.o.  
23 Poleczki St., 02-822 Warszawa, Poland  
T +48 22 335 26 00  
E [ups.poland@deltaww.com](mailto:ups.poland@deltaww.com)

### Brazil

Delta Electronics Brasil Ltda.  
Estrada Velha Rio-São Paulo, 5300 – Eugênio de Melo –  
CEP 12247-001 São José dos Campos-SP-Brazil  
T +55 12 39322300  
E [ups.brazil@deltaww.com](mailto:ups.brazil@deltaww.com)

### Peru

Delta Electronics (Peru) Inc. S.R.L.  
Av. Pardo y Aliaga 699 Of. 601, San Isidro Lima, Peru.  
T +51 962 834 287  
E [ups.peru@deltaww.com](mailto:ups.peru@deltaww.com)

### China

Delta GreenTech (China) Co., Ltd.  
238 Minxia Road, Pudong, Shanghai, 201209 P.R.C  
T +86 21 5863 5678  
+86 21 5863 9595  
E [ups.china@deltaww.com](mailto:ups.china@deltaww.com)

### South Korea

Delta Electronics (Korea), Inc.  
1511, Byucksan Digital Valley 6-cha, Gasan-dong, Geumcheon-gu,  
Seoul, Korea, 153-704  
T +82-2-515-5303  
E [ups.south.korea@deltaww.com](mailto:ups.south.korea@deltaww.com)

### Thailand

Delta Electronics (Thailand) Public Co., Ltd.  
909 Soi 9, Moo 4, E.P.Z., Bangpoo Industrial Estate, Tambon Phraksa,  
Amphur Muang-samutprakarn, Samutprakarn Province 10280,  
Thailand  
T +662 709-2800  
E [ups.thailand@deltaww.com](mailto:ups.thailand@deltaww.com)

### Philippines

Eltek Power Inc./ Delta  
302 Orient Square Bldg  
F. Ortigas JR Road, Barangay  
San Antonio, Pasig City  
1605 Philippines  
E [ups.philippines@deltaww.com](mailto:ups.philippines@deltaww.com)

### Australia

Delta Electronics (Australia) Pty Ltd.  
St Leonard's Corporate Centre  
Unit 18/39 Herbert Street, St Leonards NSW 2065, Australia  
T +61 2 9479 4200  
E [ups.australia@deltaww.com](mailto:ups.australia@deltaww.com)

### UK

Delta Electronics (UK) Ltd.  
Eltek House, Unit 1 Cleveland Road, Hemel Hempstead,  
Hertfordshire, HP2 7EY, UK  
T +44 1442 210805  
E [sales.gb@eltek.com](mailto:sales.gb@eltek.com)

### U.S.A

Delta Electronics (Americas) Ltd.  
46101 Fremont Blvd. Fremont, CA 94538  
T +1 510 668 5100  
E [ups.na@deltaww.com](mailto:ups.na@deltaww.com)

### Colombia

Delta Electronics Colombia SAS  
Cra 72 # 95 – 51 Bodega 16, Parque Empresarial Los Lagartos  
Bogota DC, Colombia  
T +57 317 4052794  
E [ups.colombia@deltaww.com](mailto:ups.colombia@deltaww.com)

### India

Delta Electronics India Pvt. Ltd.  
Plot No. 43, Sector-35, HSIIDC, Gurgaon-122001,  
Haryana, India  
T +91 124 4874 900  
E [ups.india@deltaww.com](mailto:ups.india@deltaww.com)

### Japan

Delta Electronics (Japan), Inc.  
2-1-14 Shibadaimon, Minato-Ku, Tokyo, 105-0012,  
Japan  
T +81-3-5733-1111  
E [jpstps@deltaww.com](mailto:jpstps@deltaww.com)

### Singapore

Delta Electronics Int'l (Singapore) Pte Ltd.  
17 Kallang Junction, #01-01, TRION,  
Singapore 339274  
T +65 6747 5155  
E [ups.singapore@deltaww.com](mailto:ups.singapore@deltaww.com)

### Vietnam

Delta Electronics (Vietnam) Co., Ltd.  
6th floor Gems Empire Tower, No. 201 Truong Chinh  
street, Phuong Liet Ward, Ha Noi City, Vietnam  
T +84 974 766 198  
E [ups.vietnam@deltaww.com](mailto:ups.vietnam@deltaww.com)

### Indonesia

Delta Electronics International (S) Pte Ltd.  
Soho Capital, 30th Fl, Unit SC3009  
Jl. Letjend S. Parman kav 28. Jakarta 11470 Indonesia  
T + 65 9667 4687  
E [ups.indonesia@deltaww.com](mailto:ups.indonesia@deltaww.com)



Smarter. Greener. Together.