

Europe

Czech Republic

Delta Energy Systems
(Czech Republic), spol.s r.o.
Perucka 2482/7, 120 00 Praha 2,
Czech Republic
T +420 272 019 330
E ups.czech.republic@deltaww.com

Finland

Delta Solutions (Finland) Oy
P.O. Box 63, Juvan teollisuuskatu 15, FIN-
02921 Espoo, Finland
T +358 9 84966 0
E ups.finland@deltaww.com

France

Delta Electronics (France) S.A.
ZI du bois Chaland 2, 15 rue des Pyrénées,
Lisses, 91056 Evry Cedex, France
T +33 1 69 77 82 60
E ups.france@deltaww.com

Germany

Delta Energy Systems (Germany) GmbH
Coesterweg 45, 59494 Soest, Germany
T +49 2921 987 0
E ups.germany@deltaww.com

The Netherlands - EMEA Headquarters

Delta Electronics (Netherlands) BV
Zandsteen 15, 2132MZ Hoofddorp,
The Netherlands
T +31 (0) 20 800 39 00
E ups.netherlands@deltaww.com

Poland

Delta Electronics (Poland) Sp. z o.o.
23 Poleczki Str., 02-822 Warszawa,
Poland
T +48 22 335 26 00
E ups.poland@deltaww.com

Russia

Delta Energy Systems LLC
Vereyskaya Plaza II, office 112, Vereyskaya
str.17, 121357 Moscow, Russia
T +7 495 644 3240
E ups.russia@deltaww.com

Slovak Republic

Delta Electronics (Slovakia) s.r.o.
Botanicka 25/A, SK - 841 04 Bratislava,
Slovakia
T +421 2 6541 1258
E ups.slovakia@deltaww.com

Switzerland

Delta Electronics (Switzerland) AG
Freiburgstrasse 251, 3018 Bern-Bümpliz,
Switzerland
T +41 31 998 53 11
E ups.switzerland@deltaww.com

Spain

Delta Electronics Solutions (Spain) SLU.
Ctra. de Villaverde a Vallecas, 265 1º Dcha Ed.
Hormigueras, 28031 - Madrid, Spain
T +34 91223 7420
E ups.spain@deltaww.com

Turkey

Delta Greentech Electronic San. Ltd.
Serifali Mevkii Barboros Bulvari Soylesi Sok No
19 Y. Dudullu-Umraniye/Istanbul, Turkey
T +90 216 499 9910
E ups.turkey@deltaww.com

United Kingdom

Delta Electronics Europe Ltd.
1 Redwood Court, Peel Park, Campus, East
Kilbride, G74 5PF, United Kingdom
T +44 1355 588 888
E ups.united.kingdom@deltaww.com

Middle-East & Africa

South Africa

Delta Energy Systems MEA (Switzerland) AG
South Africa Representative Office
Unit 305B, Lougardia Building, Cnr
Embankment and Hendrik Verwoerd Drive,
Centurion, 0157, South Africa
T +27 12 663 2714
E ups.south.africa@deltaww.com

United Arab Emirates

Delta Energy Systems (Switzerland) AG
Dubai Representative Office
P.O. Box 185668
Gate 7, 3rd Floor, Hamarain Centre, Dubai
T +971 425 99 55 3
E info.middle-east@deltaww.com

Americas

Brazil

Delta Greentech (Brasil) S/A
Rua Itapeva, Nº 26 - 3º andar
01332 000 - São Paulo - SP
T +55 11 3530 8658
E ups.brazil@deltaww.com

The United States

Delta Electronics (Americas) Ltd.
46101 Fremont Blvd.
Fremont, CA 94538
T +1 510 344 2157
E ups.na@deltaww.com

Asia Pacific

Australia

Delta Electronics (Australia) Pty Ltd.
Unit 20-21, 45 Normanby Road, Notting
Hill VIC 3168, Australia
T +61 3 9543 3720
E ups.australia@deltaww.com
Sydney office:
B46/24-32 Lexington Drive, Bella Vista NSW 2153,
Australia

China

Delta GreenTech (China) Co., Ltd.
238 Minxia Road, Pudong, Shanghai, 201209
P.R.C
T +86 21 5863 5678 / +86 21 5863 9595
E ups.china@deltaww.com

India

Delta Power Solutions (India) Pvt. Ltd.
Plot No. 43, Sector-35, HSIIDC,
Gurgaon-122001, Haryana, India
T +91 124 4874 900
E ups.india@deltaww.com

Indonesia

Wisma Aldiron 1st Floor, Suite 140, Jl. Jend.
Gatot Subroto Kav. 72, Jakarta 12780,
Indonesia
E ups.indonesia@deltaww.com

South Korea

Delta Electronics (Korea), Inc.
1511, Byucksan Digital Valley 6-cha, Gasan-
dong, Geumcheon-gu, Seoul, Korea 153-704
T +82 2 515 5303
E ups.south.korea@deltaww.com

Malaysia

C-05-08, LEVEL05, BLOCK C, SKYPARK
One City, Jalan USJ 25/1
47650 Subang Jaya
Selangor Darul Ehsan, Malaysia
E ups.malaysia@deltaww.com

Philippines

Unit 1001 Richmond Plaza, San Miguel Ave.,
Ortigas Centre, Pasig City, Philippines
E ups.philippines@deltaww.com

Singapore

Delta Energy Systems (Singapore) Pte Ltd.
4 Kaki Bukit Ave 1, #05-04, Singapore
417939
T +65 6747 5155
E ups.singapore@deltaww.com

Taiwan

Delta Electronics Inc.
39 Section 2, Huandong Road,
Shanhua Township
Tainan County 74144, Taiwan
T +886 6 505 6565
E ups.taiwan@deltaww.com

Thailand

Delta Electronics (Thailand) Public Co., Ltd.
909 Soi 9, Moo 4, E.P.Z., Bangpoo
Industrial Estate, Tambon Prakasa,
Amphur Muang-samutprakarn,
Samutprakarn Province 10280, Thailand
T +662 709-2800
E ups.thailand@deltaww.com

Vietnam

3rd floor, RIC Building, 51 Hoang Viet, Tan Binh,
Ho Chi Minh City Vietnam
E ups.vietnam@deltaww.com



The power behind competitiveness

Delta InfraSuite Cast Resin Busway System

BR Series, 250A-1600A

www.deltapowersolutions.com



Delta Group

Leading expert in power management and thermal management solutions

Delta Group is the world's leading provider of power management and thermal management solutions, as well as a major source for components, visual displays, industrial automation, networking products, and renewable energy solutions. Delta Group is focused on three main businesses: power electronics, energy management, and smart green life. Delta Group has sales offices worldwide and manufacturing plants in Taiwan, China, Thailand, Japan, Mexico, India, Brazil and Europe.

As a global leader in power electronics, Delta's mission is, "To provide innovative, clean and energy-efficient solutions for a better tomorrow." Delta is committed to environmental protection and has implemented green, lead-free production and recycling and waste management programs for many years.

More information about Delta Group can be found at <http://www.deltaww.com/>

World no. 1 in Switching Power Supplies, DC Brushless Fans and Telecom Power Systems

163 sales offices and **39** manufacturing facilities worldwide

5%-6% of annual sales revenues invested in R&D with over **7,000** engineers in **64** R&D centers worldwide

Awarded **7,100+** patents and received **47** internationally recognized design awards including iF, Reddot, and the Taiwan Excellence awards.

No. 1 Supplier of Merchant Power Supplies

According to the IHS report, Delta Electronics remained the largest supplier of merchant power supplies with an estimated market share of 15.5% in 2016 of a global market value that was estimated to be \$21,869M.

The Total Merchant Power Supply Market 2016 \$M Revenue

Ranking	Company Name	Market Share
1	Delta Electronics	15.5%
2	Axxxxxn	7.5%
3	Lxxxxxx Technology	4.5 %

Source : AC-DC & DC-DC Merchant Power Supplies, IHS, 2017

Global Footprint

	Asia-Pacific (China)	Americas	EMEA	Total
Sales Offices	104 (61)	20	39	163
Plant Sites	32 (19)	4	3	39
R&D Centers	43 (23)	7	12	64

- Sales Offices
- Plant Sites
- R&D Centers



Awards

Delta Electronics outperformed 37 leading global companies in the Electronic Equipment, Instrument, and Component sector of the 2017 Dow Jones Sustainability Indexes (DJSI), and was selected for the DJSI World Index for the seventh consecutive year.

2007 - 2008
Forbes Asia's
Fabulous 50

2009
Frost & Sullivan Green
Excellence Award for
Corporate Leadership

2014
CPLI Climate Performance
Leadership Index, CPLI

MEMBER OF
**Dow Jones
Sustainability Indexes**
In Collaboration with RobecoSAM

2011 - 2015
Dow Jones
Sustainability Indexes

More information about Delta Group can be found at <http://www.deltaww.com/>

Mission Critical Infrastructure Solutions (MCIS)

With its expertise and experience in power management and energy efficiency, the Mission Critical Infrastructure Solutions (MCIS) business of Delta Electronics Inc. positions itself as: "The power behind competitiveness". MCIS plays an important role in making our customers' businesses more competitive. We fulfill this role by providing highly reliable and efficient power management products and data center infrastructure solutions to ensure the continuity of our customers' mission critical operations while reducing their Total Cost of Ownership (TCO). Delta MCIS is a powerful and trustworthy partner to companies that strive to outperform the competition.



Micro Data Center



Modular Data Center



Containerized Data Center



Power Container



DCIM



Cooling



AC Power



Converged Power



Precision Cooling

- Highly-efficient variable fan speed control saves 27% of power if fan speed reduced by 10%



InfraSuite Manager (DCIM)

- InfraSuite Manager integrates all facilities and IT equipment on one platform.
- InfraSuite Manager is Delta's fully featured DCIM software solution that optimizes data center performance and life cycle management.

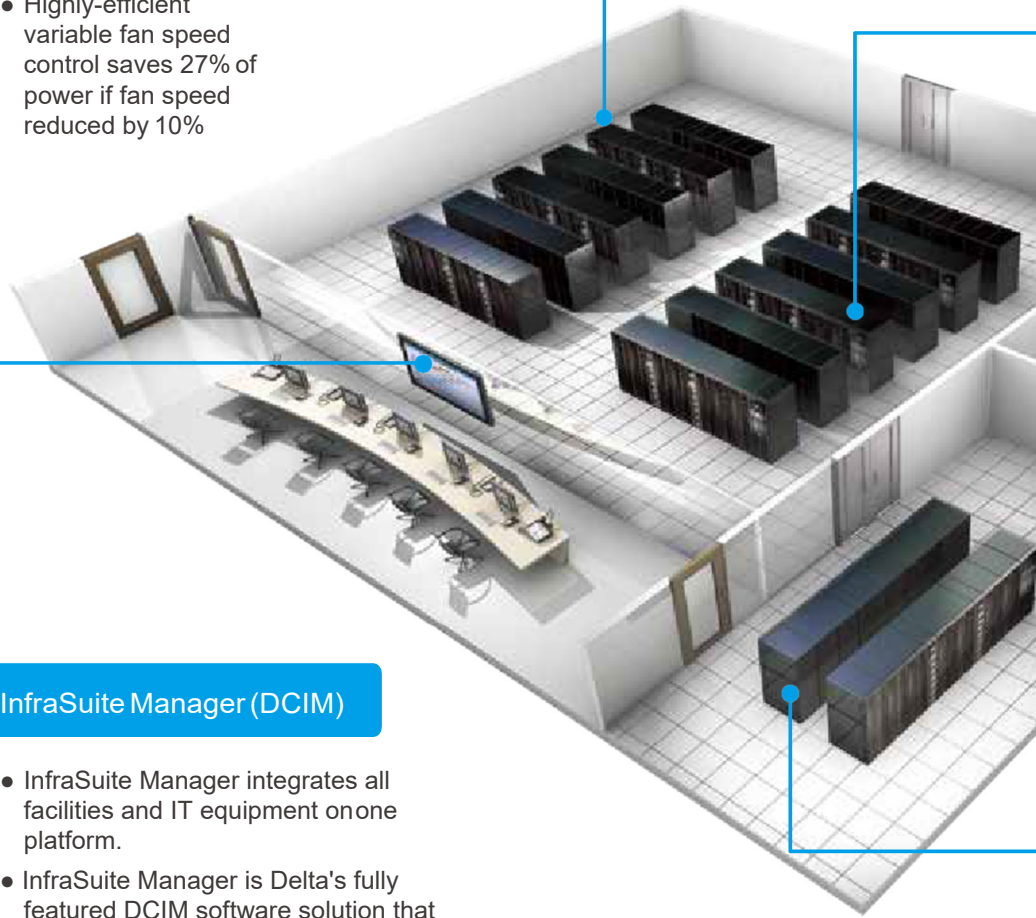

With more than 15 years of experience in the UPS industry, Delta Electronics is a leading brand, featuring complete professional capacities ranging from product development, design and manufacturing for all UPS product lines. Our client base covers world class enterprises in the areas of semiconductors, optoelectronics, food processing, finance, petrochemicals and telecommunications. Additionally, our UPS solutions have been adopted extensively at major Asia events in recent years, including the World Expo 2010 Shanghai, the Guangzhou Asian Games and Universiade Shenzhen, just to name a few. Delta's UPS solutions play a critical role in power management for a number of public mega projects, including One of the major transportation system in Taiwan, that has been rated number one in reliability by Nova/CoMet five years in a row since 2004, and the recently launched Target Spacecraft in China. The most competitive companies in the world choose Delta because our products are designed to enhance competitiveness.



Power Distribution System

- Power Distribution Unit (PDU): Modular and hot-swappable output breaker with transformer
- Rack Power Distribution Unit (rPDU): Reliable branch circuit breaker protection
- Remote Power Panel (RPP): PDU without transformer
- Rack-Mount Remote Power Panel (rRPP): An ideal power distribution solution to small data centers
- Busway: Safe, reliable and efficient power distribution solutions



UPS System

- Fully modular design. Hot-scalable and hot-swappable
- Output PF up to 1
- Leading power efficiency up to 96.5% for remarkable energy savings



Rack and Accessories

- Modular server racks with high perforation rate over 70% which increases heat dissipation
- Avoids cold and hot air mixture to significantly improve PUE < 1.5





Contents

- Product Introduction 2
- Data Center Application 3
- Customer Benefits 4
- Product Advantages 5 - 6
- Colors 7
- Technical Specification 8 - 9
- Plug-in Unit (Rv Series) 10 - 12
- Plug-in Unit (Rh Series) 13 - 14
- End Feed Box / End Cable Box 15
- Busway Configuration 16
- Monitoring Module 17

Delta Cast Resin Busway System

A Flexible, Safe, and Reliable Low Voltage Power Distribution Solution

With the brand vision “Smarter, Greener, Together,” Delta has utilized its industry-leading power electronics technology to develop the Busway BR Series for data center applications. Different from a conventional power cable system or sandwich busway solutions, Delta has adopted epoxy cast resin technology to significantly increase IP protection level, safety, and reliability. Delta's solution is ideal for use in a variety of industries and climate conditions. The superior electrical and mechanical characteristics of resin minimize the Busway BR Series' dimensions and simplify its structure. The Busway BR Series also has an extended product life cycle, increased reusability, and achieves significant energy savings for customers.

Customer Value

The Busway BR Series features:

- Successive plug-in slots are available for expansion and power distribution. Data centers can use them freely
- Ultra safe solution that satisfies the requirements of data centers
- Conforms to different standards, depending on market or customer needs, such as IEC, CNS and GB
- Space-saving and weight-saving solution that overcomes space and loading problems of the data center.
- Highly integrated composite materials that significantly reduce EMC and protect precision devices in the data center, and are safe for human health.

Delta's Busways vs, Traditional Cable

Delta's Busways excel over traditional cables in terms of safety, electrical properties, reliability, and scalability, making them the best choice for companies looking at optimum TCO.

	Cast Resin Busway System	Typical Power Distribution by Cables
System flexibility	Easily detaching joints, replaceable, re-usable and highly adaptable to system design changes	Need re-wiring in case of system changes
Installation and configuration	Quick installation and configuration	Wiring over premises, costly and time-consuming
Space use efficiency	Only 30% of traditional cable wiring, effective in saving installation space	Power distribution by cable needs PDU or RPP that occupies white space
Appearance	Easy to identify and manage at a glance	Messy power wiring, complicated looks
Fire resistance	High, IEC60331, BS6387	None
IP Rating	The protection level is primarily IP20 for data center applications. It can reach up to IP 55 per requirement	Not specified in the general technical data
Resistance to chemical and corrosion	Excellent	Poor
Instantaneous short-circuit strength	High	Low
Overload capacity (+25% 2hrs)	High	Low in heat resistance (up to about 60°C), thus being dangerous when overloaded, leading to accelerated insulating materials aging and reduced service life
Insulation rating	High, resin insulation Class F (155°C).	Low

Busway for Data Center Applications

With the recent wave of Big Data and IoT, data centers are responsible for more computing, communication and storage functions. In addition to the increase of their scope, the power density of a single rack cabinet has gradually increased. Effective space utilization is a great challenge for data center construction.

The Delta Cast Resin Busway System BR Series is exclusive for data center applications. Thanks to the epoxy insulation technology, it has a compact structure and size, as well as low EMC that allows it to overcome space limitations in server rooms. Data center designers can easily do wiring construction close to data cables without fear of an impact on their health due to low electromagnetic radiation.

In addition, the plug-in unit can be customized per customers' requirement. It is flexible for use with different power supply systems of server racks. The plug-in unit also applies the flexible successive plug-in slots and is hot swappable. Therefore, it is not constrained by data center space. Customers can carry out expansion or distribution anywhere, which is very flexible.

Busway Systems in Data Center

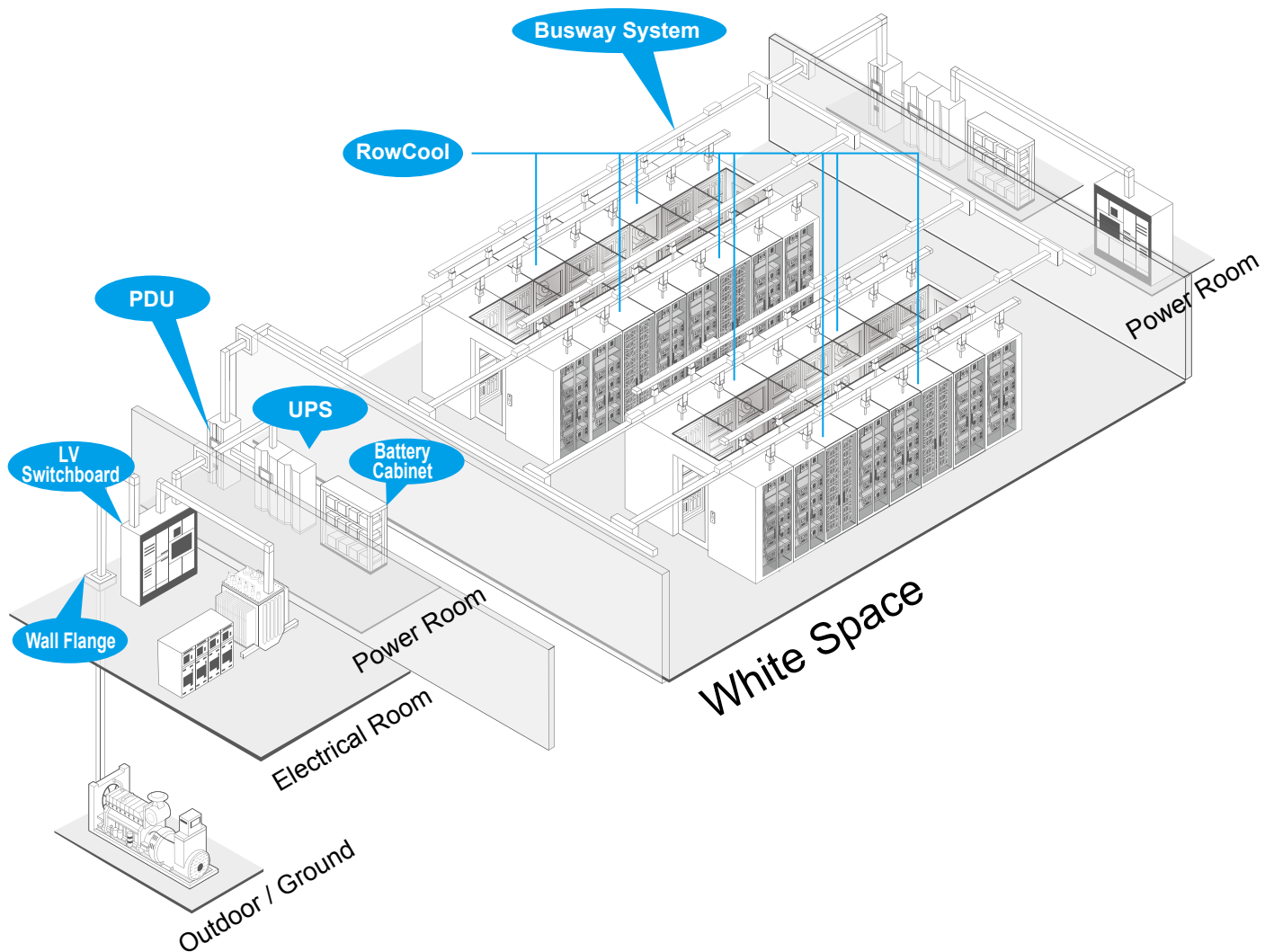

Customer Benefits

Safe, Reliable, Flexible and Efficient



Safe

The IP55 protection level provides water resistance and is dustproof. The busway remains highly reliable even in harsh environmental conditions, such as high humidity and dripping water. Delta has considered all aspects of the structure design.

- Installation: Attentive foolproof designs are available for every installation step
- Operation: Tool-less design for users to easily install plug-in units
- Compliant with IEC 61439, UL857



Reliable

The busway structure is an Aluminum housing. The busway adopts epoxy cast technology, which is filled and molded into one piece. Its advantages include:

- Minimizes risk from the stronger structure during lifting and assembly on data center sites
- Shield technology ensures optimum sequencing of the conductor. The integrated composite materials reduce EMC significantly and mitigate the interference to precision devices
- No maintenance is required



Efficient

The product design and installation uses many plug-ins and modular design concepts and is easy-to-use during the installation, operation and expansion phases.

Benefits of the successive plug-in slots and modular design are:

- Unconstrained by space or location, the busway can be designed effectively and installed without professional technicians
- The plug-in unit adopts a modular design that can be expanded simply and quickly
- Customers can save time on waiting for materials if there is any change in design
- Users can save time and costs on installation, expansion, and alteration

Product Advantages

Busway Body

- Wide power ratings ranging from 250A to 2000A
- Up to 200% neutral
- Highly integrated cast resin technology with epoxy inside
- Pole locations can be reserved or customer can choose the successive plug-in slots upon request
- Numerous standard lengths are available, such as 1M, 2M, 3M, 4M
- Length can be customized upon customer request
- IP protection level up to IP55



Plug-in Unit

- Easy expansion, plug and play and hot swappable without interruption
- No special tools required for installation
- Users can use a single module or multiple modules in parallel
- Highly customized plug-in units work with power meters and circuit breakers from major vendors
- Monitoring module is available for options

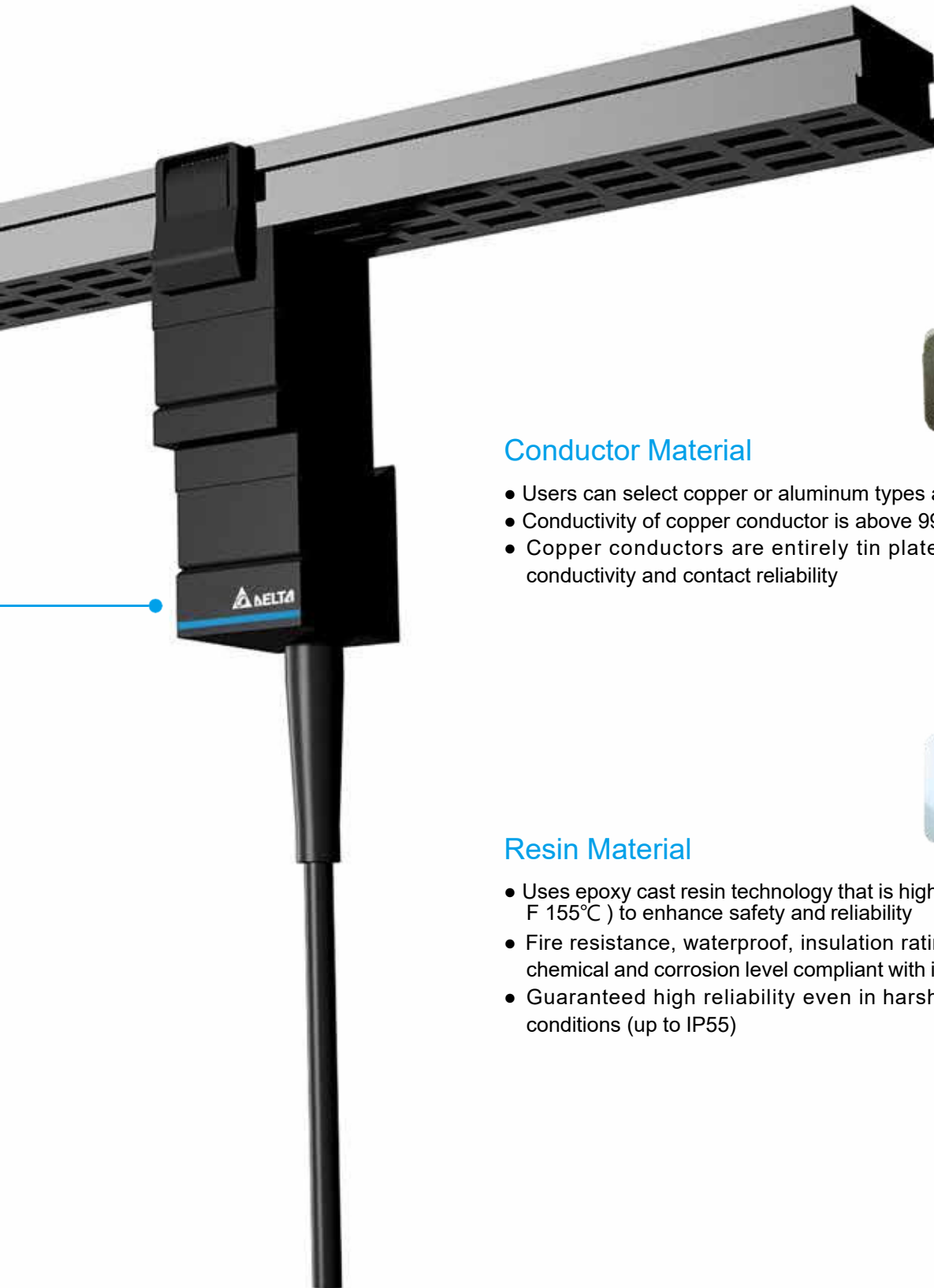

Conductor Material

- Users can select copper or aluminum types as needed
- Conductivity of copper conductor is above 99.9%
- Copper conductors are entirely tin plated for optimum conductivity and contact reliability



Resin Material

- Uses epoxy cast resin technology that is highly insulating (Class F 155°C) to enhance safety and reliability
- Fire resistance, waterproof, insulation rating, resistance to chemical and corrosion level compliant with industrial standards
- Guaranteed high reliability even in harsh environmental conditions (up to IP55)

Colors



Black (Std.)

Pantone
Color

Pantone
Black C



Dark Blue

Pantone
2146 C



Light Blue

Pantone
18-4538 TPG



Warm Red

Pantone
7621 C



Yellow

Pantone
Yellow C

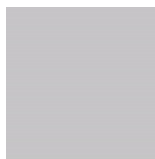

Grayish White

Pantone
Color

Pantone
13-4104 TPG

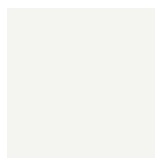

Bright White

Pantone
11-0601 TCX



Blue Green

Pantone
7717 C



Orange

Pantone
7577 C



Gray

Pantone
7538 C

Technical Specification

Busway Rating		250A	400A	600A	800A	1000A	1250A	1600A
Models	Copper	BRC02	BRC04	BRC06	BRC08	BRC10	BRC12	BRC16
	Aluminum	BRA02	BRA04	BRA06	BRA08	BRA10	BRA12	BRA16
Rated current	A	250	400	600	800	1000	1250	1600
Rated voltage	V	1000						
Frequency	Hz	50/60						
Conductor		Copper purity: 99.9% conductivity: 99.9% IACS Aluminum purity: 98.8% conductivity: 56.0% IACS						
Conductor plating		Tin plating (Std)						
Insulation material		Epoxy cast resin						
Insulation class		Class F (155°C)						
Enclosure/ housing		Epoxy/Aluminum						
Fire protection		UL94 V0						
Ingress protection rating		IP20 ; IP55 (optional)						
Mechanical Impact		IK10						
Earthquake test		0.8g [magnitude >7] ; Zone 4						
Plug-in Unit								
Contact design		Plug-in type						
Type		Rv: mounted to busway section vertically Rh: mounted to busway section horizontally						
Configuration		Plug-in unit w/ MCB/ELCB/RCBO Plug-in unit w/ MCB/RCB + Socket-outlets Plug-in unit w/ MCB/RCBO + Power Meter Plug-in unit w/ MCB + Over Temperature Detect System						
Max. Rating		400A						
MCCB brands		ABB(Std.), Mitsubishi, Fuji, GE, Schneider or Customer specified						
Ingress protection rating		IP20 ; IP42/55 (optional)						
Panel coating		Powder coated paint						
Color		RAL 9011/ RAL9003						
General Data								
Standards		IEC61439, IEC60529, IEC60331, IEC60332 CNS14286, CNS12514, CNS14165, CNS11073 UL857						
Ambient temperature		-20°C /+50°C avg. 35°C						
Altitude		Below 2000m from sea level						

Technical Specification

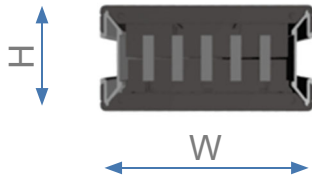

Copper

Busway Rating		250A	400A	600A	800A	1000A	1250A	1600A
Models		BRC02	BRC04	BRC06	BRC08	BRC10	BRC12	BRC16
Rated current	A	250	400	600	800	1000	1250	1600
Impedance values are for busway operating at 20/80°C temperature								
Resistance R_{20}	$\mu\Omega/m$	178.0	117.8	74.6	55.8	37.2	24.6	18.8
Resistance R_{80}	$\mu\Omega/m$	220.0	145.6	92.2	69.0	46.0	30.4	23.2
Reactance X_{50}	$\mu\Omega/m$	129.5	87.8	67.8	49.8	38.5	25.5	20.1
Impedance Z_{50}	$\mu\Omega/m$	255.3	170.0	114.4	85.1	60.0	39.7	30.7
Reactance X_{60}	$\mu\Omega/m$	155.4	105.3	81.3	59.8	46.2	30.6	24.1
Impedance Z_{60}	$\mu\Omega/m$	269.3	179.7	122.9	91.3	65.2	43.1	33.5
Conductor cross-section area								
L1,L2,L3	mm ²	72.5	145	232	307.4	464	696	928
N (100%)	mm ²	72.5	145	232	307.4	464	696	928
G (Internal)	mm ²	72.5	72.5	116	153.7	232	348	464
Busway Dimensions								
W x H	mm	117x58	117x58	117x73	117x86	117x113	117x153	117x193
Weight	Kg/m	13	15	23	32	46	59	65

Aluminum

Busway Rating		250A	400A	600A	800A	1000A	1250A	1600A
Models		BRA02	BRA04	BRA06	BRA08	BRA10	BRA12	BRA16
Rated current	A	250	400	600	800	1000	1250	1600
Impedance values are for busway operating at 20/80°C temperature								
Resistance R_{20}	$\mu\Omega/m$	213.0	122.0	93.5	62.6	49.7	41.8	25.4
Resistance R_{80}	$\mu\Omega/m$	263.2	150.8	115.5	77.4	61.4	51.7	31.4
Reactance X_{50}	$\mu\Omega/m$	138.1	100.0	59.8	46.7	40.8	32.7	19.0
Impedance Z_{50}	$\mu\Omega/m$	297.2	180.9	130.1	90.3	73.8	61.1	36.7
Reactance X_{60}	$\mu\Omega/m$	165.7	120.0	71.7	56.0	49.0	39.2	22.8
Impedance Z_{60}	$\mu\Omega/m$	311.0	192.7	136.0	95.5	78.6	64.8	38.8
Conductor cross-section area								
L1,L2,L3	mm ²	145	232	307.4	464	580	696	1160
N (100%)	mm ²	145	232	307.4	464	580	696	1160
G (Internal)	mm ²	72.5	116	153.7	232	290	348	580
Busway Dimensions								
W x H	mm	117x58	117x58	117x83	117x113	117x133	117x150	117x230
Weight	Kg/m	12	14	21	30	42	54	59

Note: Please contact Delta technician for the data of Voltage drop and Loss KW/M .

Plug-in Unit

RvS-S3P32-PO.02

PRODUCT CODE

Rv: VERTICAL BOX
Rh: HORIZONTAL BOX
ED: END FEED BOX

BOX CODE

S: SINGLE BOX
D: DOUBLE BOX
T: TRIPLE BOX

Output Loop CODE

S: SINGLE Loop
D: DOUBLE Loop
T: TRIPLE Loop

POLE NO.

1P
2P
3P (L1,L2,L3)
4P (L1,L2,L3,N)

AMPERAGE RATING

16
32
63

COMPONENT

P: POWER METER
O: SOCKET-OUTLETS
G: CABLE/PLUGS
E: Earth-Leakage CircuitBreakers
S: CAM SWITCHE

SERIAL NO.

Plug-in Unit (Rv Type)

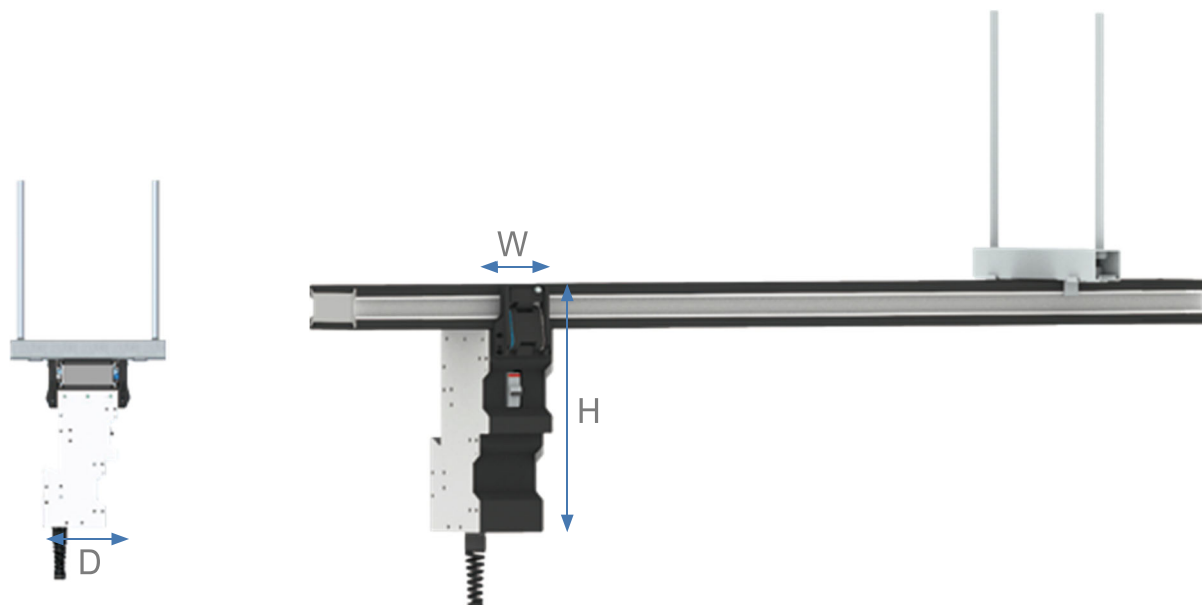

Rv type

Ratings		16A	32A	63A	125A	250A	400A
Height	mm	330	330	330	330	330	330
Depth	mm	165	165	165	165	165	165
Width	mm	100	100	100	200	300	300
IP Rating		IP42	IP42	IP42	IP42	IP42	IP42
Weight	kg	3	3	5	12	20	26

Standard Configurations for Plug-In Unit (Rv series)

RvS-S3P32-PO

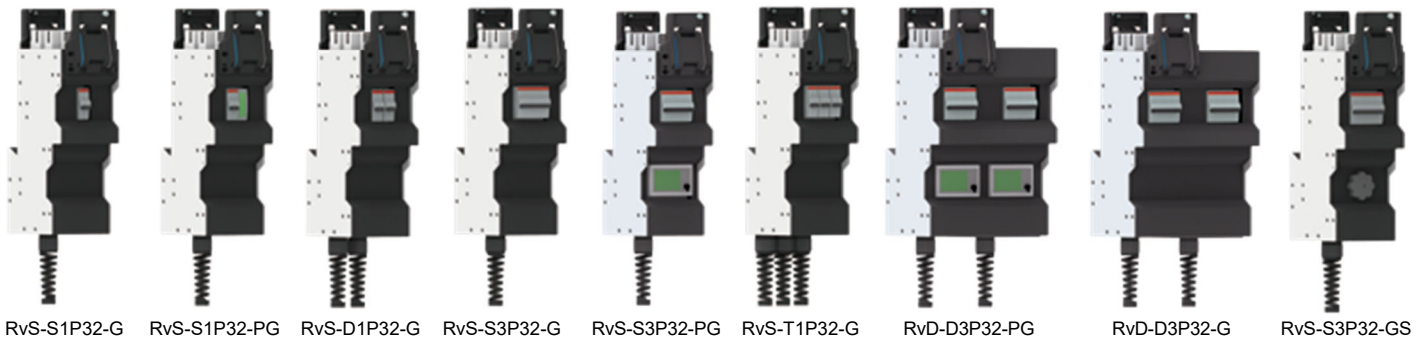
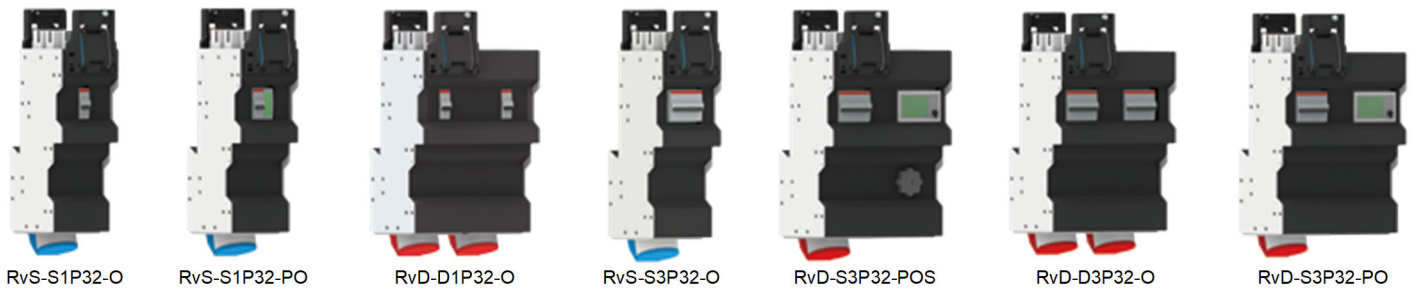
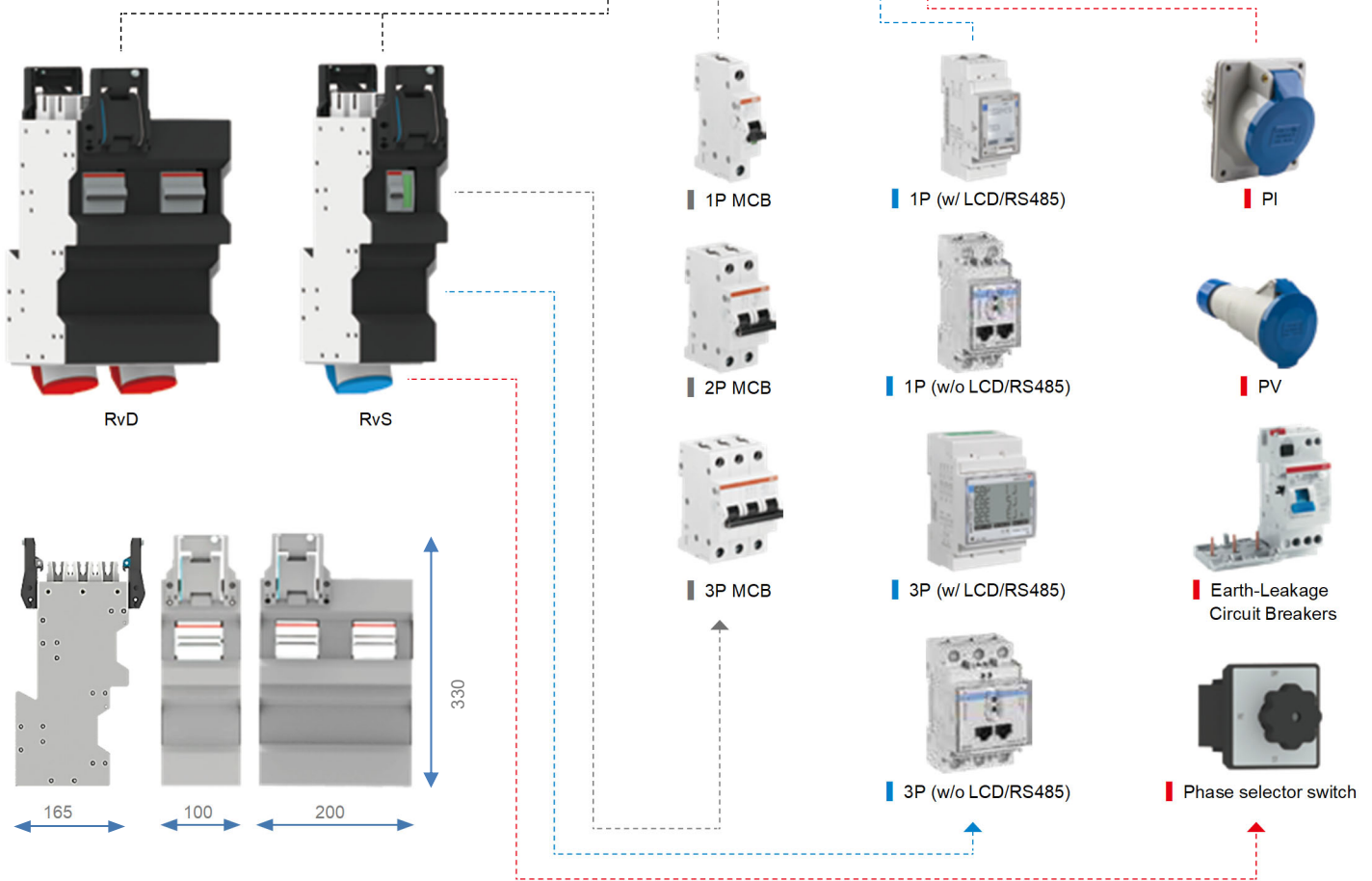

Plug-in Unit (Rh Type)

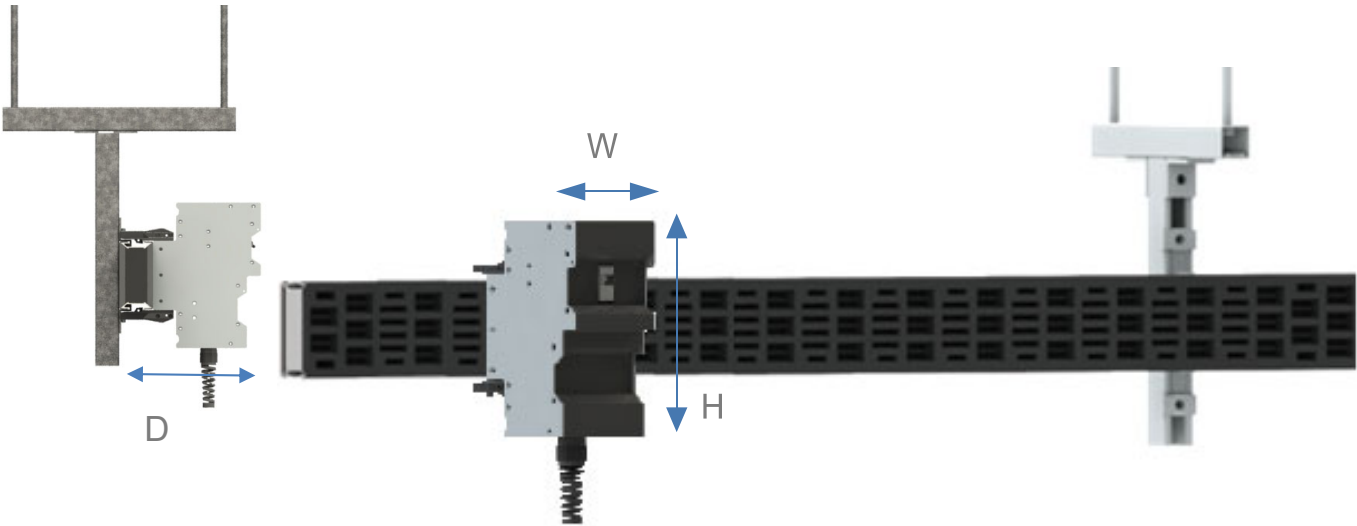

Rh type

Ratings		16A	32A	63A	125A	250A	400A
Height	mm	250	250	250	250	250	250
Depth	mm	243	243	243	243	243	243
Width	mm	100	100	100	200	300	300
IP Rating		IP42	IP42	IP42	IP42	IP42	IP42
Weight	kg	3	3	5	12	20	26

Standard Configurations for Plug-In Unit (Rh series)

RhS-S3P32-PO

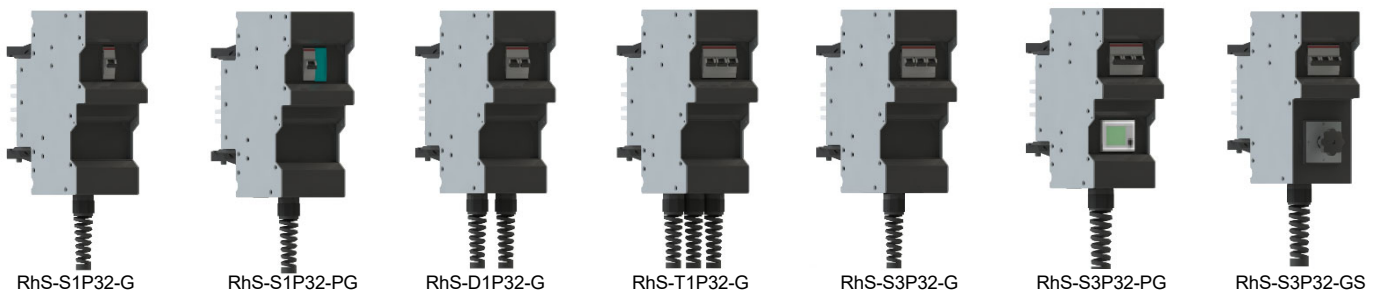
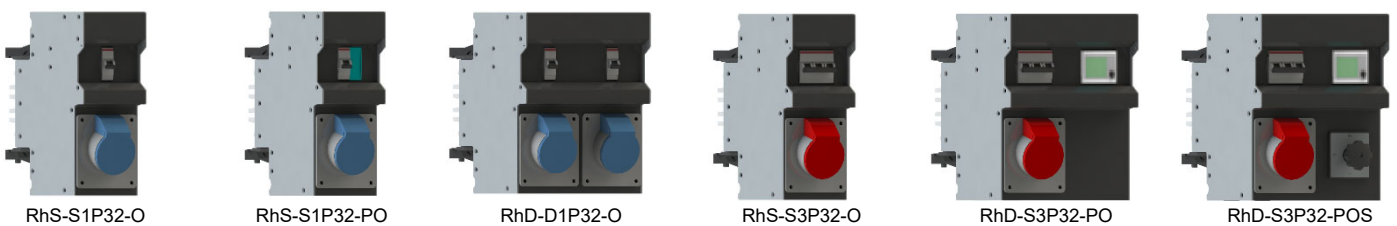
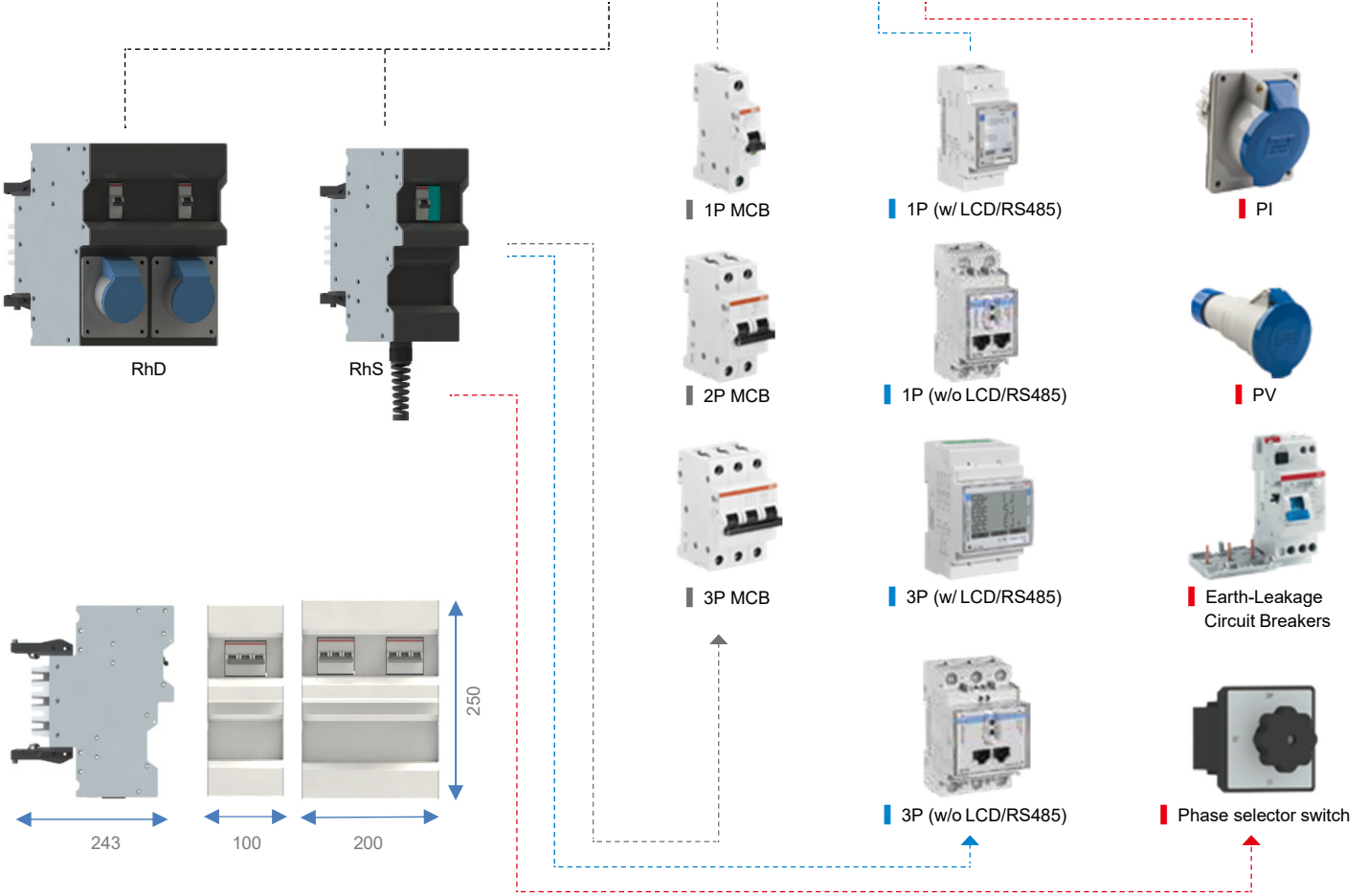

End Feed Box / End Cable Box

ECM-2506NF250CW-P

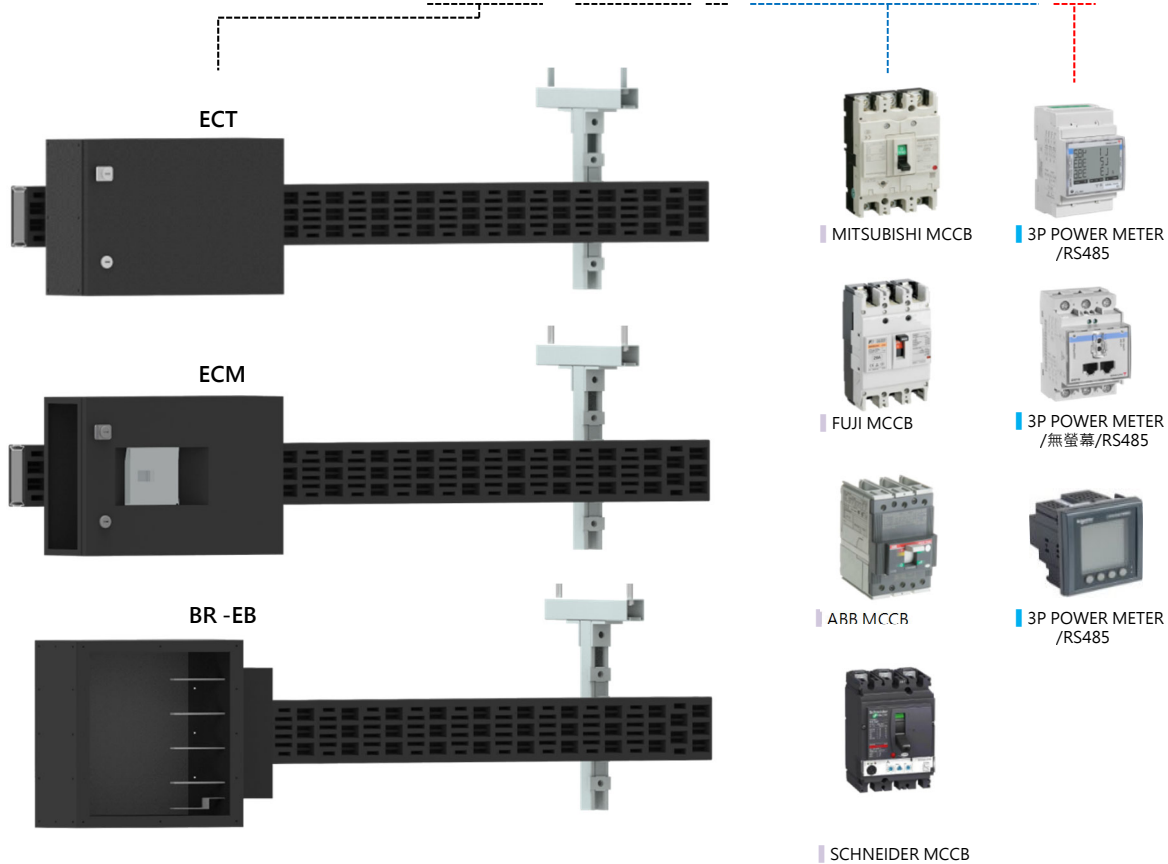

Ratings		250A		400A		630A		800A	1000A	1250A	1600A
Model (Type)		ECM-250 MCCB	ECT-250 Terminal	ECM-400 MCCB	ECT-400 Terminal	ECM-630 MCCB	ECT-630 Terminal	BRC086EB Terminal	BRC106EB Terminal	BRC126EB Terminal	BRC166EB Terminal
W	mm	480	430	480	430	480	430	500	500	500	500
H	mm	300	300	300	300	300	300	650	650	650	650
D	mm	240	160	240	160	240	160	220	233	260	300
IP Rating		IP42	IP42	IP42	IP42	IP42	IP42	IP42	IP42	IP42	IP42
Weight	Kg	17	15	19	15	20	17	35	38	45	55

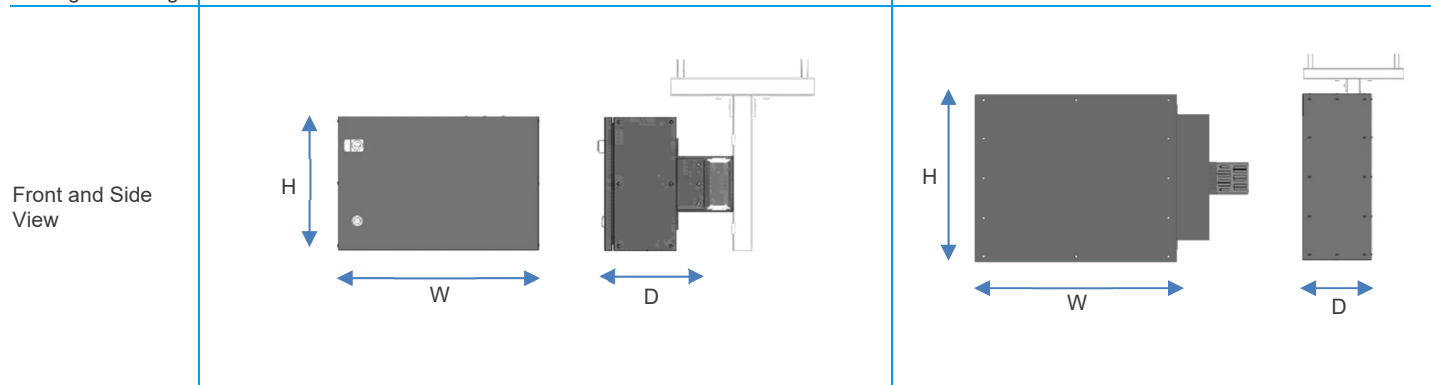

Busway Configuration



Feeder section



Plug-in section



Flatwise elbow



Edgewise elbow

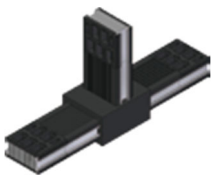

Flatwise Tee



Edgewise Tee



Flatwise Offset



Edgewise Offset



Flat to Edge Elbow



Edge to Flat Elbow

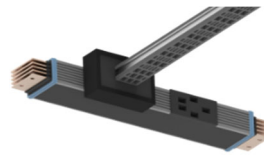

BL-BR plug-in section



BL-BR Plug-in section w/ PIU



Flatwise Tee

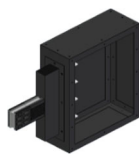

Edgewise Tee

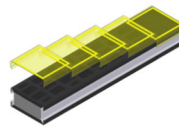

Slot Cover

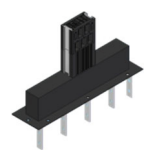

Flange End

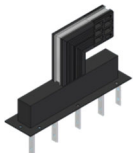

Flange End w/ Edgewise Elbow

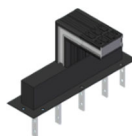

Flange End w/ Flatwise Elbow

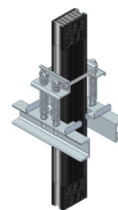

Spring Hanger

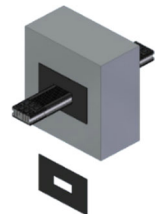

Wall/ Floor flange

Monitoring Module

The plug-in unit can fit within the monitoring module. The power information can be displayed or transmitted to the monitoring system via RS485.



InfraSuite Manager Data Center Infrastructure Management (DCIM)

Delta InfraSuite Manager is the fully featured Data Center Infrastructure Management (DCIM) software solution to deliver automation and visibility into the data center and increase the ease of management on a comprehensive platform. InfraSuite Manager optimizes the performance and life cycle management of the data center.

