



The power behind competitiveness

# Delta PQC Series Active Power Filter

New Generation Precise Filter Technology  
with Modular Design

[www.deltapowersolutions.com](http://www.deltapowersolutions.com)



# About Delta Group

Delta Group is the world's leading provider of power management and thermal management solutions, as well as a major source for components, visual displays, industrial automation, networking products, and renewable energy solutions. Delta Group focuses on three main businesses: power electronics, energy management, and smart green life. Delta Group has sales offices worldwide and manufacturing plants in Taiwan, China, Thailand, Japan, Mexico, India, Brazil, and Europe.

As a global leader in power electronics, Delta's mission is, "To provide innovative, clean and energy-efficient solutions for a better tomorrow." Delta is committed to environmental protection and has implemented green, lead-free production and recycling and waste management programs for many years.

More information about Delta Group can be found at [www.deltaww.com](http://www.deltaww.com)

## Delta's Quality

### Products - Delta's quality ensures customer satisfaction

Delta insists on the strictest quality control and management in various phases from development to manufacturing to ensure customer satisfaction by embracing the philosophy "Do things right the first time." Maintaining and exceeding the highest quality standards makes Delta the first-choice supplier of many world-leading enterprises.



2010  
Panasonic Electric Networks  
Certificate of Appreciation



2010  
Cisco  
Partner Collaboration  
Excellence Award



2008  
Fujitsu Siemens  
Computers Preferred  
Supplier Award



2008  
Nokia Siemens  
Outstanding Performance  
Award



2007~2008  
Fabulous 50  
Award



2007  
Intel  
Supplier Achievement Award



2007  
Rockwell  
Outstanding Performance  
Award



2005  
Siemens Communications  
Supplier of the Year Award



2004  
Cisco  
Supplier of the Year Award



2004  
Microsoft  
Vendor of the Year Award

## Delta's Manufacturing



Delta's Wujiang Plant is situated in the middle of the Yangtze River Delta, with Shanghai on the east, Taihu Lake on the west, the Suzhou downtown area on the north and Hangzhou on the South. Covering over 1000 acres, it is the largest manufacturing base for power quality and electronic products in China.

# Delta's Green Business

Delta was nominated as one of the "Global Top 100 Low-Carbon Emission Enterprises" by the CNBC European Business Magazine.

Delta has won the "Corporate Social Responsibility Award and Honorary Award" from Global Views Magazine for four consecutive years.

Delta has won the "Corporate Citizenship Award" from Common Wealth Magazine for three consecutive years.

Delta Group's mission statement focuses on social responsibility, "To provide innovative, clean and energy-efficient solutions for a better tomorrow." It also represents Delta confidence in putting advanced technology into practice for green IT.

Delta Group's president once said, "If Delta's power efficiency is improved by just 1%, there can be fewer power plants in the world."

# Delta's Technology

## Global Top 500 in Research and Development

Investing 5% of its annual operating revenue in R&D, Delta Group ranked No. 431 in a world ranking by the Department of Trade and Industry, United Kingdom.

IEEE selects three best theses every year to honor outstanding contributions to the academic fields of electrical and electronics engineering.

In September 2009, Delta's thesis "Performance Evaluation of Bridgeless PFC Boost Rectifiers" stood out from 313 theses and won the best thesis award issued by the IEEE. Chairman of the IEEE Prof. Feepak Divan (Right) presented the best thesis award to Milan M.Jovanovi, the manager of Delta's R&D center in USA.



# Power Quality and Harmonics

## Power Quality Issues Overview

Advanced power electronics equipment applications can improve our work efficiency and make life easier, but at the same time they can pollute the power grid. Rectifiers play a large part in many applications that are growing faster than power grid construction. Voltage and current harmonics, reactive power fluctuation, three phase imbalance, and other issues are caused by rectifiers with power quality issues that threaten the reliability and efficiency of the power supply system. Similarly, power voltage amplitude and frequency issues are affected by power generation.

We need to eliminate grid harmonics, reactive power fluctuations, imbalance, and other issues to adapt to new electronic equipment and power quality problems.



## Standard of Harmonics

For users and the electrical power system, power quality standards directly influence equipment function, life span, and efficiency, just as environment standards such as temperature, or altitude will affect equipment. Solving network power quality issues can improve equipment reliability, life span, and efficiency.

- Standard for Electrical Power System: Based on 《IEEE Recommended Practices and Requirements for Harmonic Control in Electrical Power Systems》 ( IEEE 519-2004 ) ,the grid voltage distortion limits:

Bus Voltage at PCC	Total Voltage Distortion (%)	Individual Voltage Distortion (%)
69 kV and below	5.0	3.0
69.001 kV through 161 kV	2.5	1.5
161.001kV and above	1.5	1.0

Current Distortion Limits for General Distribution Systems (120V Through 69000V) are shown as follows:

Table 10-□ Current Distortion Limits for General Distribution Systems (120 V Through 69 000 V)

Maximum Harmonic Current Distortion in Percent of $I_L$						
Individual Harmonic Order (Odd Harmonics)						
$I_{sc} / I_L$	< 11	$11 \leq h < 17$	$17 \leq h < 23$	$23 \leq h < 35$	$35 \leq h$	TDD
<20*	4.0	2.0	1.5	0.6	0.3	5.0
20<50	7.0	3.5	2.5	1.0	0.5	8.0
50<100	10.0	4.5	4.0	1.5	0.7	12.0
100<1000	12.0	5.5	5.0	2.0	1.0	15.0
>1000	15.0	7.0	6.0	2.5	1.4	20.0

Even harmonics are limited to 25% of the odd harmonic limits above.

Current distortions that result in a dc offset, e.g., half-wave converters, are not allowed.

\* All power generation equipment is limited to these values of current distortion, regardless of actual  $I_{sc}/I_L$ .

where  
 $I_{sc}$  = maximum short-circuit current at PCC.  
 $I_L$  = maximum demand load current (fundamental frequency component) at PCC.

# Delta Active Power Filter

## Product Overview

Delta PQC Series is an advanced modular active power filter (APF) system. Our highly reliable power quality products are based on the global R&D and large-scale production of Delta Group. The PQC Series is widely used in process industries such as cement, metal, chemicals and pharmaceuticals, as well as industries such as textiles, automobiles, health care, petrochemicals, datacenters, and more.

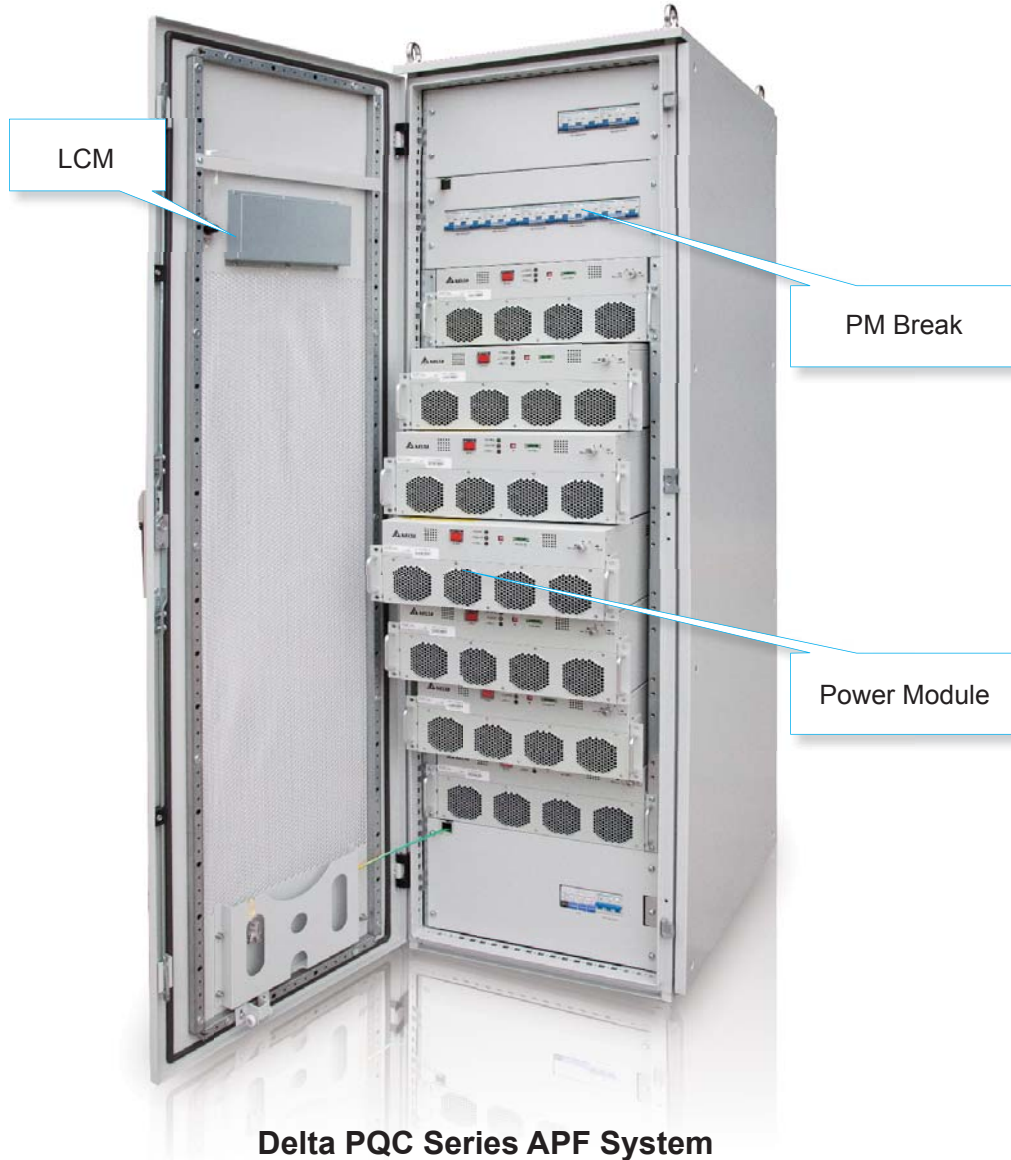

**Delta PQC Series APF System**

## Product Structure

The Delta PQC Series active power filter system is constructed of one or several filter modules, with an optional LCM system controller. The filter modules and LCM controller can be embedded in Delta's standard system cabinet or a third-party cabinet according to user requirements. CT terminations, C-class SPD and breakers are fixed in a standard cabinet, and the APF capacity can be configured according to user requirements. The filter capacity can be easily expanded at the user's site by plugging in filter modules. Each filter module can filter multi-selected harmonics simultaneously, with reactive power and imbalance compensation by DSP control.

# Delta Active Power Filter

## Operation Principle

The PQC Series APF has a parallel topology between grid side and load side, and can follow and compensate the dynamic harmonic current rapidly. In principle the APF measures harmonic current by CT, and actively calculates each order harmonic current by DSP FFT algorithms, and then it generates a current with phase that is opposite to the measured distorting harmonic current, which cancels out the original harmonics.

The PQC series APF not only eliminates harmonic current from the load side, but it also eliminates grid side harmonic voltage caused by harmonic current, as well as the harm caused by harmonic current and voltage. The APF system can also generate reactive power and imbalance compensation currents, which can cancel existing reactive power and imbalance currents in the system.

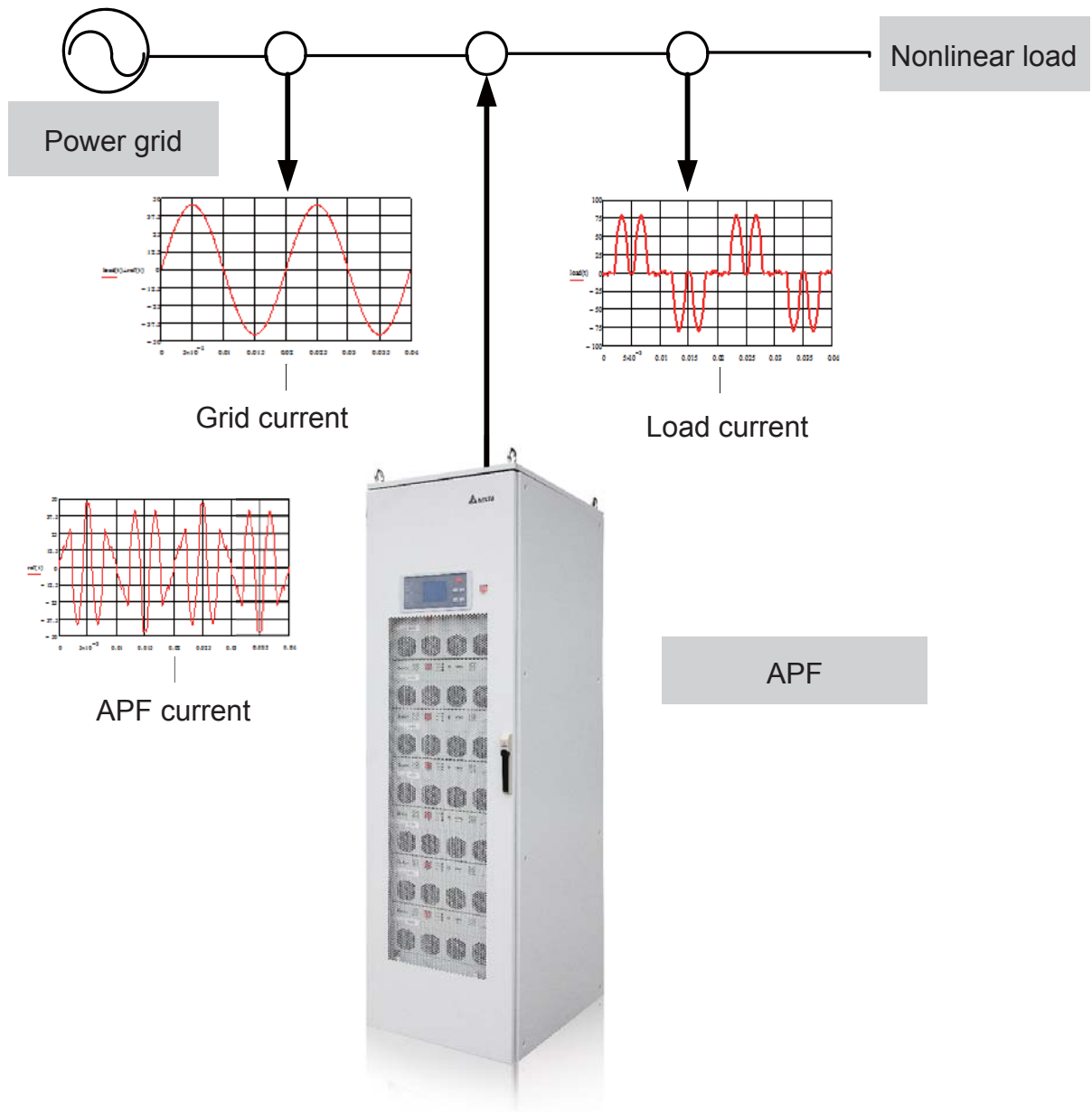

## Treatment Effect

Delta's PQC Series APF perfectly eliminates harmonic current and harmonic voltage caused by harmonic current, and ensures the THDu (Total Harmonic Distortion of grid Voltage) < 3%, the THDi (Total Harmonic Distortion of grid current) < 5% and the PF (Power Factor) > 95% with sufficient capacity and low background harmonics. It can also reduce losses and improve the reliability of the power supply system and can also reduce power off loss caused by power quality such as resonance.

PQC Application case: For communication IDC room, as below:

Grid current waveform, value and THDi before and after elimination (record by Fluke 435)

### 1. Waveform and value

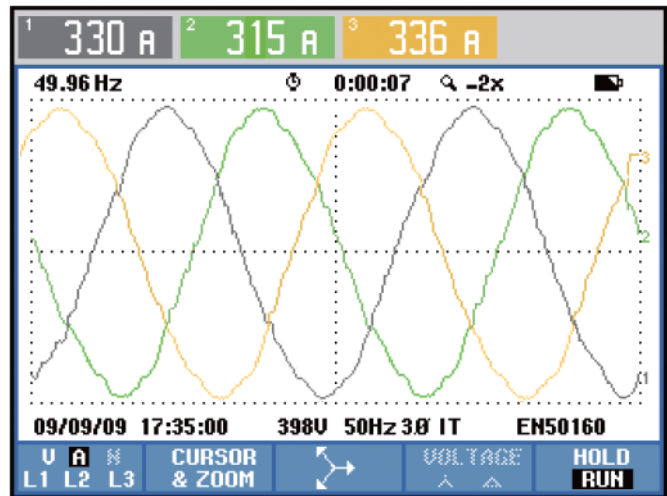
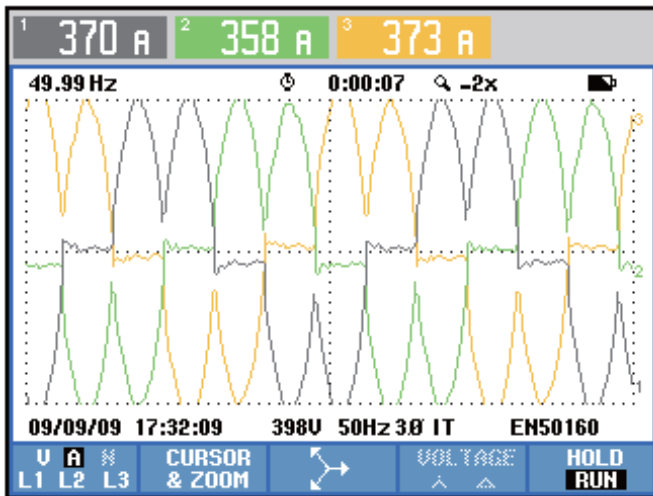

With APF treatment, the current waveform is corrected as sinusoidal and the current value is also reduced significantly.

### 2. THDi

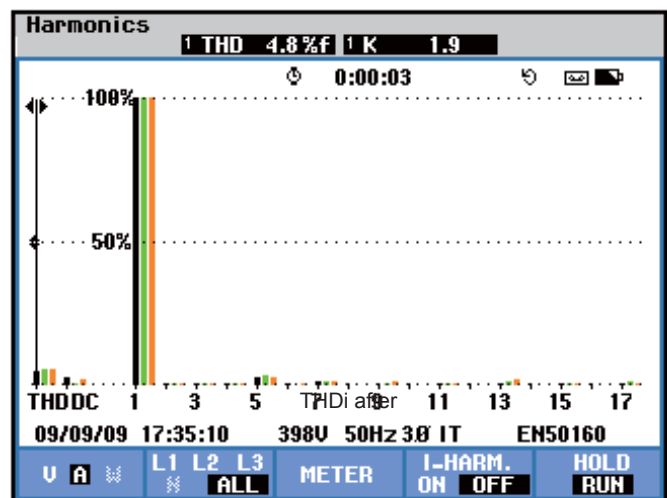
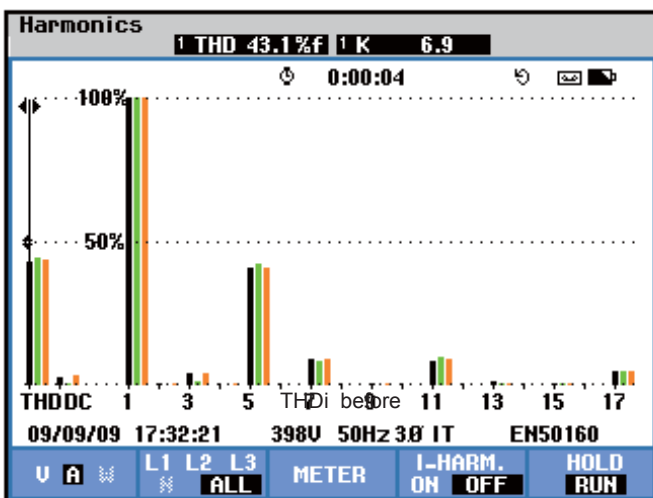

# Delta Active Power Filter

## System Selection

Delta's PQC Series APF can adapt to many application areas, such as industry, PDU rooms, or IDC rooms. Standard cabinet or third-party cabinets can be supplied according to various application environments, and capacity flexible configurations and easy expansion can be applied according to requirements. The PQC Series APF can provide maximum flexibility for system design, installation, maintenance, and it is easy to use.

### >> System naming rule

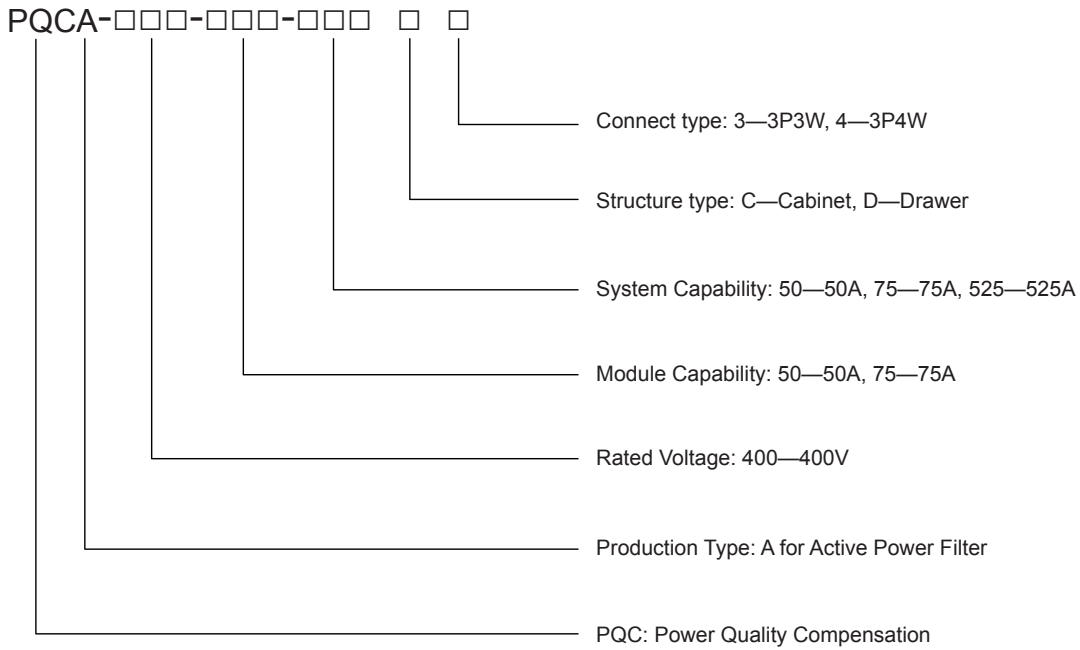

### >> Cabinet system overview

The cabinet system features a precise modular design, and filter capacity can be expanded by adding modules according to requirements. One module can provide 50A or 75A compensating current, and one cabinet system can provide up to 525A compensating current, which can be expanded by paralleling the cabinet system. It is easy to use at the design stage and maintenance stage for lower volume, flexible configuration, and convenient installation.





## >> Drawer system overview

The drawer system is for single-module configuration and usage, which applies to 3-level topology controlled by DSP, and consisting of high power electronics components with system protection. Each unit has communication ports and cooling fans for thermal dissipation, and can be embedded in a third-party cabinet.



## >> PQC Series APF system parameters

System Type	Capacity	Structure	Connection	Dimension	Weight
PQCA-400-50-50D3(4)	50A	Drawer	3P3W(3P4W)	513×602.5×180mm	41Kg
PQCA-400-75-75D3(4)	75A	Drawer	3P3W(3P4W)	513×602.5×180mm	51Kg
PQCA-400-50-50C3(4)	50A	Cabinet	3P3W(3P4W)	600×800×2000mm	237Kg
PQCA-400-75-75C3(4)	75A	Cabinet	3P3W(3P4W)	600×800×2000mm	247Kg
PQCA-400-75/50-125C3(4)	125A	Cabinet	3P3W(3P4W)	600×800×2000mm	279Kg
PQCA-400-75-150C3(4)	150A	Cabinet	3P3W(3P4W)	600×800×2000mm	289Kg
PQCA-400-75-225C3(4)	225A	Cabinet	3P3W(3P4W)	600×800×2000mm	331Kg
PQCA-400-75-300C3(4)	300A	Cabinet	3P3W(3P4W)	600×800×2000mm	373Kg
PQCA-400-75-375C3(4)	375A	Cabinet	3P3W(3P4W)	600×800×2000mm	415Kg
PQCA-400-75-450C3(4)	450A	Cabinet	3P3W(3P4W)	600×800×2000mm	457Kg
PQCA-400-75-525C3(4)	525A	Cabinet	3P3W/4W	600×800×2000mm	499Kg

Note: APF series can be re-configured based on the voltage conditions in the field and is also applicable under various distribution power system

These specifications are subject to change without notice. Please contact us or our distributors in your region for the latest specs

# Delta Active Power Filter

## Four Advantages of PQC Series APF

### 1. High Adaptability

The APF is widely used in a variety of applications and has proven to be highly adaptable to many environments, such as:

#### - Compatibility with diesel generators

A growing number of applications require a diesel generator for use as an emergency power supply, such as for communications, hospitals, banks, governments, precision manufacturing, as well as ambulatory working areas. Voltage and frequency constantly fluctuate when the diesel generator is operating, which causes some equipment to operate erratically, even with passive filters or capacitors. Delta's PQC Series APF has a wide range of input voltage, frequency and a fast response time, and is highly compatible with diesel generators.



**- Extreme electrical environments**

The APF provides power quality improvement and can adapt to the worst electric environments. Voltage THD can be as high as 15% in some industrial areas, along with serious reactive fluctuation. The Delta PQC Series products can adapt to such environments and can improve power quality issues. The APF can withstand high voltage THD (15%), and has C-class SPD to ensure proper operation and lightning protection.



**- Extreme physical environments**

The APF must also adapt to the worst physical environments. Temperatures in many industry areas exceed 40 °C. Equipment operating in such environments has a shorter life and is easily damaged. Corrosive gas will corrupt PCBs and components. Equipment may endure constant vibration for some applications. Delta's PQC Series products can operate normally at temperatures less than 50 °C, and have passed CCS authentication and Class-9 astigmatic test. The PQC Series adapts to environments with high temperatures, vibration, corrosion, or at high altitude.

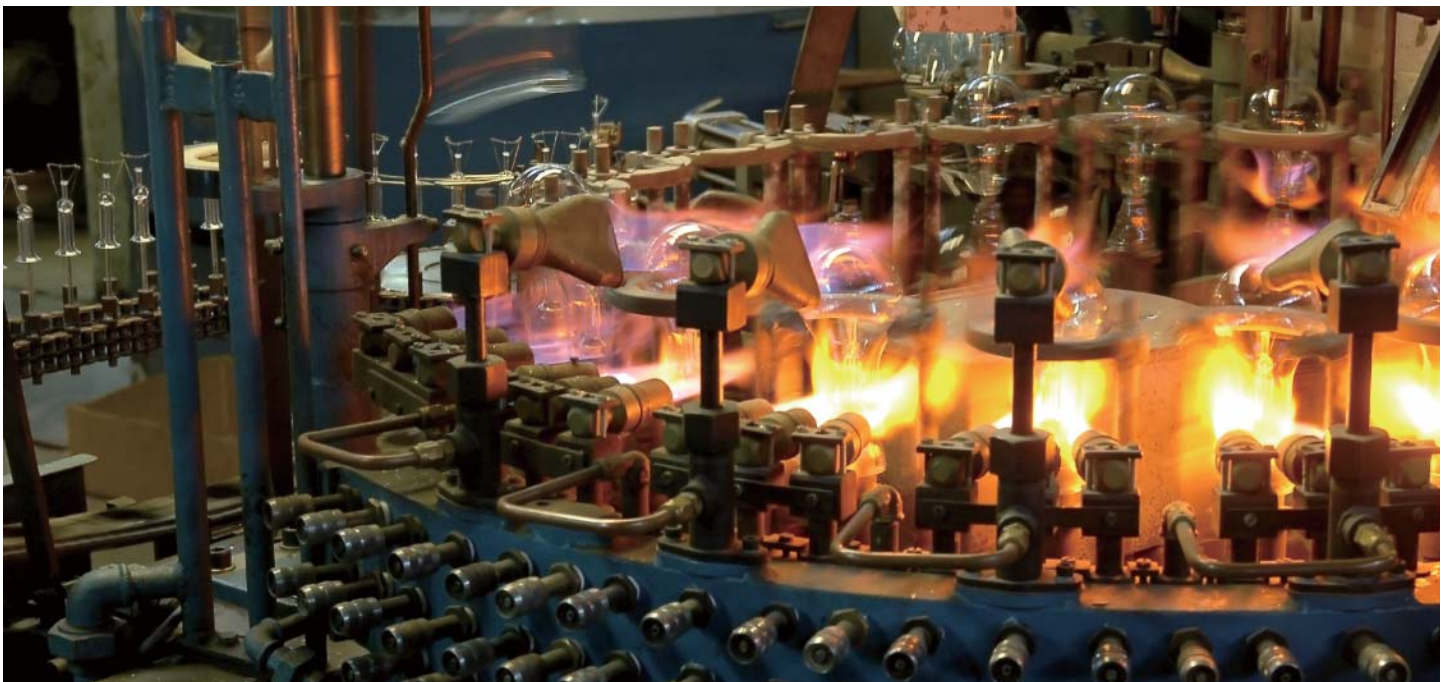

# Delta Active Power Filter

## 2. Simple and Flexible Application

- Flexible modular structure (Small footprint. Modular installation. Fully front operation. Easy plug-and-play)

The PQC Series APF is an easy to use system both for designers and users at both the design stage and maintenance stage. Designers have more choices with low volume and flexible configurations, which can save space. It allows use of both standard cabinets and third-party cabinets to support flexible configuration and capacity expansion. Installation and maintenance are much easier with plug-in operation and front fan replacement.



### 3. Superior Harmonic Elimination Capability

**- Applies 3-level topology and 60 KHz switching frequency**

The PQC Series APF adopts an advanced three level technology with many patents. Switching frequency can be designed as high as 60 kHz. The APF features include fast response speed, low thermal loss, no effect on loads and excellent adaptability, which ensures a wide filter range, and good EMC performance. The APF covers the harmonic order from 2 to 50 with 3 DSP controllers. The single elimination rate can reach as high as 97% to ensure filtering under various harmonic load applications.

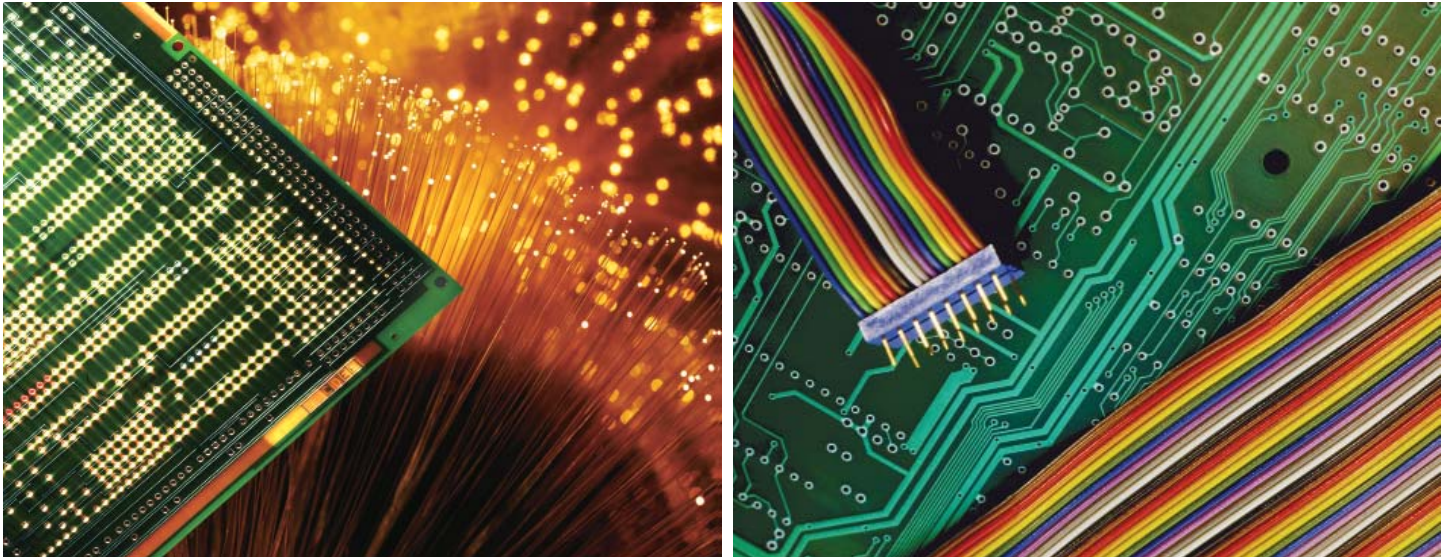

### 4. High Reliability

- IGBT parallel technology
- Intelligent air cooling technology
- International brand electronic device
- Advanced production technology



# Delta Active Power Filter

## Product Features

- Multifunctional: harmonic, reactive power, imbalance elimination
- High elimination rate: up to 97%
- Good reactive compensation: high speed (ms), precise ( $-0.99 < PF < 0.99$ )
- Bi-directional (capacitive and inductance) compensation
- Good imbalance compensation: imbalance compensation, neutral current compensation
- Wide grid voltage & frequency range, adapts to tough environment
- Low thermal loss ( $\leq 3\%$  rated power), efficiency  $\geq 97\%$
- High stability: infinite impedance for grid, no effect on grid impedance and other equipment
- Flexible application modular design, embedded in PDU cabinet
- Easy installation and maintenance: plug-in operation for exchange and expansion
- Large capacity range: 50A~525A for single cabinet, and 10 cabinets parallel
- High environment adaptability: 50°C temperature, pass Class-9 astigmatic test, operates with corrosive gas and diesel generator
- Full featured operation interface: event log, auto-alarm, fault record by EEPROM, parameter setting
- Function setting: auto self-diagnosis, soft start time setting, EPO



## Technical Specifications

Electrical	Rated Voltage	AC 400V +15% to - 20%
	Electric Connection	3P3W/3P4W
	Rated Frequency	50Hz (60Hz) +/- 10%
	Steady-state Voltage THD	<15%
	Harmonic Compensation Range	2 <sup>nd</sup> ~ 50 <sup>th</sup> order (selectable)
	Harmonic Compensation Degree	0 ~ 100% (selectable)
	Harmonic Elimination Rate	> 97%, grid side after elimination THDu< 3%, THDi< 5% *
	Reactive Power Compensation Capacity	Positive, Negative, Zero Sequence Reactive
	Full Response Time	< 20ms
	Instant Response Time	< 100us
	Thermal Loss	≤ 3%
	Output Current Restriction	Auto 100% rated current limitation
	Parallel Expansion (System)	Up to 10 racks (7 modules per rack)
	MTBF	> 100 thousand hours
	Control	Switching Frequency
Controller		3 DSPs control
Communication		Modbus Protocol, RS232/485
Connection		Fiber or Electric
Physical	Weight	Max Capacity < 500 kg
	IP Grade	IP20 or IP21 or Customization
	Cooling Method	Intelligent air cooling
	Noise	< 65dB(A) @1m (Module)
	Installation	Cabinet Type/Embedded Type
Environment	Ambient Temperature	-10~50 °C
	Relative Humidity (RH)	0~95% (non-condensing)
	Altitude	≤ 1000m rated capacity, 1000-2000m (derating 1% per 100m)

\* In condition of sufficient APF capacity and low background harmonics

## Europe

### Czech Republic

Delta Energy Systems (Czech Republic), spol.s r.o.  
Perucka 2482/7  
120 00 Praha 2  
Czech Republic  
T +420 272 019 330  
F +420 271 751 799

### Finland

Delta Energy Systems (Finland) Oy  
Juvan teollisuuskatu 15  
02921 Espoo  
T +358 9 84966 0  
F +358 9 84966 100

### France

Delta Energy Systems (France) S.A.  
ZI du bois Chaland 2 15 rue des Pyrenees,  
Lisses  
91056 Evry Cedex  
T +33 1 69 77 82 60  
F +33 1 64 97 05 77

### Germany

Delta Energy Systems (Switzerland) AG  
German Office  
Coesterweg 45, D-59494 Soest  
59494 Soest  
T +49 2921 987 337  
F +49 2921 987 396

### Italy

Delta Energy Systems (Italy) S.R.L.  
Piazza Grazioli 18  
00186 Roma  
T +39 06 699 41 209  
F +39 06 699 42 293

### The Netherlands

Deltronics Netherlands BV  
Zandsteen 15  
2132 MZ Hoofddorp  
The Netherlands  
T +31 20 655 0900  
F +31 20 655 0999

### Poland

Delta Energy Systems (Poland)  
Sp. z.o.o. 23 Poleczki Str.  
02-822 Warsaw  
T +48 22 335 26 00  
F +48 22 335 26 01

### Russia

Delta Energy Systems (Russia)  
Vereyskaya Plaza II, office 503,  
Vereyskaya str.17  
121357 Moscow, Russia  
T +7 495 644 32 40  
F +7 495 644 32 41

### Slovak Republic

DELTA ELECTRONICS (SLOVAKIA), s.r.o.  
Botanická 25/A, SR-841 04 Bratislava,  
T +421 (0)2 6541 1258  
F +421 (0)2 6541 1283

### Spain

Delta Energy Systems (Spain)  
S.L. Calle Luis I  
nº 60, Nave 1a, P.I. de Vallecas  
28031 Madrid  
T +34 91 223 74 20  
F +34 91 332 90 38

### Sweden

Delta Energy Systems (Sweden) AB  
P.O.Box 3096  
35033 Växjö  
T +46 470 70 68 16  
F +46 470 70 68 90

### Switzerland

Delta Energy Systems (Switzerland) AG  
Freiburgstrasse 251  
3010 Bern-Bümpliz  
T +41 31 998 53 11  
F +41 31 998 54 85

### Turkey

Delta Greentech Electronic San. Ltd.  
Sti. Serifali Mevkii Barbaros Bulvari Söylesi Sok.  
No: 19, K1, Y.Dudullu-Umraniye  
34775 Istanbul  
T +90 216 499 9910  
F +90 216 499 8070

### United Kingdom

Delta Electronics Europe Ltd.  
1 Redwood Court  
Peel Park, East Kilbride  
G74 5PF  
T +44 1355 588 888  
F +44 1355 588 889

## Americas

### Argentina

Delta Greentech  
Sarmiento 1889 5A  
Buenos Aires  
T +5411 4372 310

### Brazil

Delta Energy Systems (Brazil) S/A  
Rua Itapeva, Nº 26 - 3º andar  
01332 000 - São Paulo - SP  
T +55 11 3568 3874  
F +55 11 3568 3865

### Colombia

Delta Greentech  
Calle 213 # 114-10 manzana 14 casa 25  
Caminos de Arrayanes  
T +57 1 673 4927  
F +57 1 673 4927

## Middle-East & Africa

### South Africa

Delta Energy Systems MEA (Switzerland)  
AG South Africa Representative Office  
Unit 305B, Lougardia Building,  
Cnr Embankment and Hendrik Verwoerd  
Drive, Centurion,0157, South Africa  
T +27 12 663 2714  
F +27 86 667 0469

## Asia Pacific

### China

Delta GreenTech (China) Co., Ltd.  
No.238 Minxia Road, Pudong  
P.R.C 201209 Shanghai  
T +86 21 5863 5678  
+86 21 5863 9595  
F +86 21 5863 0003

### India

Delta Power Solutions (India) Pvt. Ltd.  
Plot No. 43, Sector-35, HSIIDC,  
Gurgaon-122001, Haryana, India  
T +91 124 4874 900  
F +91 124 4874 945

### Taiwan

Delta Electronics Inc.  
39 Section 2, Huandong Road, Shanhua  
Township  
Tainan County 74144, Taiwan  
T +886 6 505 6565  
F +886 6 505 1919

### Australia

Delta Energy Systems Australia Pty Ltd.  
Unit 20-21, 45 Normanby Road, Notting  
Hill VIC 3168, Australia  
T +61 3 9543 3720  
F +61 3 9544 0606

### Thailand

Delta Electronics (Thailand) Public Co., Ltd.  
909 Soi 9, Moo 4, E.P.Z., Bangpoo  
Industrial Estate, Tambon Prakasa,  
Amphur Muang-samutprakarn,  
Samutprakarn Province 10280, Thailand  
T +662 709-2800  
F +662 709-2833

### Singapore

Delta Electronics Int'l (Singapore) Pte Ltd.  
4 Kaki Bukit Ave 1, #05-04, Singapore  
417939  
T +65 6747 5155  
F +65 6744 9288