

Europe

Czech Republic

Delta Energy Systems
(Czech Republic), spol.s r.o.
Perucka 2482/7, 120 00 Praha 2,
Czech Republic
T +420 272 019 330
E ups.czech.republic@deltaww.com

Finland

Delta Solutions (Finland) Oy
P.O. Box 63, Juvan teollisuuskatu 15, FIN-
02921 Espoo, Finland
T +358 9 84966 0
E ups.finland@deltaww.com

France

Delta Electronics (France) S.A.
ZI du bois Chaland 2, 15 rue des Pyrénées,
Lisses, 91056 Evry Cedex, France
T +33 1 69 77 82 60
E ups.france@deltaww.com

Germany

Delta Energy Systems (Germany) GmbH
Coesterweg 45, 59494 Soest, Germany
T +49 2921 987 0
E ups.germany@deltaww.com

The Netherlands - EMEA Headquarters

Delta Electronics (Netherlands) BV
Zandsteen 15, 2132MZ Hoofddorp,
The Netherlands
T +31 (0) 20 800 39 00
E ups.netherlands@deltaww.com

Poland

Delta Electronics (Poland) Sp. z.o.o.
23 Poleczki Str., 02-822 Warszawa,
Poland
T +48 22 335 26 00
E ups.poland@deltaww.com

Russia

Delta Energy Systems LLC
Vereyskaya Plaza II, office 112, Vereyskaya
str.17, 121357 Moscow, Russia
T +7 495 644 3240
E ups.russia@deltaww.com

Slovak Republic

Delta Electronics (Slovakia) s.r.o.
Botanicka 25/A, SK - 841 04 Bratislava,
Slovakia
T +421 2 6541 1258
E ups.slovakia@deltaww.com

Switzerland

Delta Electronics (Switzerland) AG
Freiburgstrasse 251, 3018 Bern-Bümpliz,
Switzerland
T +41 31 998 53 11
E ups.switzerland@deltaww.com

Spain

Delta Electronics Solutions (Spain) SLU.
Ctra. de Villaverde a Vallecas, 265 1º Dcha Ed.
Hormigueras, 28031 - Madrid, Spain
T +34 91223 7420
E ups.spain@deltaww.com

Turkey

Delta Greentech Electronic San. Ltd.
Serifali Mevkii Barboros Bulvari Soylesi Sok No
19 Y.Dudullu-Umraniye/Istanbul, Turkey
T +90 216 499 9910
E ups.turkey@deltaww.com

United Kingdom

Delta Electronics Europe Ltd.
1 Redwood Court, Peel Park, Campus, East
Kilbride, G74 5PF, United Kingdom
T +44 1355 588 888
E ups.united.kingdom@deltaww.com

Middle-East & Africa

South Africa

Delta Energy Systems MEA (Switzerland) AG
South Africa Representative Office
Unit 305B, Lougardia Building, Cnr
Embankment and Hendrik Verwoerd Drive,
Centurion, 0157, South Africa
T +27 12 663 2714
E ups.south.africa@deltaww.com

United Arab Emirates

Delta Energy Systems (Switzerland) AG
Dubai Representative Office
P.O. Box 185668
Gate 7, 3rd Floor, Hamarain Centre, Dubai
T +971 425 99 55 3
E info.middle-east@deltaww.com

Americas

Brazil

Delta Greentech (Brasil) S/A
Rua Itapeva, Nº 26 - 3º andar
01332 000 - São Paulo - SP
T +55 11 3530 8658
E ups.brazil@deltaww.com

The United States

Delta Electronics (Americas) Ltd.
46101 Fremont Blvd.
Fremont, CA 94538
T +1 510 344 2157
E ups.na@deltaww.com

Asia Pacific

Australia

Delta Energy Systems Australia Pty Ltd.
Unit 20-21, 45 Normanby Road, Notting
Hill VIC 3168, Australia
T +61 3 9543 3720
E ups.australia@deltaww.com
Sydney office:
B46/24-32 Lexington Drive, Bella Vista NSW 2153,
Australia

China

Delta GreenTech (China) Co., Ltd.
238 Minxia Road, Pudong, Shanghai, 201209
P.R.C
T +86 21 5863 5678 / +86 21 5863 9595
E ups.china@deltaww.com

India

Delta Power Solutions (India) Pvt. Ltd.
Plot No. 43, Sector-35, HSIDC,
Gurgaon-122001, Haryana, India
T +91 124 4874 900
E ups.india@deltaww.com

Indonesia

Wisma Aldiron 1st Floor, Suite 140, Jl. Jend.
Gatot Subroto Kav. 72, Jakarta 12780,
Indonesia
E ups.indonesia@deltaww.com

South Korea

Delta Electronics (Korea), Inc.
1511, Byucksan Digital Valley 6-cha, Gasan-
dong, Geumcheon-gu, Seoul, Korea 153-704
T +82 2 515 5303
E ups.south.korea@deltaww.com

Malaysia

C-05-08, LEVEL 05, BLOCK C, SKYPARK
One City, Jalan USJ 25/1
47650 Subang Jaya
Selangor Darul Ehsan, Malaysia
E ups.malaysia@deltaww.com

Philippines

Unit 1001 Richmond Plaza, San Miguel Ave.,
Ortigas Centre, Pasig City, Philippines
E ups.philippines@deltaww.com

Singapore

Delta Energy Systems (Singapore) Pte Ltd.
4 Kaki Bukit Ave 1, #05-04, Singapore
417939
T +65 6747 5155
E ups.singapore@deltaww.com

Taiwan

Delta Electronics Inc.
39 Section 2, Huandong Road,
Shanhua Township
Tainan County 74144, Taiwan
T +886 6 505 6565
E ups.taiwan@deltaww.com

Thailand

Delta Electronics (Thailand) Public Co., Ltd.
909 Soi 9, Moo 4, E.P.Z., Bangpoo
Industrial Estate, Tambon Prakasa,
Amphur Muang-samutprakarn,
Samutprakarn Province 10280, Thailand
T +662 709-2800
E ups.thailand@deltaww.com

Vietnam

3rd floor, RIC Building, 51 Hoang Viet, Tan Binh,
Ho Chi Minh City Vietnam
E ups.vietnam@deltaww.com



The power behind competitiveness

Delta InfraSuite Cast Resin Busway System

BL Series, 250A-5000A
IP68, UL857

www.deltapowersolutions.com



Delta Group

Leading expert in power management and thermal management solutions

Delta Group is the world's leading provider of power management and thermal management solutions, as well as a major source for components, visual displays, industrial automation, networking products, and renewable energy solutions. Delta Group is focused on three main businesses: power electronics, energy management, and smart green life. Delta Group has sales offices worldwide and manufacturing plants in Taiwan, China, Thailand, Japan, Mexico, India, Brazil and Europe.

As a global leader in power electronics, Delta's mission is, "To provide innovative, clean and energy-efficient solutions for a better tomorrow." Delta is committed to environmental protection and has implemented green, lead-free production and recycling and waste management programs for many years.

More information about Delta Group can be found at <http://www.deltaww.com/>

World no. 1 in Switching Power Supplies, DC Brushless Fans and Telecom Power Systems

163 sales offices and **39** manufacturing facilities worldwide

5%-6% of annual sales revenues invested in R&D with over **7,000** engineers in **64** R&D centers worldwide

Awarded **7,100+** patents and received **47** internationally recognized design awards including iF, Reddot, and the Taiwan Excellence awards.

No. 1 Supplier of Merchant Power Supplies

According to the IHS report, Delta Electronics remained the largest supplier of merchant power supplies with an estimated market share of 15.5% in 2016 of a global market value that was estimated to be \$21,869 M.

The Total Merchant Power Supply Market 2016 \$M Revenue

Ranking	Company Name	Market Share
1	Delta Electronics	15.5%
2	Axxxxxn	7.5%
3	Lxxxxx Technology	4.5 %

Source : AC-DC & DC-DC Merchant Power Supplies, IHS, 2017

Global Footprint

	Asia-Pacific (China)	Americas	EMEA	Total
Sales Offices	104 (61)	20	39	163
Plant Sites	32 (19)	4	3	39
R&D Centers	43 (23)	7	12	64

- Sales Offices
- Plant Sites
- R&D Centers



Awards

Delta Electronics outperformed 37 leading global companies in the Electronic Equipment, Instrument, and Component sector of the 2017 Dow Jones Sustainability Indexes (DJSI), and was selected for the DJSI World Index for the seventh consecutive year.



2007 - 2008
Forbes Asia's
Fabulous 50



2009
Frost & Sullivan Green
Excellence Award for
Corporate Leadership



2014
CPLI Climate Performance
Leadership Index, CPLI

MEMBER OF
**Dow Jones
Sustainability Indexes**
In Collaboration with RobecoSAM

2011 - 2015
Dow Jones
Sustainability Indexes

More information about Delta Group can be found at <http://www.deltaww.com/>





Table of contents

• Product Portfolio	1
• System Architecture	3
• Features & Advantages	4
• Safety	5
• Busway	6
• Joint	8
• Plug-in Unit	9
• Applications	10
• Technical Specifications	11 - 28

Delta Cast Resin Busway System

A Flexible, Safe, and Reliable Low Voltage Power Distribution Solution

The Busway BL Series from Delta are made from epoxy using vacuum casting. Superior to traditional cables or sandwich type busway solutions, Delta's Busways significantly improve the protection ratings, safety and reliability of products, are ideal for use in harsh environmental conditions, and can be extensively applied to a range of industries. Thanks to the outstanding electrical and mechanical properties of resin, these busways have reduced dimensions, a simplified structure, extended service life, and improved reusability. More importantly, Delta's Busways provide excellent energy-savings to help our customers enjoy substantial savings on their electricity bills.

Customer Value

- Flexible modular design allows easy disassembly, reconstruction, and expansion as well as high re-usability
- Excellent safety, as well as waterproof, dustproof, fireproof, shock-proof, and corrosion-proof
- Certified according to market-specific or customer-specific needs, such as by the IEC, CNS, GB, and others
- Highly compact



Delta's Busways vs. Traditional Cable

Delta's Busways excel over traditional cables in terms of safety, electrical properties, reliability, and scalability, making them the best choice for companies looking at optimum TCO.

	Cast Resin Busway system	Normal Cable
System flexibility	Easily detaching joints, replaceable, re-usable and highly adaptable to system design changes	Need re-wiring in case of system changes
Installation and configuration	Quick installation and configuration	Wiring over premises, costly and time-consuming
Space use efficiency	Only 30% of traditional cable wiring, effective in saving installation space	Ducts in addition to wiring, bulky
Appearance	Easy to identify and manage at a glance	Messy power wiring, complicated looks
Fire resistance	High, IEC60331	None
IP Rating	IP68	Not specified in the general technical data
Resistance to chemical and corrosion	Excellent	Poor
Instantaneous short-circuit strength	High	Low
Overload capacity (+25% 2hr)	High	Low in heat resistance (up to about 60°C), thus being dangerous when overloaded, leading to accelerated insulating materials aging and reduced service life
Insulation rating	High, resin insulation Class F (155°C).	Low

System Architecture

- 1 Feeder section
- 2 Flatwise elbow
- 3 Edgewise elbow
- 4 Flange end
- 5 Flange end/FST
- 6 Plug-in section (bolt-on type)
- 7 Plug-in slot (bolt-on type)
- 8 Plug-in unit (bolt-on type)
- 9 Plug-in section (plug-in type)
- 10 Plug-in slot (plug-in type)
- 11 Plug-in unit
- 12 Cable box/End feed box
- 13 Joint
- 14 Spring hanger

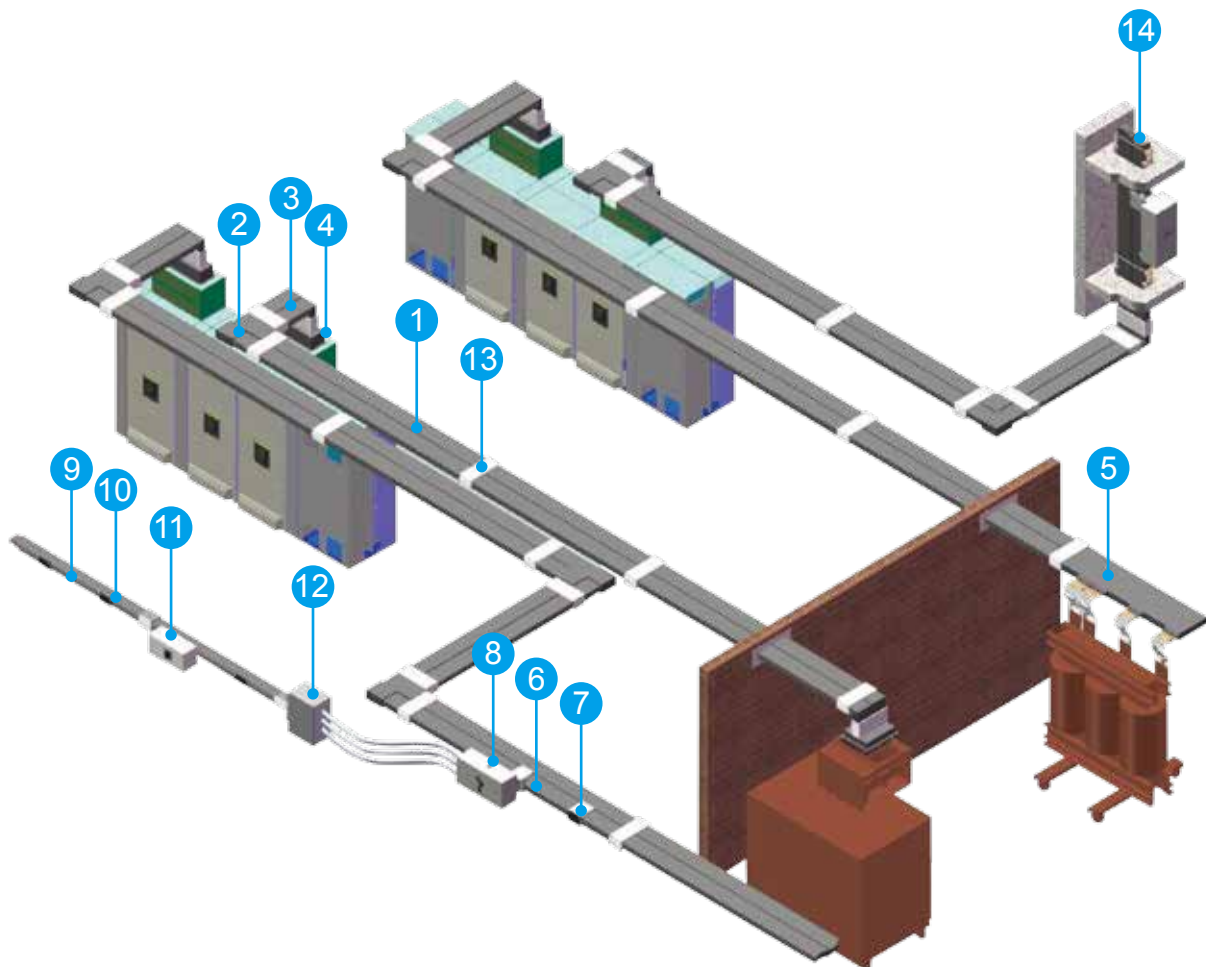

Features and Advantages

Safe, reliable, innovative, energy-saving

Key Specifications and Functions

- Copper 400A ~ 5000A,
Aluminum 250A ~ 4000A
- Rated voltage up to 1000V.
- Operating ambient temperature -20°C ~50°C, daily average up to 35°C
Altitude up to 2,000 meters.
- Model 3P3W or 3P4W, 50%G or 100%G.
- IP68 at busway feeder section, IP54 at plug-in section
- Modular design, easy disassembling and reassembling, and highly expandable
- Integrated cast resin block, with detachable bridge-type joints .
- Easy installation, effective foolproof design to prevent installation errors
- Design and Standards IEC60439-2, IEC61439, IEC60529, IEC60331, IEC60332
GB7251.1,GB7251.2, UL857,

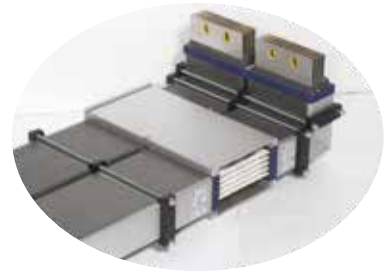

Innovative Energy-saving Materials

Normal busways have high power-consuming resistors in conductors, leading to expensive electricity bills. Delta's Busway uses state-of-the-art technology to not only cut electricity costs, but also effectively reduce electromagnetic interference, preventing damage to precision equipment.

- **CoAlly Technology:** Conductors are set to the optimum low-resistance state to reduce energy consumption as well as carbon footprints, while contributing to environmental protection and low power costs.
- **SiShield Technology:** With a low-impedance electrolytic copper plate, the conductor has optimum low resistance, effectively reducing loss and voltage drops. In addition, the internally coated composite significantly mitigates electromagnetic interference to protect precision equipment.



Flexible and Cost-saving

- Delta's Cast Resin Busway system is only 60% of the size of traditional sandwich busways, and 30% of the size of traditional electrical cable wiring.
- The busway joint is constructed as moving connecting modules, easy to assemble, disassemble, expand, and reuse when changing layout.
- The plug-in unit works with MCCB from major manufacturers allowing live line operations at anytime to change loads without cutting off power and saving both time and money.
- Maintenance-free throughout its service life, reducing OPEX.

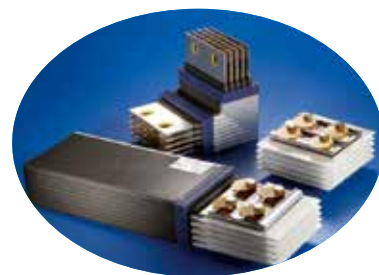

Safety

Waterproof, Dustproof

Delta's Cast Resin Busway system implements an integrated, formed design, with the conductors fully sealed in an epoxy composite during casting. Thanks to the outstanding binding and sealing properties of epoxy materials, the cast busways are highly waterproof.

Ideal for demanding weather conditions and rugged operating environments, such as:

- Outdoors, pipe, AC plant rooms, and other spaces where condensate tends to form
- Locations with many fire-fighting hoses, water piping and chemical ducts
- Resistant to salt corrosion, high humidity environment



Fire resistance: IEC60332
IEC60331 750°C 3hrs
CNS12514 840°C 30mins

Delta's busways are certified as fire resistance with industrial IEC standard, and conform to the latest fire control regulations. In case of fire, the busways can ensure a continuous emergency power supply to prevent injuries and/or facility damage, and would play an important role in electrical safety.



Shock-proof: 0.8g

Shock-proof rating $>0.4g$ = Magnitude 7.

Shock-proof tests have been performed with simulated real-life building construction, including steel structures, horizontal busways, vertical busways, busway elbows, plug-in units, hangers, spring hangers and more, to ensure all components are resistant to shock.



Explosion-proof: Exm II CNS3376/IEC60079

Ideal for use in a demanding environments with a risk of explosion, such as compressed natural gas filling stations, oil refineries, offshore platforms, wind farms, tunnels, mines, and others

Impact-proof: IK10

Busways

Conductor Materials

Copper and aluminum conductors are available. Copper conductors have electric conductivity of higher than 99.9%, while aluminum conductors have electric conductivity of higher than 56%. For optimum electric conductivity and contact reliability, both the copper and aluminum conductors are plated entirely with tin.

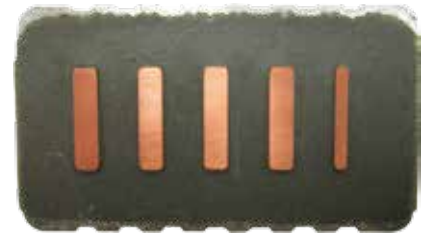

Resin Materials

For the best possible electrical, mechanical, waterproof, fireproof and self-extinguishing properties, the resin materials and their whole set of formulas are sourced from the most experienced and renowned manufacturers. The insulation rating is Class F, with a temperature limit up to 155°C. The resin is made with a high proportion of inorganic materials, such as natural sands transformed and cured into ceramic materials, thus possessing excellent insulating capabilities, high mechanical strength and outstanding fireproof properties.



Busway Structure

Delta's Cast Resin Busways feature an integrated, formed design, with the conductors fully sealed in an epoxy composite during casting, with highlights that include:

- Waterproof
- Epoxy made with a high proportion of inorganic materials such as natural sand that possess excellent insulating capability, high mechanical strength and excellent fireproof properties
- Plug-in unit works with MCCB from major manufacturers allowing live line operations anytime to change loads, without cutting off power to save both time and money
- Maintenance-free throughout its service life, saving on operating costs

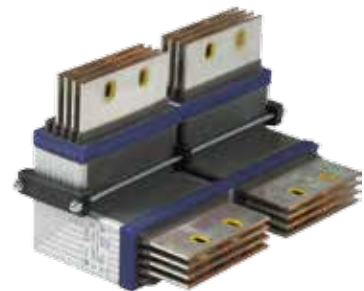

Busway IP rating

Conforming to IEC60529, CNS14165 standards, higher rating is available under demand.

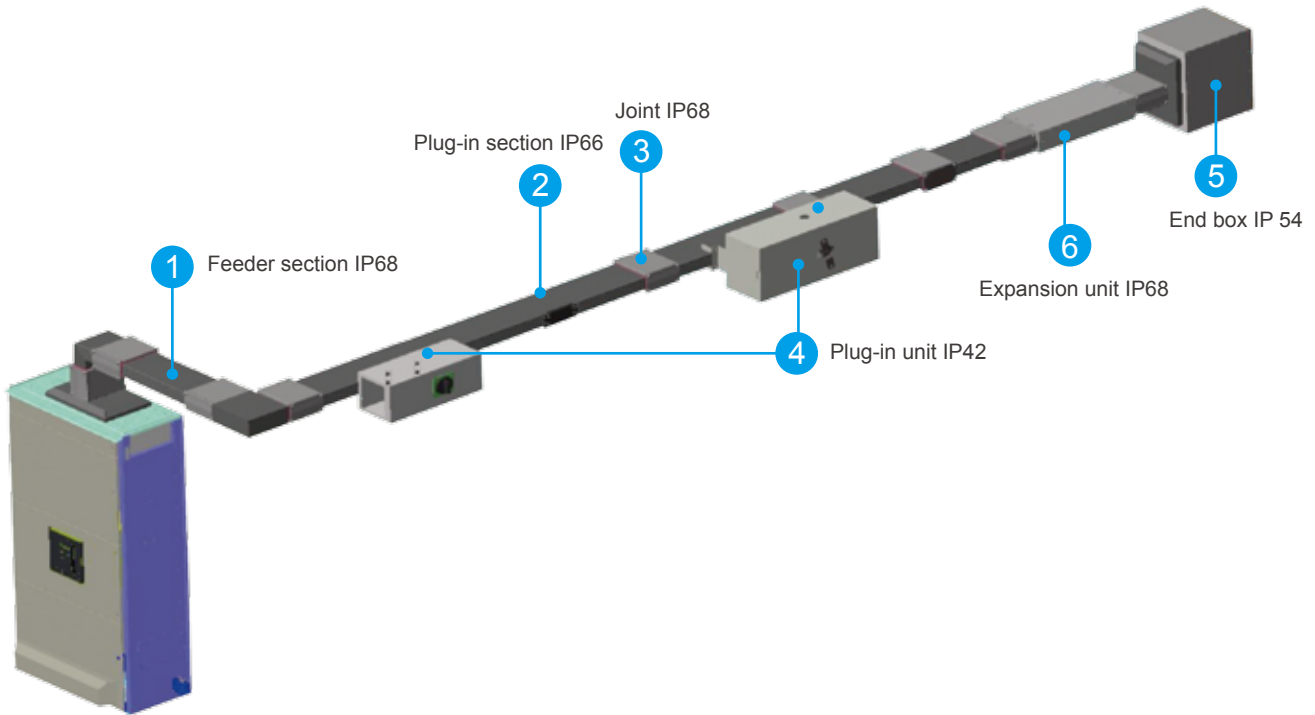

Ingress Protection rating

IP X X

Code Digit	1 st Code Digit	2 nd Code Digit
	Protected against contact with dangerous parts and foreign objects	Protected against water
0	No particular protection	No particular protection
1	I. Protecting back of the hand from getting in contact with dangerous parts II. Protecting against solid objects greater than 50mm in diameter	Protecting against vertically falling water drops
2	I. Protected against finger contact with dangerous parts II. Protecting against solid objects greater than 12.5mm in diameter	Protecting against vertically falling water drops when enclosure is tilted up to 15°
3	I. Protecting against test stick greater than 2.5mm in diameter from getting in contact with dangerous parts II. Preventing contact with foreign objects greater than 2.5mm in diameter	Protecting against water sprayed at an angle of up to 60° degrees on either side of the enclosure
4	I. Protecting against test stick greater than 1.0mm in diameter from getting in contact with dangerous parts II. Protecting against solid objects greater than 1.0mm in diameter	Protecting against water splashed against enclosure from any direction
5	Dust protected, dust not allowed to interfere with safety of the product	Protecting against water splashed against enclosure from any direction for continuous 3 minutes
6	Dustproof, no ingress of dust	Protecting against water injected against enclosure from any direction for continuous 3 minutes
7		Protecting against water when enclosure is immersed in water with the lowest point of the enclosure 1 m below the water surface , for 30 minutes
8		Protecting against water when enclosure is immersed in water with depth and duration expected to be greater than requirements for Class 7

Joint



- Connection between busways is achieved by linking conductors of two busways with a movable joint. With the easily detachable joint design, replacing busways when changing power system design or adding loops, can be done in a short time, minimizing downtime.



- With the double-bolt design, stress distribution over the copper plate contact surfaces at the joint is more extensive and uniform, ensuring more reliable binding for the two busways. This promises reliability even after long-term stress fluctuation due to thermal expansion.

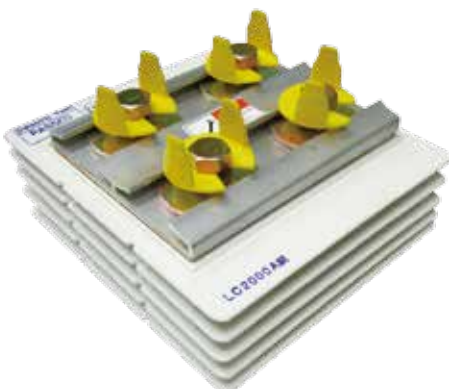

- The busway uses a 4-piece movable packing at the joint. After the screws at the joint are screwed to the end with a required torque, and the indication tag falls, the cap is forced onto the busways following the sealing and screwing process. The solid silicone packing wrapping the busway joint and the cap will seal any seam to ensure IP68 waterproof reliability at the joint.
- The joint is designed with foolproof functions that only allow fixed-torque screws to be set when busways are correctly positioned. Not until the fixed-torque screws are screwed to the end and have the head falling, can the sealing plate be installed. This ensures every installation step of the busway joint is done properly.

Plug-in unit

- With this plug-in unit design, when users want to add equipment or adjust power load, what they need to do is to get parts meeting the specifications of the desired plug-in unit specifications and mount the plug-in unit to the proper and closest busway slot to guide out power, without cutting off the busway. This allows for quick and easy installation, and in turn great flexibility and convenience.
- Plug-in unit is provided in two versions, both allowing live line plug/unplug operations:
 - Plug-in type capacity: Up to 630A, with conductive clip design, suitable for light load systems.
 - Bolt-on type capacity: Up to 2000A, with a bolt bridge design, suitable for heavy load systems.
Bolt packing ensures great reliability.
- The plug-in section busway has a standard length of 4.2m, with up to 5 reserved input ports. The number and location of input ports may be customized to customers' needs, thereby saving costs and preventing unnecessary waste.
- The plug-in units are able to be customized with MCCB from any leading manufacturer and is highly adaptable to customers' practical needs.
- The plug-in unit may be equipped with a monitoring module, allowing power information to be read on board or otherwise displayed, or transmitted to the monitoring system through RS485.



Plug-in unit with monitoring module



Conductive clip design
(Plug-in Type)



Bolt bridge design
(Bolt-on Type)

Applications

With the rapid growth of global IT industry, factories are built to increasingly large scales. This adds to the demand for quality power supply, safe power transfer and efficient systems, as well as greater expandability. As busway development has reached higher levels of reliability, safety and flexibility due to fast delivery and flexible engineering changes, busways are now used extensively in a variety of industries.

In addition to power transmission/distribution, Delta's Busways also feature high protection ratings and are ideal for harsh environmental conditions and mission critical applications required high reliability and safety.

	Emergency, outdoor applications	Petro-chemistry, marine, oil & gas	Critical equipment, datacenters	Electronics, semiconductor, wafer fabrication	Water treatment	Wind farms
Waterproof, dustproof IP68	●	●	●	●	●	●
Fireproof and burning-proof	●	●			●	●
Explosion-proof	●	●	●	●	●	●
Resistance to chemical corrosion	●	●	●	●	●	●
Shock-proof		●		●	●	●



Technical Specifications

Busway Ratings	250A	400A	600A	800A	1000A	1250A	1500A	1600A	2000A	2500A	3200A	4000A	5000A
Models													
Copper		BLC04	BLC06	BLC08	BLC10		BLC15	BLC16	BLC20	BLC25	BLC32	BLC40	BLC50
Aluminum	BLA02	BLA04	BLA06	BLA08	BLA10	BLA12	BLA15	BLA16	BLA250	BLA25	BLA32	BLA40	
Rated voltage	V	1000	1000	1000	1000	1000	1000	1000	1000	1000	1000	1000	1000
Rated current	A	250	400	600	800	1000	1250	1500	1600	2000	2500	3200	4000
Frequency	Hz	50/60	50/60	50/60	50/60	50/60	50/60	50/60	50/60	50/60	50/60	50/60	50/60
Conductor	Copper purity: 99.9% conductivity: 99.9%IACS Aluminum purity: 98.0% conductivity: 56.0%IACS												
Conductor plating	Tin plating												
Insulation material	Epoxy Cast resin												
Insulation class	F class 155°C												
Fire resistance	IEC60331 750°C 3hrs; IEC60332 CNS12514 840°C 30mins(Special made-C)												
Ingress protection rating	IP68												
Earthquake test	0.8g [magnitude >7]												
Explosive-symbol	ExmII												
Mechanical Impact	IK10												
Color	RAL7043												
Plug-in unit													
Type	Plug-in type/Bolt-on type												
Pole	1P/2P/3P/4P												
Max.rating	Plug-in type 630A Bolt-on type 2000A												
MCCB brands	Mitsubishi, Fuji, GE, Schneider (MG), or Customer specified												
Protection rating	IP42/IP54 (Option) IP42												
Panel coating	Powder coated paint												
Coating thickness	Indoor 40µm/outdoor 50µm												
Color	RAL7047/RAL7043												
General													
Standards	IEC61439,IEC60331,IEC60332 GB7251.1,GB7251.2,UL857												
Ambient temperature	-20°C/+50°C												
Altitude	≤ 2,000m												

Temperature rise

Temperature rise graph (Copper)

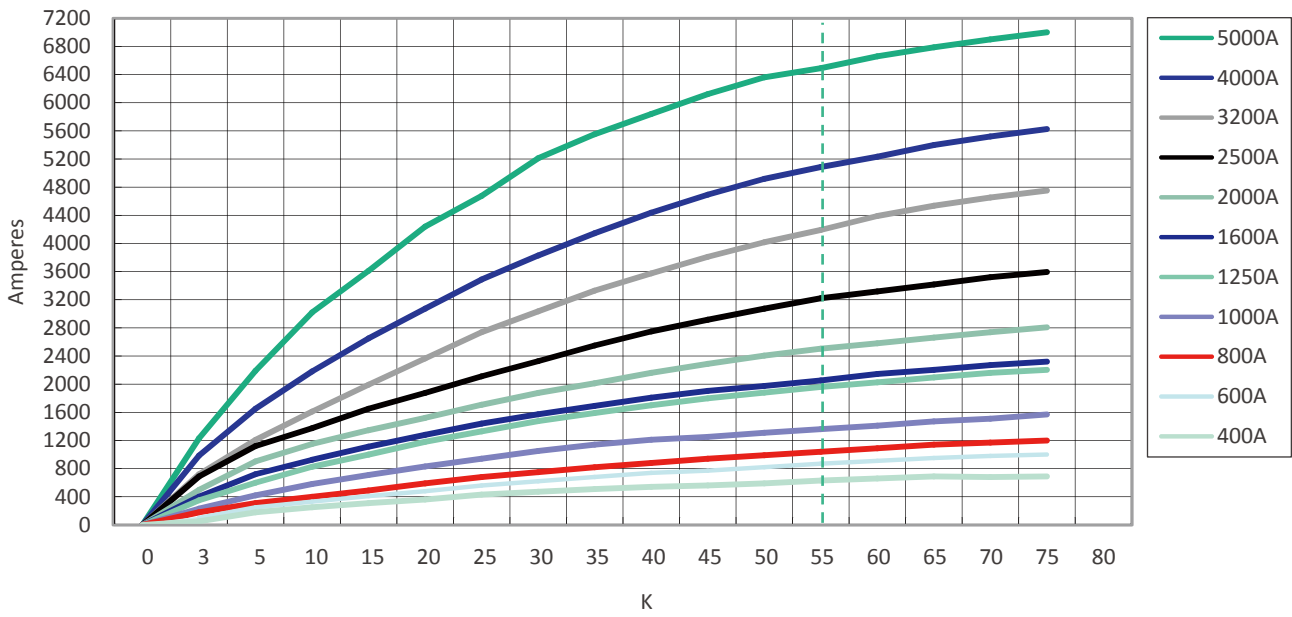

Temperature rise graph (Aluminum)

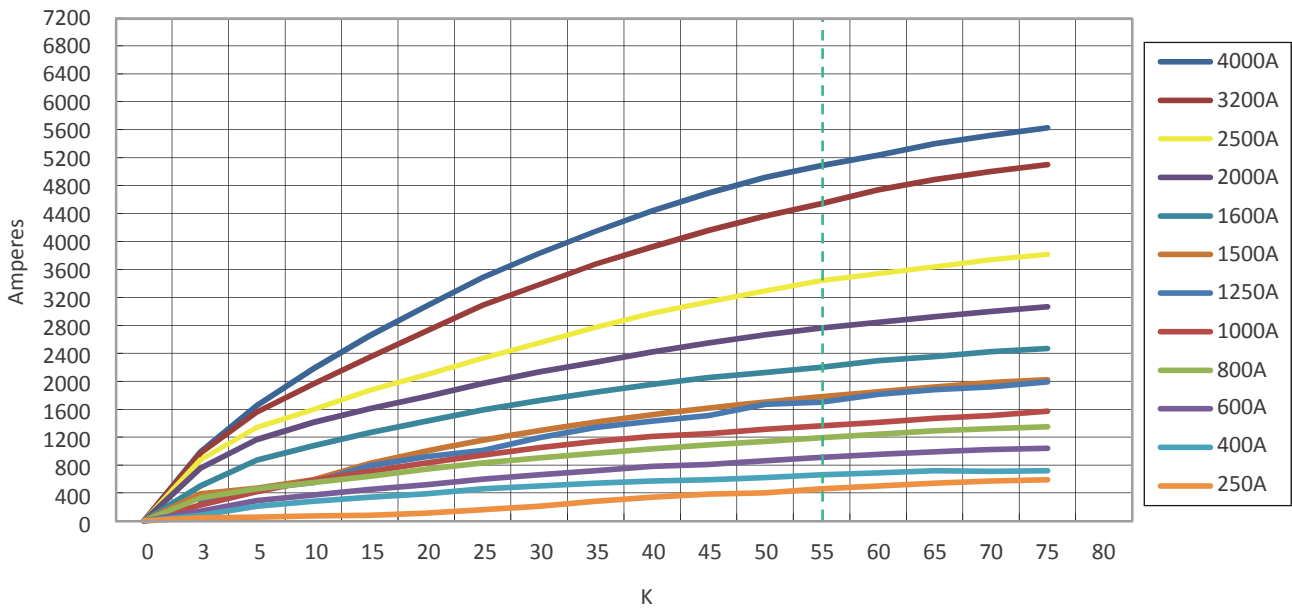

Short-circuit strength

Copper

Rating [A]	RMS Symmetrical (kA)		
	6 cycles	1 sec	3 sec
400	140	65	38
600	140	65	38
800	140	65	38
1000	140	65	38
1250	175	80	46
1600	175	80	46
2000	220	100	58
2500	280	130	75
3200	410	175	101
4000	410	200	115
5000	410	200	115

Aluminum

Rating [A]	RMS Symmetrical (kA)		
	6 cycles	1 sec	3 sec
250	105	50	29
400	105	50	29
600	105	50	29
800	140	65	38
1000	140	65	38
1250	140	65	38
1500	140	65	38
1600	175	80	46
2000	175	80	46
2500	220	100	58
3200	280	130	75
4000	410	175	101

Busway elements

LH-type elbow
Flatwise elbow

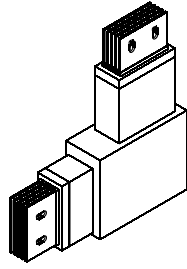

LV-type elbow
Edgewise elbow

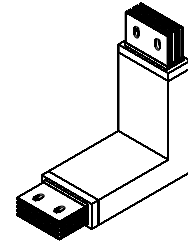

NH-type elbow
Flatwise offset

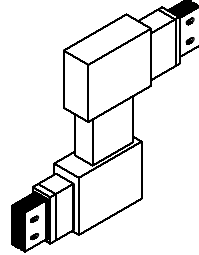

NV-type elbow
Edgewise offset

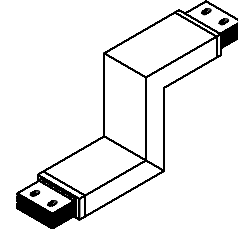

TH-type elbow
Flatwise Tee

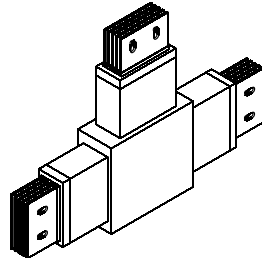

TV-type elbow
Edgewise Tee

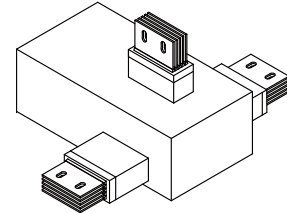

CH-type elbow
Flat to edge elbow

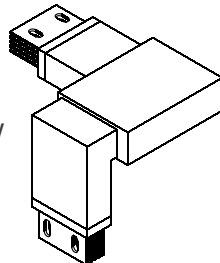

CV-type elbow
Edge to flat elbow

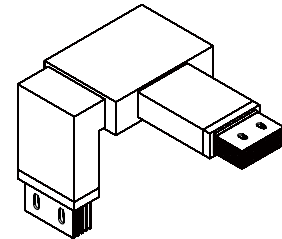

FS type flange end
Flange end

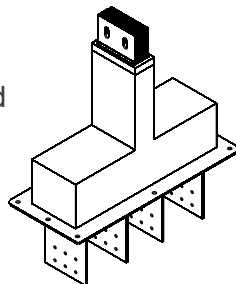

FV-type flange end
Flange end/
edgewise elbow

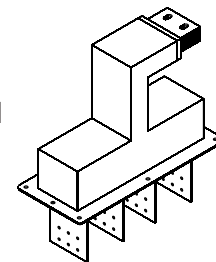

FH-type flange end
Flange end/
flatwise elbow

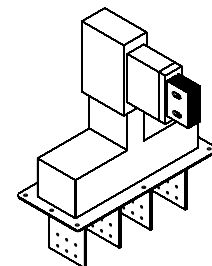

Busway elements

End tap box

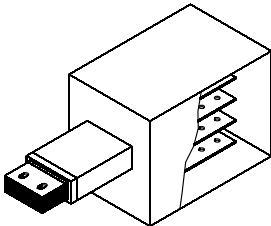

Center tap box

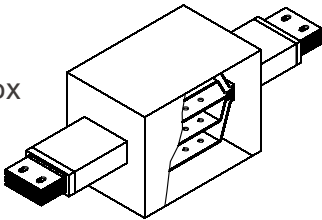

Plug-in unit

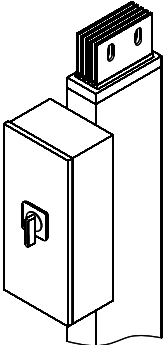

Plug-in unit / Power meter box

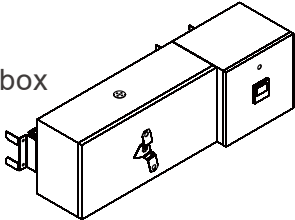

Expansion fitting

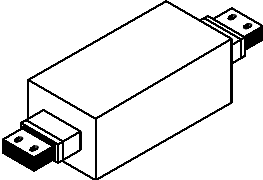

Unfused reducer

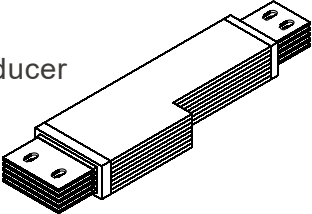

End cover

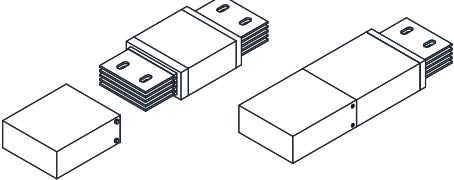

Feeder end

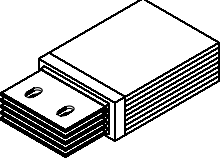

Ceiling trapeze

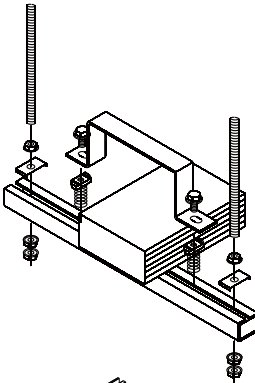

Wall/Floor flange

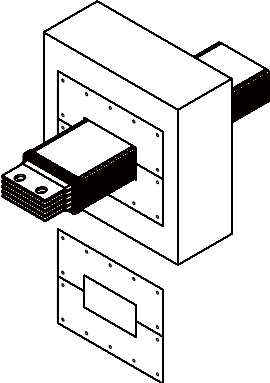

Spring hanger

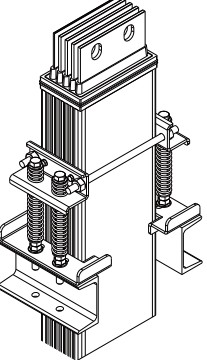

Properties

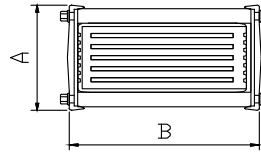
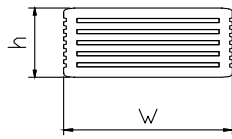

► Figure 1

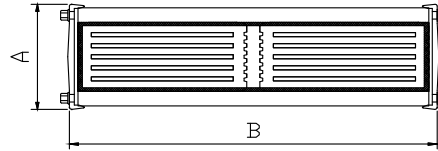
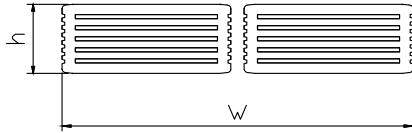

► Figure 2

Copper

Busway Ratings		400A	600A	800A	1000A	1250A	1600A	2000A	2500A	3200A	4000A	5000A
Models		BLC04	BLC06	BLC08	BLC10	BLC12	BLC16	BLC20	BLC25	BLC32	BLC40	BLC50
Rated voltage	V	1000	1000	1000	1000	1000	1000	1000	1000	1000	1000	1000
Rated current	A	400	600	800	1000	1250	1600	2000	2500	3200	4000	5000
Frequency	Hz	50/60	50/60	50/60	50/60	50/60	50/60	50/60	50/60	50/60	50/60	50/60
Impedance values												
For busway operating at 50Hz frequency and 85°C temperature												
Resistance R_{20}	$\mu\Omega/m$	106.3	68.7	50.2	34.7	23.0	17.9	15.1	11.6	9.0	7.6	6.1
Resistance R_{85}	$\mu\Omega/m$	133.5	86.2	63.0	43.5	28.9	22.5	18.9	14.5	11.3	9.5	7.7
Reactance X_{50}	$\mu\Omega/m$	112.3	79.9	57.3	42.3	28.0	22.1	17.7	13.4	10.0	8.8	6.3
Impedance Z_{50}	$\mu\Omega/m$	174.5	117.5	85.2	60.7	40.2	31.5	25.9	19.7	15.1	12.9	9.9
For busway operating at 60Hz frequency and 85°C temperature												
Resistance R_{20}	$\mu\Omega/m$	106.3	68.7	50.2	34.7	23.0	17.9	15.1	11.6	9.0	7.6	6.1
Resistance R_{85}	$\mu\Omega/m$	133.5	86.2	63.0	43.5	28.9	22.5	18.9	14.5	11.3	9.5	7.7
Reactance X_{60}	$\mu\Omega/m$	134.8	95.9	68.8	50.8	33.6	26.5	21.2	16.1	12.0	10.6	7.6
Impedance Z_{60}	$\mu\Omega/m$	189.7	128.9	93.3	66.9	44.3	34.8	28.4	21.7	16.5	14.2	10.8
Conductor cross-section												
L1,L2,L3	mm ²	145	232	307.4	464	696	928	1160	1392	1856	2320	2784
N(100%)	mm ²	145	232	307.4	464	696	928	1160	1392	1856	2320	2784
G(Internal)	mm ²	72.5	116	153.7	232	348	464	580	696	928	1160	1392
Busway Dimension												
h x w	mm	100x55	100x70	100x83	100x110	100x150	100x190	100x230	100x270	100x395	100x475	100x555
Joint A x B	mm	152x93	152x93	152x106	152x133	152x173	152x213	152x253	152x293	152x418	152x498	152x578
Figure		1	1	1	1	1	1	1	1	2	2	2

Voltage drop $\Delta U = \sqrt{3} \times I (R_{85} \cos\phi + X_{50/60} \sin\phi)$ (V/m)

I : loading current $\cos\phi$: power factor $\sin\phi = (1 - \cos^2\phi)^{1/2}$

Properties

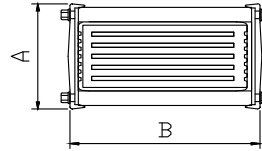
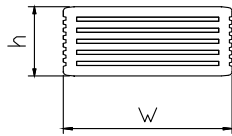

→ Figure 1

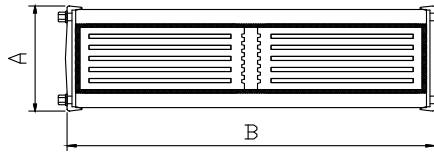
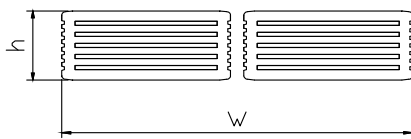

→ Figure 2

Aluminum

Busway Ratings		250A	400A	600A	800A	1000A	1250A	1500A	1600A	2000A	2500A	3200A	4000A
Models		BLA02	BLA04	BLA06	BLA08	BLA10	BLA12	BLA15	BLA16	BLA20	BLA25	BLA32	BLA40
Rated voltage	V	1000	1000	1000	1000	1000	1000	1000	1000	1000	1000	1000	1000
Rated current	A	250	400	600	800	1000	1250	1500	1600	2000	2500	3200	4000
Frequency	Hz	50/60	50/60	50/60	50/60	50/60	50/60	50/60	50/60	50/60	50/60	50/60	50/60
Impedance values													
For busway operating at 50Hz frequency and 85°C temperature													
Resistance R_{20}	$\mu\Omega/m$	110.2	84.8	55.1	47.0	39.3	29.8	24.8	21.8	15.7	13.6	10.9	9.3
Resistance R_{85}	$\mu\Omega/m$	138.2	106.3	69.1	58.9	49.3	37.4	31.1	27.4	19.7	17.1	13.7	11.6
Reactance X_{50}	$\mu\Omega/m$	128.0	76.5	56.9	49.8	38.6	28.9	22.3	17.4	12.9	10.0	8.3	5.1
Impedance Z_{50}	$\mu\Omega/m$	188.4	131.0	89.5	77.1	62.6	47.3	38.3	32.5	23.5	19.8	16.0	13.0
For busway operating at 60Hz frequency and 85°C temperature													
Resistance R_{20}	$\mu\Omega/m$	110.2	84.8	55.1	47.0	39.3	29.8	24.8	21.8	15.7	13.6	10.9	9.3
Resistance R_{85}	$\mu\Omega/m$	138.2	106.3	69.1	58.9	49.3	37.4	31.1	27.4	19.7	17.1	13.7	11.6
Reactance X_{60}	$\mu\Omega/m$	153.6	91.8	68.3	59.8	46.3	34.7	26.8	20.9	15.5	12.0	9.9	7.0
Impedance Z_{60}	$\mu\Omega/m$	206.6	140.5	97.2	83.9	67.6	51.0	41.1	34.5	25.1	20.9	16.9	13.5
Conductor cross-section													
L1,L2,L3	mm ²	232	307.4	464	580	696	928	1160	1392	1392	2320	2784	2784
N(100%)	mm ²	232	307.4	464	580	696	928	1160	1392	1392	2320	2784	2784
G(Internal)	mm ²	116	153.7	232	290	348	464	580	696	696	1160	1392	1392
Busway Dimension													
h x w	mm	100x70	100x83	100x110	100x130	100x150	100x190	100x230	100x270	100x270	100x475	100x555	100x555
Joint A x B	mm	152x93	152x106	152x133	152x153	152x173	152x213	152x253	152x293	152x293	152x498	152x578	152x578
Figure		1	1	1	1	1	1	1	1	1	2	2	2

Voltage drop $\Delta U = \sqrt{3} \times I \times (R_{85} \cos\phi + X_{50/60} \sin\phi)$ (V/m)

I : loading current $\cos\phi$: power factor $\sin\phi = (1 - \cos\phi^2)^{1/2}$

Dimensions and Weight

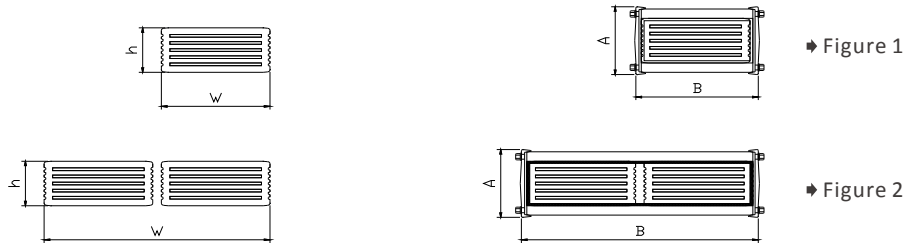

Copper

Busway Ratings		400A	600A	800A	1000A	1250A	1600A	2000A	2500A	3200A	4000A	5000A
Models		BLC04	BLC06	BLC08	BLC10	BLC12	BLC16	BLC20	BLC25	BLC32	BLC40	BLC50
h x w	mm	100x55	100x70	100x83	100x110	100x150	100x190	100x230	100x270	100x395	100x475	100x555
Joint AxB	mm	152x93	152x93	152x106	152x133	152x173	152x213	152x253	152x293	152x418	152x498	152x578
Weight 3P3W 50% G	Kg/m	13.9	18.9	23.3	32.4	45.8	59.3	72.7	86.1	118.6	145.4	172.2
Weight 3P3W 100% G	Kg/m	14.5	19.7	24.5	34.1	48.3	62.6	76.8	91.1	125.2	153.6	182.2
Weight 3P4W 50% G	Kg/m	15.0	20.6	25.5	35.7	50.8	65.9	81.0	96.0	131.8	162.0	192.0
Weight 3P4W 100% G	Kg/m	15.5	21.4	26.6	37.4	53.3	69.2	85.1	101.0	138.4	170.2	202.0
Figure		1	1	1	1	1	1	1	1	2	2	2

Aluminum

Busway Ratings		250A	400A	600A	800A	1000A	1250A	1500A	1600A	2000A	2500A	3200A	4000A
Models		BLA02	BLC04	BLC06	BLC08	BLC10	BLA12	BLA15	BLA16	BLA20	BLA25	BLA32	BLA40
h x w	mm	100x70	100x83	100x110	100x130	100x150	100x190	100x230	100x270	100x270	100x475	100x555	100x555
Joint AxB	mm	152x93	152x106	152x133	152x153	152x173	152x213	152x253	152x293	152x293	152x498	152x578	152x578
Weight 3P3W 50% G	Kg/m	14.0	16.6	22.2	26.4	30.6	39.0	47.3	55.6	55.6	94.6	111.2	111.2
Weight 3P3W 100% G	Kg/m	14.1	16.7	22.5	26.7	30.9	39.4	47.8	56.2	56.2	95.6	112.4	112.4
Weight 3P4W 50% G	Kg/m	14.2	16.9	22.6	26.9	31.2	39.8	48.3	56.8	56.8	96.6	113.6	113.6
Weight 3P4W 100% G	Kg/m	14.3	17.0	22.9	27.2	31.5	40.2	48.8	57.4	57.4	97.6	114.8	114.8
Figure		1	1	1	1	1	1	1	1	1	2	2	2

Flange end

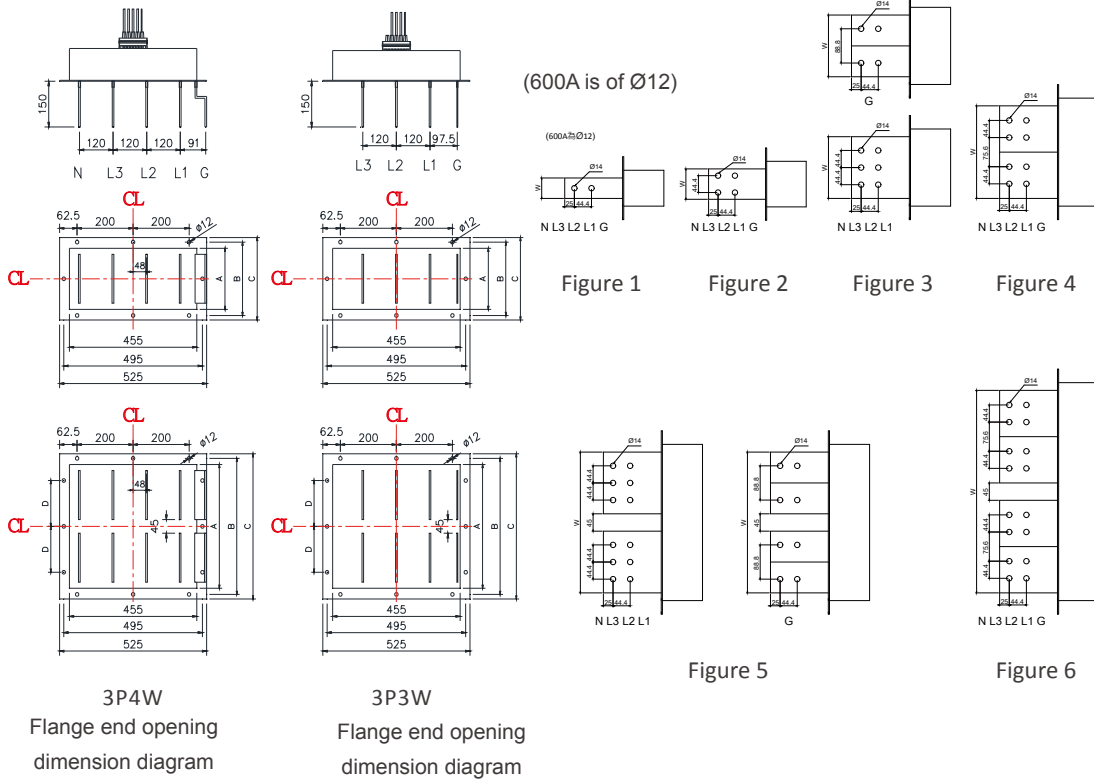

Copper

Busway Ratings		400A	600A	800A	1000A	1250A	1600A	2000A	2500A	3200A	4000A	5000A
A	mm	65	80	93	120	160	200	240	280	405	485	565
B	mm	105	120	133	160	200	240	280	320	445	525	605
C	mm	135	150	163	190	230	270	310	350	475	555	635
D	mm									150	190	230
W	mm	25	40	53	80	120	160	200	240	365	445	525
Figure		1	1	1	2	2	3	3	4	5	5	6
Weight	Kg	10	14	16	22	30	39	46	52	71	87	100

※ For openings of busways with outdoor-type flange end on top, additional technical diagrams are required for compiling the opening dimensions

Flange end

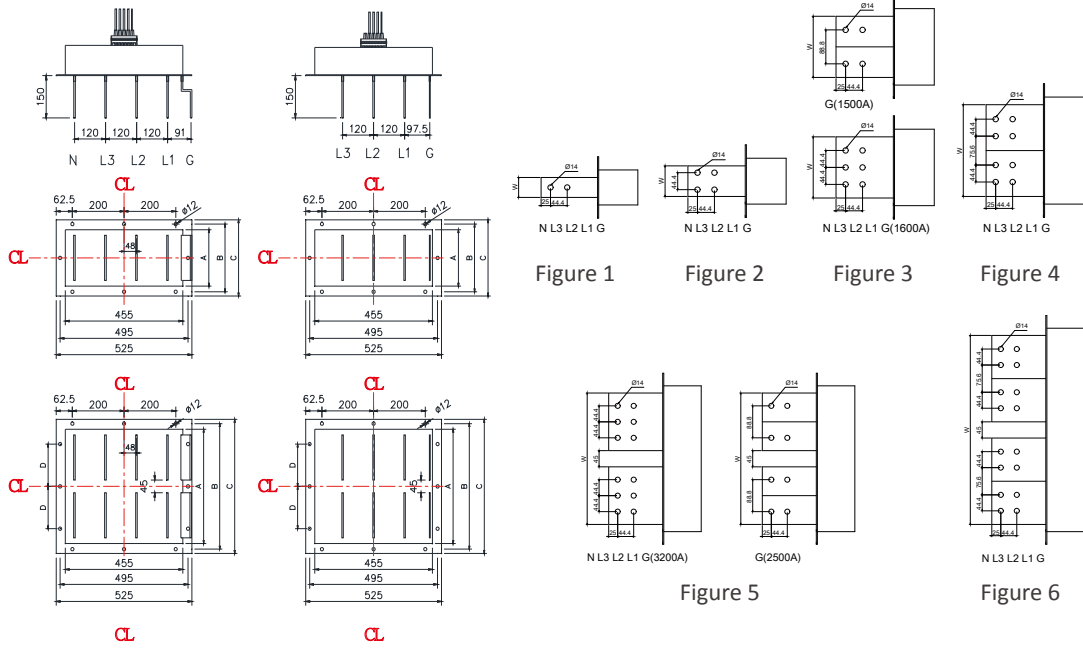

Aluminum

Busway Ratings		250A	400A	600A	800A	1000A	1250A	1500A	1600A	2000A	2500A	3200A	4000A
A	mm	80	93	120	140	160	200	240	280	280	485	565	565
B	mm	120	133	160	180	200	240	280	320	320	525	605	605
C	mm	150	163	190	210	230	270	310	350	350	555	635	635
D	mm										190	230	230
W	mm	40	53	80	100	120	160	200	240	240	445	525	525
Figure		1	1	2	2	2	3	3	4	4	5	6	6
Weight	Kg	10	12	15	16	20	25	31	36	36	60	70	70

※ For openings of busways with outdoor-type flange end on top, additional technical diagrams are required for compiling the opening dimensions

Plug-in Type

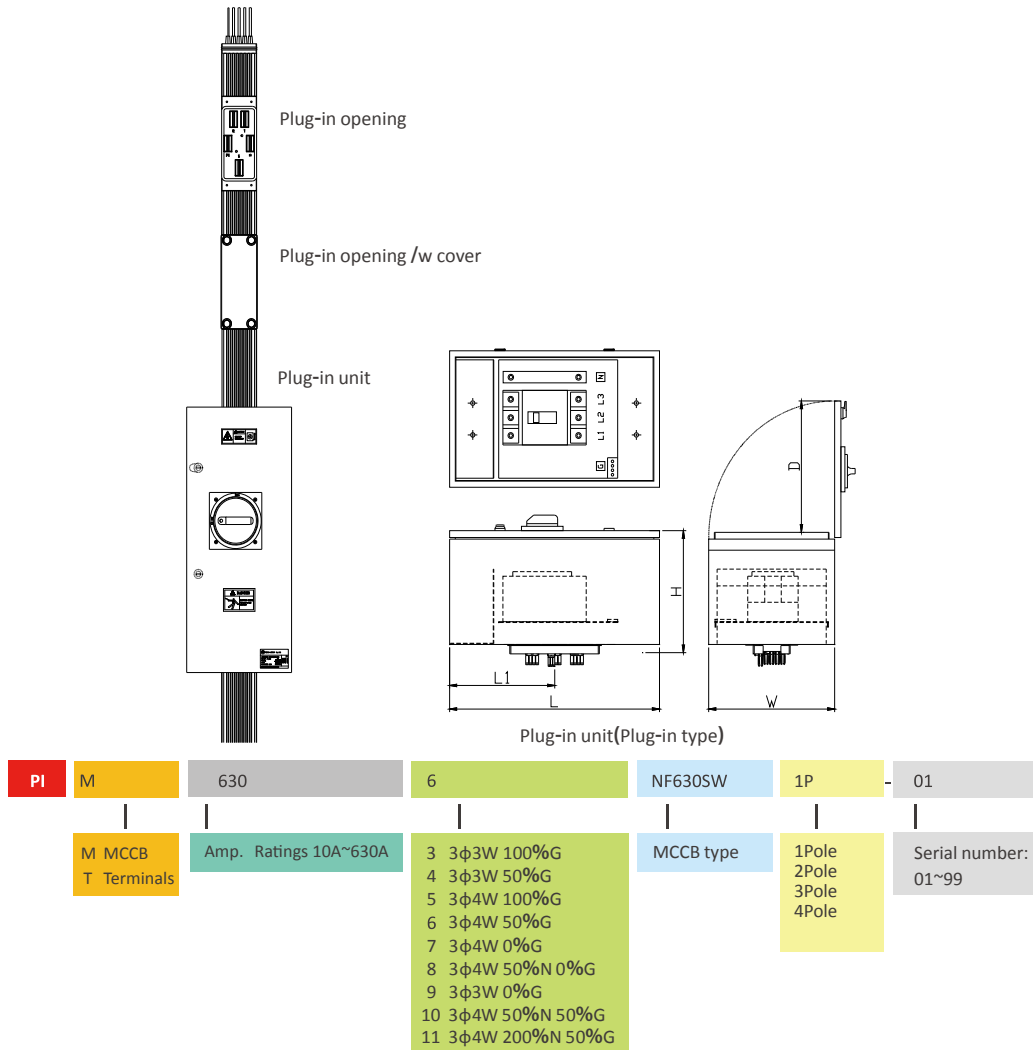

Dimensions

Plug-in Amp. Ratings		30A	63A	100A	225A	250A	400A	630A
L	mm	500	500	500	500	500	700	850
L1	mm	250	250	250	250	250	350	350
W	mm	300	300	300	300	300	300	430
H	mm	275	275	275	275	275	305	335
D	mm	280	280	280	280	280	280	410
IP Rating		IP42	IP42	IP42	IP42	IP42	IP42	IP42
Weight	Kg	15	15	17	21	22	25	53

Note: A standard plug-in unit is rated IP42. For customers needing higher protection rating, IP54 is available on demand

Single side openings may have up to 5 input/output ports, while double sided openings as customized products may have up to 10 input/output ports

Bolt-on Type

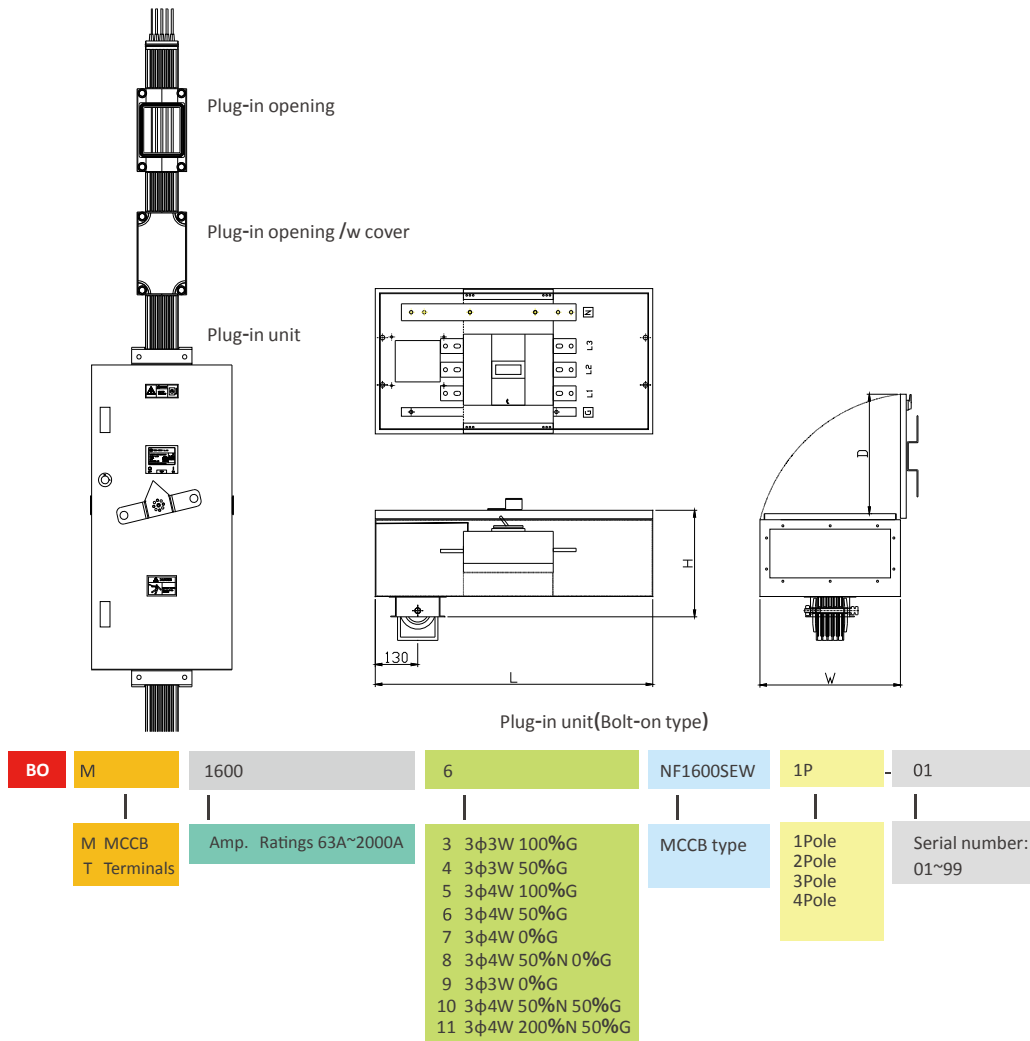

Dimensions

Plug-in Amp. Ratings		63A	100A	225A	250A	400A	630A	800A	1000A	1200A	1600A	2000A
L	mm	500	500	500	500	700	850	850	1100	1100	1100	1300
W	mm	300	300	300	300	300	430	430	430	530	530	530
H	mm	270	270	270	270	300	330	330	380	380	380	560
D	mm	280	280	280	280	280	410	410	410	510	510	510
IP Rating		IP42	IP42	IP42	IP42	IP42	IP42	IP42	IP42	IP42	IP42	IP42
Weight	Kg	17	19	23	24	27	55	58	65	70	80	80

Note: A standard plug-in unit is rated IP42. For customers needing higher protection rating, IP54 is available on demand

End Cable box

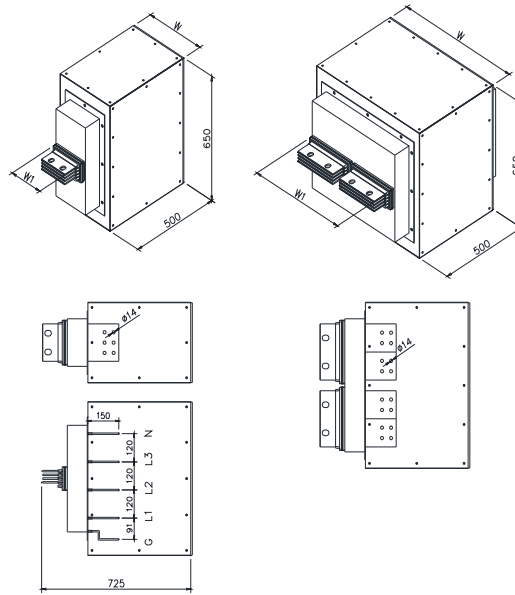

Figure 1

Figure 2

BL	C	08	6	EB	Dimension A
	C Cu A Al	04 400A 20 2000A 06 600A 25 2500A 08 800A 32 3200A 10 1000A 40 4000A 12 1250A 50 5000A 15 1500A 64 6400A 16 1600A	3 3φ3W 100%G 4 3φ3W 50%G 5 3φ4W 100%G 6 3φ4W 50%G 7 3φ4W 0%G 8 3φ4W 50%N 0%G 9 3φ3W 0%G 10 3φ4W 50%N 50%G 11 3φ4W 200%N 50%G	EB End tap box	725

※For outdoor junction boxes, additional technical diagrams are required for compiling the dimensions

Copper

Busway Ratings		400A	600A	800A	1000A	1250A	1600A	2000A	2500A	3200A	4000A	5000A
W	mm	205	220	233	260	300	340	380	420	545	625	705
W1	mm	55	70	83	110	150	190	230	270	395	475	555
IP Rating		IP54	IP54	IP54	IP54	IP54	IP54	IP54	IP54	IP54	IP54	IP54
Figure		1	1	1	1	1	1	1	1	2	2	2

Aluminum

Busway Ratings		250A	400A	600A	800A	1000A	1250A	1500A	1600A	2000A	2500A	3200A	4000A
W	mm	220	233	260	280	300	340	380	420	420	625	705	705
W1	mm	70	83	110	130	150	190	230	270	270	475	555	555
IP Rating		IP54	IP54	IP54	IP54	IP54	IP54	IP54	IP54	IP54	IP54	IP54	IP54
Figure		1	1	1	1	1	1	1	1	1	2	2	2

Central Cable box

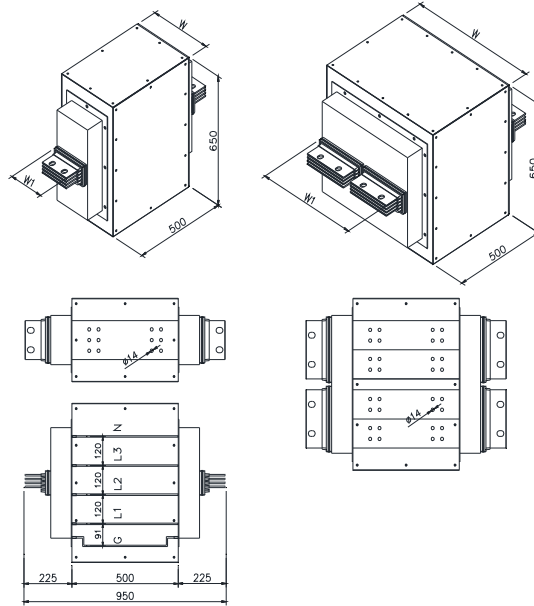

Figure 1

Figure 2

BL	C	08	6	CB	Dimension A
	C Cu A Al	04 400A 20 2000A 06 600A 25 2500A 08 800A 32 3200A 10 1000A 40 4000A 12 1250A 50 5000A 15 1500A 64 6400A 16 1600A	3 3φ3W 100%G 4 3φ3W 50%G 5 3φ4W 100%G 6 3φ4W 50%G 7 3φ4W 0%G 8 3φ4W 50%N 0%G 9 3φ3W 0%G 10 3φ4W 50%N 50%G 11 3φ4W 200%N 50%G	CB Center tap box	950

※For outdoor junction boxes, additional technical diagrams are required for compiling the dimensions

Copper

Busway Ratings		400A	600A	800A	1000A	1250A	1600A	2000A	2500A	3200A	4000A	5000A
W	mm	205	220	233	260	300	340	380	420	545	625	705
W1	mm	55	70	83	110	150	190	230	270	395	475	555
IP Rating		IP54	IP54	IP54	IP54	IP54	IP54	IP54	IP54	IP54	IP54	IP54
Figure		1	1	1	1	1	1	1	1	2	2	2

Aluminum

Busway Ratings		250A	400A	600A	800A	1000A	1250A	1500A	1600A	2000A	2500A	3200A	4000A
W	mm	220	233	260	280	300	340	380	420	420	625	705	705
W1	mm	70	83	110	130	150	190	230	270	270	475	555	555
IP Rating		IP54	IP54	IP54	IP54	IP54	IP54	IP54	IP54	IP54	IP54	IP54	IP54
Figure		1	1	1	1	1	1	1	1	1	2	2	2

Joint expansion

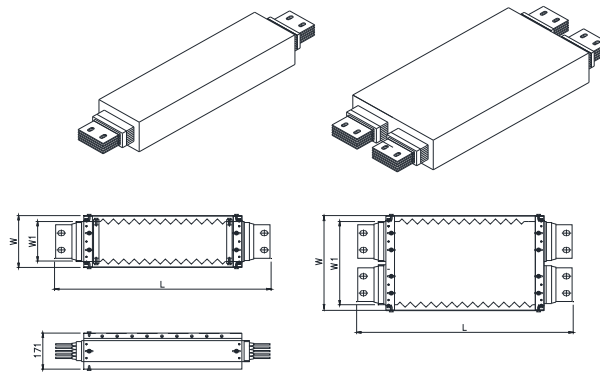

Figure 1

Figure 2

BL	C	08	6	EF	Dimension A
	C Cu A Al	04 400A 20 2000A 06 600A 25 2500A 08 800A 32 3200A 10 1000A 40 4000A 12 1250A 50 5000A 15 1500A 64 6400A 16 1600A	3 3φ3W 100%G 4 3φ3W 50%G 5 3φ4W 100%G 6 3φ4W 50%G 7 3φ4W 0%G 8 3φ4W 50%N 0%G 9 3φ3W 0%G 10 3φ4W 50%N 50%G 11 3φ4W 200%N 50%G	EF Expansion fitting	1200

Where the straight length of busways exceeds 50m, a joint expansion element is required
 Where busways have to pass a building expansion joint, joint expansion elements are required
 Extension range: Busway length +/-40mm moving range

Copper

Busway Ratings		400A	600A	800A	1000A	1250A	1600A	2000A	2500A	3200A	4000A	5000A
W	mm	126	126	139	166	206	246	286	326	451	531	611
W1	mm	55	70	83	110	150	190	230	270	395	475	555
L	mm	1200	1200	1200	1200	1200	1200	1200	1200	1200	1200	1200
IP Rating		IP68	IP68	IP68	IP68	IP68	IP68	IP68	IP68	IP68	IP68	IP68
Figure		1	1	1	1	1	1	1	1	2	2	2

Aluminum

Busway Ratings		250A	400A	600A	800A	1000A	1250A	1500A	1600A	2000A	2500A	3200A	4000A
W	mm	126	139	166	186	206	246	286	326	326	531	611	611
W1	mm	70	83	110	130	150	190	230	270	270	475	555	555
L	mm	1200	1200	1200	1200	1200	1200	1200	1200	1200	1200	1200	1200
IP Rating		IP68	IP68	IP68	IP68	IP68	IP68	IP68	IP68	IP68	IP68	IP68	IP68
Figure		1	1	1	1	1	1	1	1	1	2	2	2

Element code

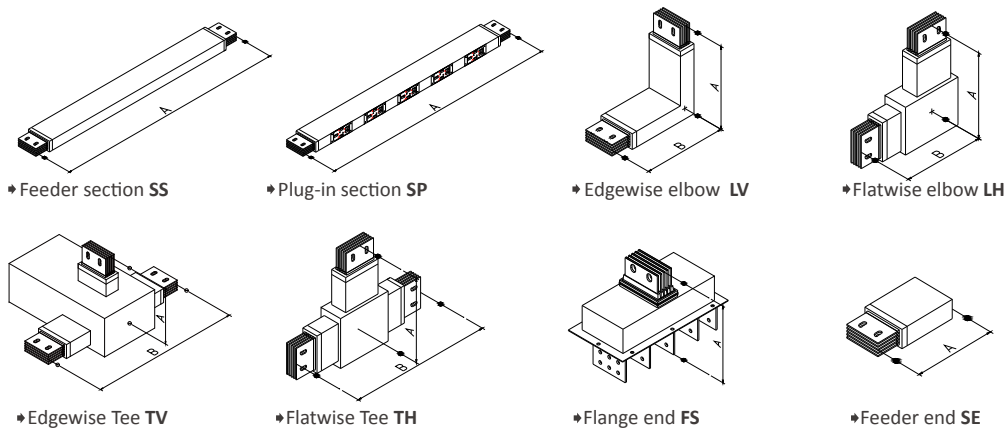

BL	C	08	6	SS	Dimension A x B x C
	C Cu A Al	04 400A 20 2000A 06 600A 25 2500A 08 800A 32 3200A 10 1000A 40 4000A 12 1250A 50 5000A 15 1500A 64 6400A 16 1600A	3 3φ3W 100%G 4 3φ3W 50%G 5 3φ4W 100%G 6 3φ4W 50%G 7 3φ4W 0%G 8 3φ4W 50%N 0%G 9 3φ3W 0%G 10 3φ4W 50%N 50%G 11 3φ4W 200%N 50%G	SS Feeder section SP Plug-in section LV Edgewise elbow LH Flatwise elbow CH Flat to Edge CV Edge to Flat TV Edgewise Tee TH Flatwise Tee FS Flange end SE Feeder end	

Copper

Busway Ratings		400A	600A	800A	1000A	1250A	1600A	2000A	2500A	3200A	4000A	5000A
Feeder section	A	4200	4200	4200	4200	4200	4200	4200	4200	4200	4200	4200
Plug-in section	A mm	4200	4200	4200	4200	4200	4200	4200	4200	4200	4200	4200
Edgewise elbow	AxB mm	250x250	250x250	250x250	250x250	250x250	250x250	250x250	250x250	250x250	250x250	250x250
Flatwise elbow	AxB mm	190x190	190x190	190x190	215x215	235x235	255x255	275x275	295x295	360x360	400x400	440x440
Edgewise Tee	AxB mm	200x490	200x520	200x550	200x600	200x680	200x760	200x840	200x920	200x760	200x840	200x920
Flatwise Tee	AxB mm	190x380	190x380	190x380	215x430	235x470	255x510	275x550	295x590	360x720	440x880	440x880
Flange end	A mm	380	380	380	380	380	380	380	380	380	380	380
Feeder end	A mm	250	250	250	250	250	250	250	250	250	250	250

Aluminum

Busway Ratings		250A	400A	600A	800A	1000A	1250A	1500A	1600A	2000A	2500A	3200A	4000A
Feeder section	A	4200	4200	4200	4200	4200	4200	4200	4200	4200	4200	4200	4200
Plug-in section	A mm	4200	4200	4200	4200	4200	4200	4200	4200	4200	4200	4200	4200
Edgewise elbow	AxB mm	250x250	250x250	250x250	250x250	250x250	250x250	250x250	250x250	250x250	250x250	250x250	250x250
Flatwise elbow	AxB mm	190x190	190x190	215x215	225x225	235x235	255x255	275x275	295x295	295x295	400x400	440x440	440x440
Edgewise Tee	AxB mm	200x520	200x550	200x600	200x640	200x680	200x760	200x840	200x920	200x920	200x840	200x920	200x920
Flatwise Tee	AxB mm	190x380	190x380	215x430	225x450	235x470	255x510	275x550	295x590	295x590	400x800	440x880	440x880
Flange end	A mm	380	380	380	380	380	380	380	380	380	380	380	380
Feeder end	A mm	250	250	250	250	250	250	250	250	250	250	250	250

Spring hanger

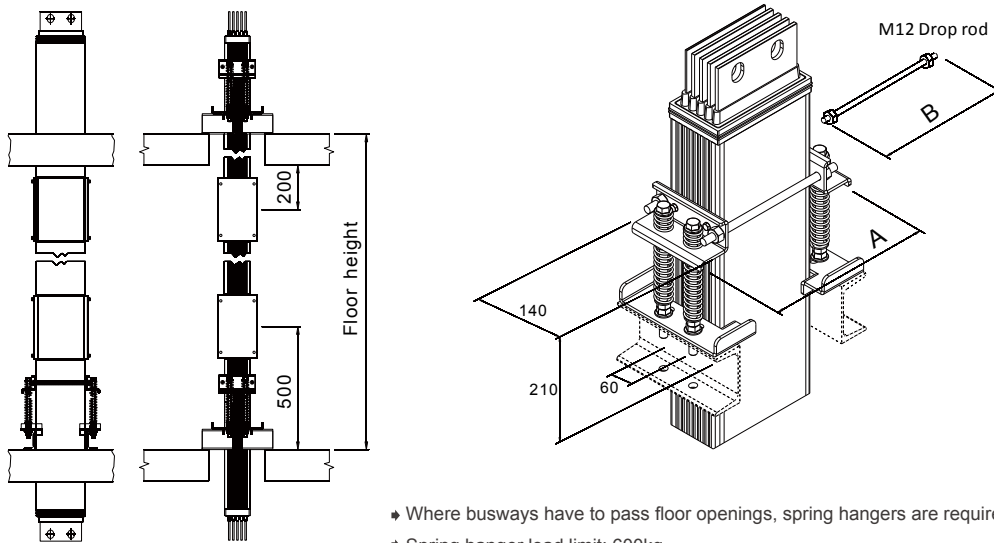

- ◆ Where busways have to pass floor openings, spring hangers are required for sufficient support
- ◆ Spring hanger load limit: 600kg
- ◆ Spring hangers require no adjustment, and can evenly support busway weight in all floors and compensate displacement caused by thermal expansion

Copper

Busway Ratings		400A	600A	800A	1000A	1250A	1600A	2000A	2500A	3200A	4000A	5000A
Models		SH600	SH600	SH600	SH600	SH600	SH600	SH600	SH600	SH600	SH600	SH600
Height 1m/weight	kg	15.0	20.6	25.5	35.7	50.8	65.9	81.0	96.0	131.8	162.0	192.0
Height 3m/weight	kg	45.0	61.8	76.5	107.1	152.4	197.7	243.0	288.0	395.4	486.0	576.0
Height 4m/weight	kg	60.0	82.4	102.0	142.8	203.2	263.6	324.0	384.0	527.2	648.0	768.0
Height 5m/weight	kg	75.0	103.0	127.5	178.5	254.0	329.5	405.0	480.0	659.0	810.0	960.0
Hanger width A	mm	165	180	193	220	260	300	340	380	505	585	665
Drop rod dimension M12xB	mm	105	120	140	160	200	240	280	320	450	530	610
Max. tolerance of height	m	≤5	≤5	≤5	≤5	≤5	≤5	≤5	≤5	≤4	≤3	≤3

Aluminum

Busway Ratings		250A	400A	600A	800A	1000A	1250A	1500A	1600A	2000A	2500A	3200A	4000A
Models		SH600	SH600	SH600	SH600	SH600	SH600	SH600	SH600	SH600	SH600	SH600	SH600
Height 1m/weight	kg	20.6	16.9	22.6	26.9	31.2	32.1	48.3	56.8	56.8	96.6	113.6	113.6
Height 3m/weight	kg	61.8	50.7	67.8	80.7	93.6	96.4	144.9	170.4	170.4	289.8	340.8	340.8
Height 4m/weight	kg	82.4	67.6	90.4	107.6	124.8	128.4	193.2	227.2	227.2	386.4	454.4	454.4
Height 5m/weight	kg	103.0	84.5	113.0	134.5	156.0	160.5	241.5	284.0	284.0	483.0	568.0	568.0
Hanger width A	mm	180	193	220	240	260	300	340	380	380	585	665	665
Drop rod dimension M12xB	mm	120	140	160	180	200	240	280	320	320	530	610	610
Max. tolerance of height	m	≤5	≤5	≤5	≤5	≤5	≤5	≤5	≤5	≤5	≤5	≤5	≤5

Wall/Floor Flange

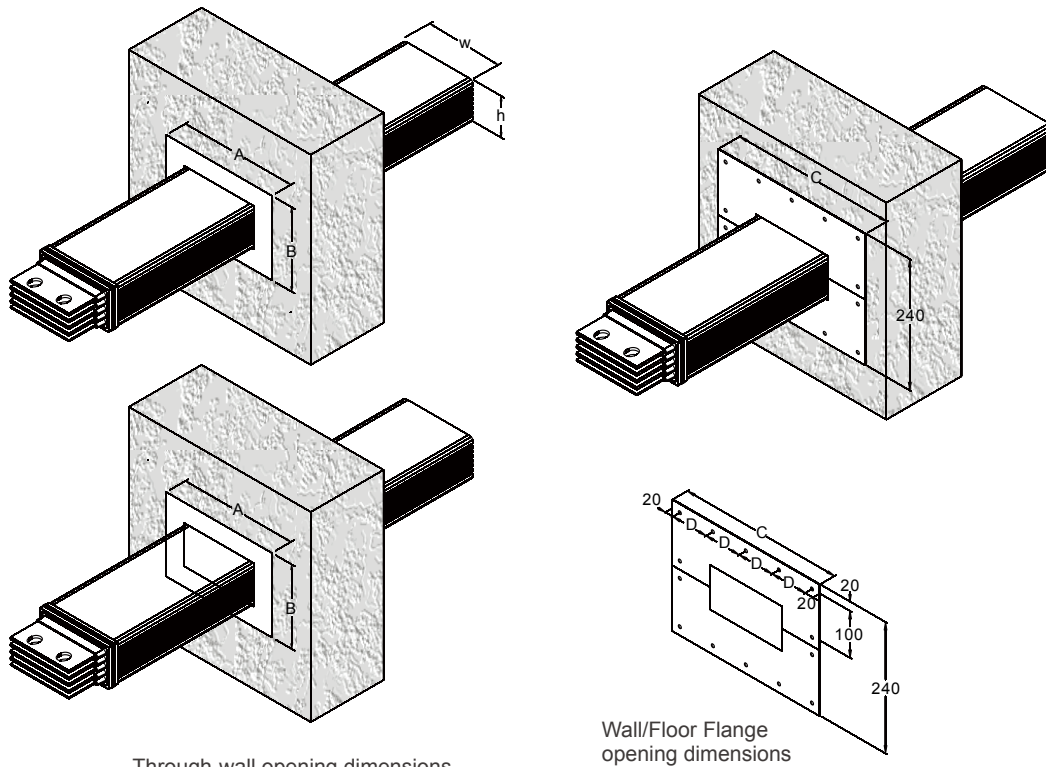

Through-wall opening dimensions

Wall/Floor Flange opening dimensions

Copper

Busway Ratings		400A	600A	800A	1000A	1250A	1600A	2000A	2500A	3200A	4000A	5000A
Models		WF0600	WF0804	WF1006	WF1208	WF1612	WF2000	WF2516	WF3220	WF4025	WF5032	WF6440
h x w	mm	100x55	100x70	100x83	100x110	100x150	100x190	100x230	100x270	100x395	100x475	100x555
A	mm	155	170	183	210	250	290	330	370	495	575	655
B	mm	200	200	200	200	200	200	200	200	200	200	200
C	mm	258	272	286	313	352	392	432	472	600	680	760
D	mm	109	116	123	91	104	88	98	108	112	128	90

Aluminum

Busway Ratings		250A	400A	600A	800A	1000A	1250A	1500A	1600A	2000A	2500A	3200A	4000A
Models		WF0804	WF1006	WF1208	WF0010	WF1612	WF2000	WF2516	WF3220	WF3220	WF5032	WF6440	WF6440
h x w	mm	100x70	100x83	100x110	100x130	100x150	100x190	100x230	100x270	100x270	100x475	100x555	100x555
A	mm	170	183	210	230	250	290	330	370	370	575	655	655
B	mm	200	200	200	200	200	200	200	200	200	200	200	200
C	mm	272	286	313	334	352	392	432	472	472	680	760	760
D	mm	116	123	91	98	104	88	98	108	108	128	90	90